

ENERGYLINE PRO INVERTER

**POMPE A CHALEUR POUR PISCINE
SWIMMING POOL HEAT PUMP UNIT
UNIDAD DE BOMBA DE CALOR PARA PISCINAS
BOMBA DE AQUECIMENTO PARA PISCINAS
HEIZPUMPENANLAGE FÜR EIN SCHWIMMBECKEN
ZWEMBAD WARMTEPOMP
UNITÀ DI RISCALDAMENTO A POMPA DI CALORE PER PISCINE
VARMEPUMPE TIL SVØMMEBASSENG
ТЕПЛОВОЙ НАСОС ДЛЯ ПЛАВАТЕЛЬНОГО БАСЕЙНА**



**Manuel d'instructions et d'installation
Installation & Instruction Manual
Manual de Instalación e Instrucciones
Manual de instalação e de instruções
Einbau- & Anleitungshandbuch
Installatie- en bedieningshandleiding
Manuale d'Uso e di Installazione
Installerings- og brukerveiledning
Руководство по монтажу и эксплуатации**

ISENPINVR32

ENERGYLINE PRO INVERTER

POMPE A CHALEUR POUR PISCINE



Manuel d'instructions et d'installation

SOMMAIRE

1. PRÉFACE	1
2. CARACTÉRISTIQUES TECHNIQUES	4
2.1 Données techniques de la pompe à chaleur	4
2.2 Plage de fonctionnement	5
2.3 Dimensions	6
3. INSTALLATION ET RACCORDEMENT	7
3.1 Schéma de Principe	7
3.2 Pompe à chaleur	7
3.3 Raccordement hydraulique	8
3.4 Raccordement Électrique	9
3.5 Premier démarrage	10
3.6 Réglage du débit d'eau	12
4. INTERFACE UTILISATEUR	13
4.1 Présentation générale	13
4.2 Réglage Date et Heure	14
4.3 Réglage du Timer	14
4.4 Visualisation et réglage du point de consigne	16
4.5 Verrouillage et déverrouillage de l'écran tactile.	17
4.6 Activation et réglage du mode SILENCE	18
5. ENTRETIEN ET HIVERNAGE	21
5.1 Entretien	21
5.2 Hivernage	21
6. ANNEXES	22
6.1 Schémas électriques	22
6.2 Raccordements priorité chauffage Pompe Monophasé	24
6.3 Vues éclatées et pièces détachées	26
6.4 Guide de dépannage	28
6.5 Base d'enregistrement	31
6.6 Garantie	32

À lire attentivement et à conserver pour une consultation ultérieure.

Ce document doit être remis au propriétaire de la piscine et doit être conservé par celui-ci en lieu sûr.

1. PRÉFACE

Nous vous remercions d'avoir acheté cette pompe à chaleur de piscine Hayward. La pompe à chaleur Hayward FULL INVERTER a été conçue selon des normes strictes de fabrication pour satisfaire les plus hauts niveaux de qualité requis.

Les pompes à chaleur Hayward vont vous offrir d'exceptionnelles performances tout au long de votre saison de baignade en adaptant la puissance, la consommation électrique et le niveau sonore au besoin de chauffage de votre piscine grâce à la logique de contrôle FULL INVERTER.



Lisez attentivement les consignes de ce manuel avant d'utiliser l'appareil.

Les pompes à chaleur Hayward sont exclusivement destinées à chauffer l'eau de piscine, ne pas utiliser ce matériel à d'autres fins.

Le présent manuel inclut toutes les informations nécessaires concernant l'installation, l'élimination des dysfonctionnements et l'entretien.

Lisez attentivement ce manuel avant d'ouvrir l'unité, ou de réaliser des opérations d'entretien sur celle-ci. Le fabricant de ce produit ne sera en aucun cas tenu responsable en cas de blessure d'un utilisateur ou d'un endommagement de l'unité suite à d'éventuelles erreurs lors de l'installation, de l'élimination des dysfonctionnements, ou d'un entretien inutile. Il est primordial de suivre à tout moment les instructions spécifiées dans ce manuel.

Toute recommandation non suivie annule la garantie.

1. PRÉFACE (suite)



Consignes de sécurité



Cet appareil contient du R32.

Ne jamais utiliser un réfrigérant autre que du R32. Tout autre corps gazeux mélangé avec le R32 risque de provoquer des pressions anormalement élevées pouvant conduire à une panne ou à une rupture de tuyaux et blesser des personnes.

Lors de réparations ou d'opérations de maintenance ne jamais utiliser des tubes de cuivre dont l'épaisseur est inférieure à 0,8 mm.

La pompe à chaleur étant sous pression ne jamais percer les tuyaux ni tenter de faire une brasure. Il y a risque d'explosion.

Ne jamais exposer l'appareil à des flammes, des étincelles ou autre sources d'allumage. Il pourrait exploser et entraîner des blessures graves voire mortelles.

- En cas de stockage la pompe à chaleur doit être stockée dans une pièce bien ventilée et d'une surface au sol de plus de A_{\min} (m²) donnée par la formule suivante : $A_{\min} = (M/(2.5 \times 0.22759 \times h_0))^2$
M est la charge de réfrigérant dans l'appareil en kg et h0 est la hauteur de stockage. Pour un stockage au sol h0 = 0,6 m.
- La pompe à chaleur est exclusivement prévue pour une installation à l'extérieur des bâtiments.
- L'unité doit être installée par un personnel qualifié.
- Ne pas installer la pompe à chaleur sur un support risquant d'amplifier les vibrations de l'unité.
- Vérifier que le support prévu pour l'unité est convenablement dimensionné pour le poids de l'appareil.
- Ne pas installer la pompe à chaleur dans un endroit susceptible d'amplifier son niveau sonore ou dans un endroit où le bruit de l'unité risquerait de gêner le voisinage.
- Tous les raccordements électriques doivent être effectués par un électricien professionnel qualifié et selon les normes en vigueur dans le pays d'installation cf § 3.4.
- Couper l'alimentation principale et le sectionneur avant tous travaux électriques. Tout oubli peut être cause d'électrocution.

1. PRÉFACE (suite)

- Avant l'installation vérifier que le câble de terre n'est pas coupé ou déconnecté. Raccorder et serrer convenablement le câble d'alimentation électrique. Si la connexion est mauvaise, des parties électriques peuvent être endommagées.
- L'exposition de la pompe à chaleur à l'eau ou à un milieu humide risque de provoquer une électrocution. Soyez très vigilant.
- Si vous détectez tout défaut ou situation anormale, n'installez pas la pompe à chaleur et contactez immédiatement votre revendeur.
- L'entretien et les différentes opérations doivent être réalisés à la fréquence et aux moments recommandés, tel que spécifié dans le présent manuel.
- Les réparations doivent être effectuées par un personnel qualifié.
- N'utilisez que des pièces détachées d'origine.
- Ne jamais utiliser un autre procédé de nettoyage que celui préconisé dans ce manuel.

Informations importantes concernant le réfrigérant utilisé

Ce produit contient des gaz à effet de serre fluorés encadrés par le protocole de Kyoto. Ne libérez pas ces gaz dans l'atmosphère.

Type de réfrigérant : R32

Valeur GWP(1) : 675, Valeur basée sur le 4ème rapport du GIEC.

La quantité de réfrigérant basée sur la réglementation F Gaz 517/2014 est indiquée sur la plaque signalétique de l'unité.

Des inspections périodiques de fuite de réfrigérant peuvent être exigées en fonction de la législation européenne ou local. Veuillez contacter votre distributeur local pour plus d'informations.

(1) Potentiel de réchauffement global

2. CARACTÉRISTIQUES TECHNIQUES

2.1 Données techniques de la pompe à chaleur

Modèles	ENERGYLINE PRO INVERTER	ENPI4M	ENPI6M
Tension d'alimentation	V	220V-240V ~ / 1ph / 50Hz	
Réfrigérant	/	R32	
Charge	kg	0,50	0,65
Masse en teqCO ₂	/	0,34	0,44
Fréquence du contrôle de fuite	/	Aucune exigence mais conseillé de façon annuelle	
Capacité de chauffage Min--Max ^(a)	kW	2,50--9,73	3,20--11,9
Puissance électrique absorbée Min--Max ^(a)	kW	0,20--1,34	0,28--1,68
Courant nominal de service Min--Max ^(a)	A	1,33--6,02	1,34--7,32
COP Max--Min ^(a)	/	12,32--7,12	11,51--7,10
Capacité de chauffage Min--Max ^(b)	kW	1,71--7,60	2,70--9,70
Puissance électrique absorbée Min--Max ^(b)	kW	0,27--1,49	0,44--1,88
COP Max--Min ^(b)	/	6,40--5,1	6,10--5,55
Courant maximum de service (CMS)	A	7,30	8,90
Calibre du fusible	aM	8	10
Disjoncteur courbe D	D	8	10
Courant de démarrage	A	< CMS	< CMS
Raccordement hydraulique	mm	50mm	
Débit d'eau nominal ^(a)	m ³ /h	4,20	5,10
Perte de charge sur l'eau max	kPa	3,3	4,5
Compresseur	/	DC Inverter Mitsubishi	DC Inverter Highly
Type	/	Double Rotatif	Double Rotatif
Quantité	/	1	
Résistance d'enroulement à 20°C	Ohm	1,91	0,788
Ventilateur	/	Axial	
Quantité	/	1	
Diamètre	mm	405	510
Nombre de pale	/	3	
Moteur	/	DC Inverter	
Quantité	/	1	1
Vitesse de rotation	Tr/min	500--700	500-650
Vitesse Mode Silence	Tr/min	300	400
Niveau de pression acoustique à 1m	dB(A)	33--41	33-41
Niveau de pression acoustique à 10m	dB(A)	16--25	16--25
Dimensions nettes de l'unité (L-I-H)	mm	1046/400/768	
Poids	kg	53	65



(a) Air sec 27°C - Humidité relative 78% - Température d'entrée d'eau 26°C.

(b) Air sec 15°C - Humidité relative 71% - Température d'entrée d'eau 26°C

2. CARACTÉRISTIQUES TECHNIQUES (suite)

2.2 Plage de fonctionnement

Utiliser la pompe à chaleur dans les plages suivantes de températures et d'humidité pour assurer un fonctionnement sûr et efficace.

	Mode chauffage 	Mode Refroidissement 
Température extérieure	-12°C – +35°C	+7°C – +43°C
Température d'eau	+12°C – +40°C	+8°C – +40°C
Humidité relative	< 80%	< 80%
Plage de réglage point de consigne	+15°C – +32°C	+8°C – +32°C



Si la température ou l'humidité ne correspond pas à ces conditions, des dispositifs de sécurité peuvent se déclencher et la pompe à chaleur peut ne plus fonctionner.



La température maximum de chauffage est limitée à +32° Celsius afin d'éviter la détérioration des liners. Hayward décline toutes responsabilités dans le cas d'une utilisation au delà des +32°C.

2. CARACTERISTIQUES TECHNIQUES (suite)

2.3 Dimensions

Modèles :

ENPI4M / ENPI6M

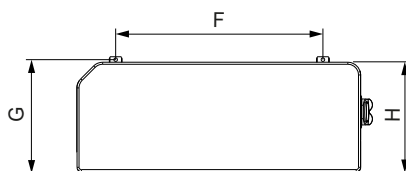
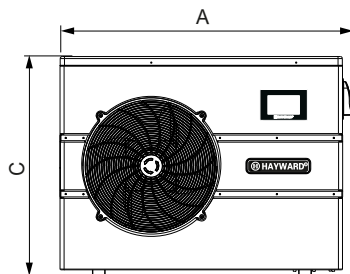
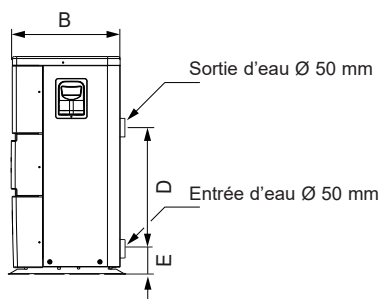

Unité : mm

Repère \ Modèle	ENPI4M / ENPI6M
A	1046
B	400
C	768
D	350
E	110
F	615
G	428
H	400

3. INSTALLATION ET RACCORDEMENT

3.1 Schéma de Principe

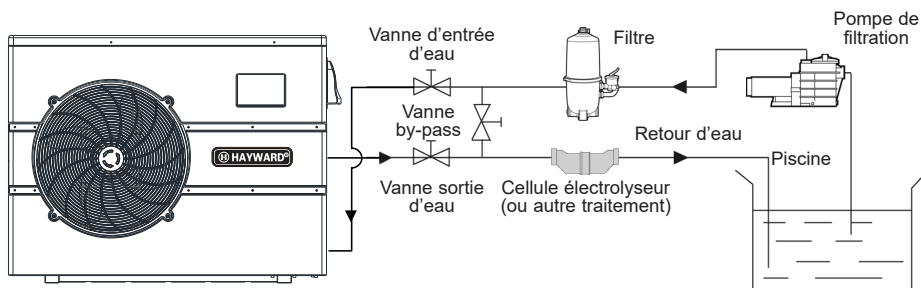

Note : La pompe à chaleur est fournie sans aucun équipement de traitement ou de filtration. Les éléments présentés sur le schéma sont des pièces à fournir par l'installateur.

3.2 Pompe à chaleur



Placer la pompe à chaleur à l'extérieur et en dehors de tout local technique fermé.

Placée sous abri, les distances minimum prescrites ci-dessous doivent être respectées afin d'éviter tout risque de recirculation d'air et une dégradation des performances globales de la pompe à chaleur.

Unité : mm

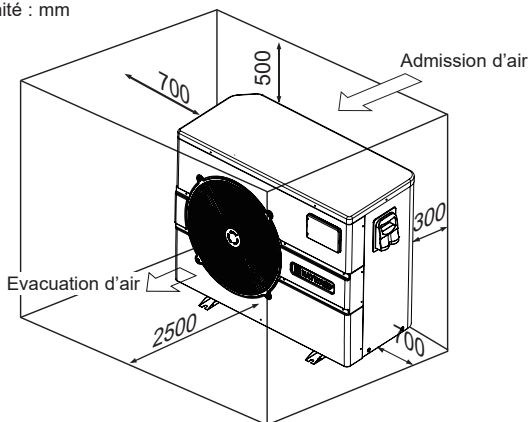

3. INSTALLATION ET RACCORDEMENT (suite)



Installer de préférence la pompe à chaleur sur une dalle béton désolidarisée ou une chaise de fixation prévue à cet effet et monter la pompe à chaleur sur les silentblochs fournis (visserie et rondelles non fournies).

Distance maximale d'installation entre la pompe à chaleur et la piscine 15 mètres.

Longueur totale aller-retour des canalisations hydrauliques 30 mètres. Isoler les canalisations hydrauliques de surface et enterrées.

La pompe à chaleur doit être installée à une distance minimum du bassin conformément à la NF C 15-100 (soit à 3,5 m du plan d'eau pour la France) ou conformément aux normes d'installation en vigueur dans les autres pays.

Ne pas installer la pompe à chaleur à proximité d'une source de chaleur.

En cas d'installation dans des régions neigeuses il est conseillé d'abriter la machine afin d'éviter une accumulation de neige sur l'évaporateur.

3.3 Raccordement hydraulique

La pompe à chaleur est fournie avec deux raccords union Ø 50 mm. Utiliser du tube PVC pour canalisation hydraulique Ø 50 mm. Raccorder l'entrée d'eau de la pompe à chaleur à la conduite venant du groupe de filtration puis raccorder la sortie d'eau de la pompe à chaleur à la conduite d'eau allant au bassin (cf schéma ci-dessous).

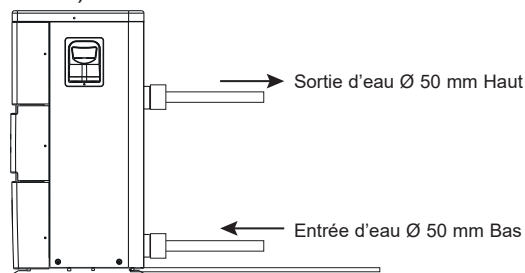

Installer une vanne dite "by-pass" entre l'entrée et la sortie de la pompe à chaleur.



Si un distributeur automatique ou un électrolyseur est utilisé, il doit impérativement être installé après la pompe à chaleur dans le but de protéger le condenseur Titane contre une concentration trop importante de produit chimique.



Veillez à bien installer la vanne by-pass et les raccords union fournis au niveau de l'entrée et de la sortie d'eau de l'unité, afin de simplifier la purge durant la période hivernale, d'en faciliter l'accès ou son démontage pour l'entretien.

3. INSTALLATION ET RACCORDEMENT (suite)

3.4 Raccordement Électrique



L'installation électrique et le câblage de cet équipement doivent être conformes aux règles d'installation locales en vigueur.

F	NF C15-100	GB	BS7671:1992
D	DIN VDE 0100-702	EW	EVHS-HD 384-7-702
A	ÖVE 8001-4-702	H	MSZ 2364-702/1994/MSZ 10-553 1/1990
E	UNE 20460-7-702 1993, RECBT ITC-BT-31 2002	M	MSA HD 384-7-702.S2
IRL	Wiring Rules + IS HD 384-7-702	PL	PN-IEC 60364-7-702:1999
I	CEI 64-8/7	CZ	CSN 33 2000 7-702
LUX	384-7.702 S2	SK	STN 33 2000-7-702
NL	NEN 1010-7-702	SLO	SIST HD 384-7-702.S2
P	RSIUEE	TR	TS IEC 60364-7-702



Vérifiez que l'alimentation électrique disponible et la fréquence du réseau correspondent au courant de fonctionnement requis, en prenant en considération l'emplacement spécifique de l'appareil, et le courant nécessaire pour alimenter tout autre appareil connecté au même circuit.

ENPI4M 230V ~ +/- 10 % 50 Hz 1 Phase

ENPI6M 230V ~ +/- 10 % 50 Hz 1 Phase

Observez le schéma de câblage correspondant en annexe.

Le boîtier de raccordement se trouve du côté droit de l'unité. Trois connexions sont destinées à l'alimentation électrique, et deux à la commande de la pompe de filtration (Asservissement).

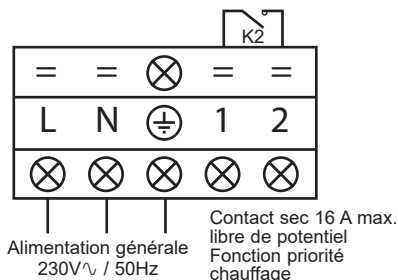

3. INSTALLATION ET RACCORDEMENT (suite)



La ligne d'alimentation électrique doit être dotée, de manière appropriée, d'un dispositif de protection fusible de type alimentation moteur (aM) ou disjoncteur courbe D ainsi que d'un disjoncteur différentiel 30mA (voir tableau après).

Modèles		ENPI4M	ENPI6M
Alimentation électrique	V/Ph/Hz	230V~/ 50Hz	230V~/ 50Hz
Calibre fusible type aM	A	8 aM	10 aM
Disjoncteur courbe D	A	8 D	10 D
Section de câble	mm ²	3G 2,5	3G 2,5



Utiliser un câble d'alimentation Type RO2V/R2V ou équivalent.





Les sections de câble sont données pour une longueur maximum de 25 m, elles doivent néanmoins être vérifiées et adaptées en fonction des conditions d'installation.



Prenez toujours garde d'arrêter l'alimentation principale avant d'ouvrir la boîte de commande électrique.

3.5 Premier démarrage

Procédure de démarrage - une fois l'installation terminée, suivez et respectez les étapes suivantes :

- 1) Faites pivoter les ventilateurs à la main afin de vérifier qu'il peut tourner librement, et que l'hélice est fixée correctement sur l'arbre du moteur.
- 2) Assurez-vous que l'unité est connectée correctement à l'alimentation principale (voir le schéma de câblage en annexe).
- 3) Activez la pompe de filtration.
- 4) Vérifiez que toutes les vannes d'eau sont ouvertes, et que l'eau s'écoule vers l'unité avant de passer en mode chauffage ou refroidissement.
- 5) Vérifiez que le tuyau de purge des condensats est fixé correctement, et ne présente aucune obstruction.
- 6) Activez l'alimentation électrique destinée à l'unité, puis appuyez sur le bouton Marche/Arrêt  sur le panneau de commande.
- 7) Assurez-vous que le signal d'alarme () ne s'allume pas en rouge. Le cas échéant voir le guide de dépannage (voir § 6.4).

3. INSTALLATION ET RACCORDEMENT (suite)

- 8) Fixez le débit d'eau à l'aide de la vanne by-pass (voir § 3.6 et 2.1), tel que prévu respectivement pour chaque modèle, de manière à obtenir une différence de température Entrée/Sortie de 2°C.
- 9) Après un fonctionnement de quelques minutes, vérifiez que l'air sortant de l'unité s'est refroidi (entre 5 et 10°).
- 10) L'unité étant en service, désactivez la pompe de filtration. L'unité doit s'arrêter automatiquement et afficher le code d'erreur E03 (voir § 6.4).
- 11) Faites fonctionner l'unité et la pompe de la piscine 24 heures sur 24, jusqu'à ce que la température de l'eau souhaitée soit atteinte. Quand la température d'entrée d'eau atteint la valeur de consigne, l'unité s'arrête. Elle redémarre alors automatiquement (tant que la pompe de la piscine est en service) si la température de la piscine est inférieure d'au moins 0.5°C à la température de consigne.

Contrôleur de débit - L'unité est dotée d'un contrôleur de débit qui active la pompe à chaleur lorsque la pompe de filtration de la piscine est en service, et la désactive lorsque la pompe de la filtration est hors service. Par manque d'eau, le code d'alarme E03 s'affiche sur le régulateur (Voir § 6.4).

Temporisation - l'unité intègre une temporisation de 3 minutes, afin de protéger les composants du circuit de commande, d'éliminer toute instabilité en terme de redémarrage et, toute interférence au niveau du contacteur. Grâce à cette temporisation, l'unité redémarre automatiquement 3 minutes environ après toute coupure du circuit de commande. Même une coupure de courant de courte durée active la temporisation de démarrage.

3. INSTALLATION ET RACCORDEMENT (suite)

3.6 Réglage du débit d'eau

Les vannes d'entrée et de sortie d'eau étant ouvertes, ajuster la vanne dite "by-pass" de façon à obtenir une différence de 2°C entre la température d'entrée et de sortie d'eau (voir schéma de principe § 3.1).

Vous pouvez vérifier le réglage en visualisant les températures entrée/sortie directement sur le panneau de commande.

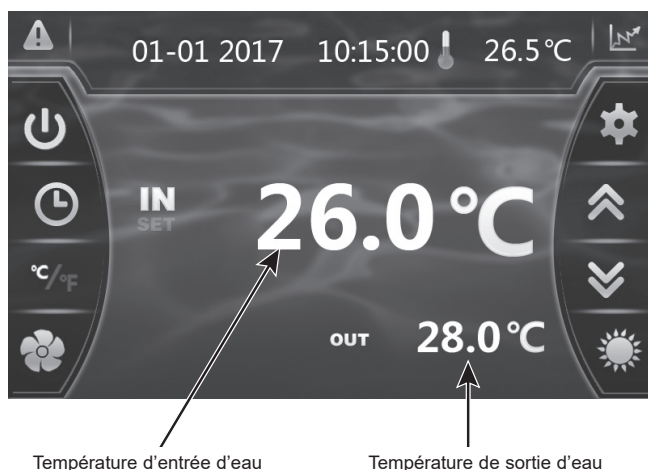

Note : L'ouverture de la vanne dite "by-pass" engendre un débit moins important d'ou une augmentation du ΔT .

La fermeture de la vanne dite "by-pass" engendre un débit plus important d'ou une diminution du ΔT .

4. INTERFACE UTILISATEUR

4.1 Présentation générale

La pompe à chaleur est équipée d'un panneau de commande digital à écran tactile, raccordé électriquement et pré-réglé en usine en mode chauffage.



Légende

1		Alarme (rouge clignotant)
2		Ecran verrouillé
3		Date
4		Heure
5		Température extérieure
6		Base d'enregistrement (Température d'eau et puissance absorbée)
7		Lecture des paramètres et sauvegarde
8		Défilement haut / Augmenter
9		Défilement bas / Diminuer
10		Sélection du mode de fonctionnement
10a		Mode refroidissement

10b		Mode chauffage
10c		Mode automatique
11		Température Sortie d'eau
12		Sélection mode silence
12a		Réglage timer mode silence
12b		Témoin mode silence et activation
13		Conversion °C / °F
14		Température Entrée d'eau
15		Réglage date et heure Timer ON/OFF
16		Dégivrage en cours
17		Marche / Arrêt

4. INTERFACE UTILISATEUR (suite)

Mode OFF

Lorsque la pompe à chaleur est en veille (Mode OFF), le bouton  est grisé.

Mode ON

Lorsque la pompe à chaleur est en fonctionnement ou en régulation (Mode ON) le bouton  s'allume en vert.

4.2 Réglage Date et Heure



 Saisir tous les champs (Jour/Mois/Année, Heure/Minute/Seconde avant de valider, dans le cas contraire les modifications ne seront pas sauvegardées.

4.3 Réglage du Timer

Le réglage de cette fonction est nécessaire dès lors que vous souhaitez faire fonctionner votre pompe à chaleur sur une plus courte période que celle définie par l'horloge de filtration. Ainsi vous pourrez programmer un départ différé et un arrêt anticipé ou simplement interdire une plage horaire de fonctionnement (par exemple la nuit).

Vous avez la possibilité de programmer un Timer Départ et un Timer Arrêt.

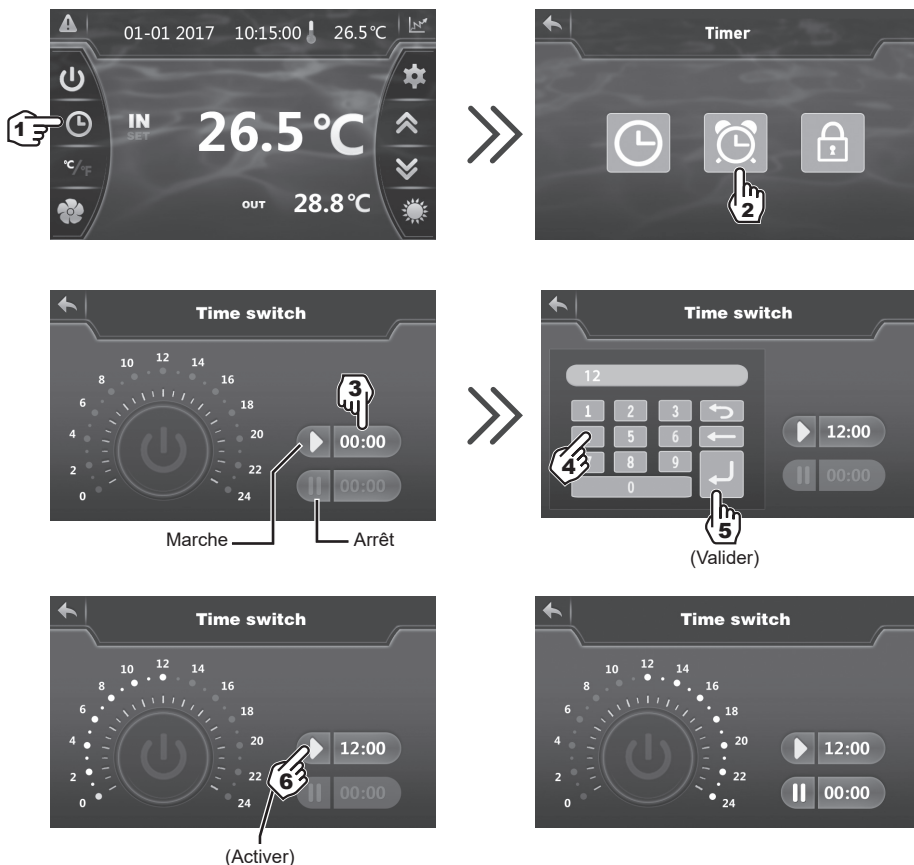

4. INTERFACE UTILISATEUR (suite)



Surbrillance bleue = Activé
Grisé = Désactivé



Le pas de réglage est "d'heure en heure".



- Une fois l'heure de départ réglée, appuyer sur  (étape 6) pour activer le Timer. Le symbole et l'heure passent en surbrillance bleue.
- Reprendre les étapes 3 à 6 pour régler et activer l'heure d'arrêt ( 00:00).
- Les réglages terminés, la plage de fonctionnement de la pompe à chaleur apparaît en surbrillance de couleur verte et la plage d'arrêt en surbrillance de couleur jaune.
- Presser 2 fois sur  pour revenir à l'écran principal.

4. INTERFACE UTILISATEUR (suite)

4.4 Visualisation et réglage du point de consigne



En Mode “OFF” ou “ON”

Presser le bouton  pour afficher le point de consigne puis presser sur 
ou  pour définir le point de consigne souhaité

Valider en appuyant sur , le retour à l'écran principal est automatique



Le réglage s'effectue avec une précision de 0,5 °C.



Il est recommandé de ne jamais dépasser la température de 30°C pour éviter l'altération des liners.

4. INTERFACE UTILISATEUR (suite)

4.5 Verrouillage et déverrouillage de l'écran tactile.

L'écran de contrôle se verrouille automatiquement au bout d'une minute (réglage par défaut).

Il est possible d'ajuster entre 1 et 10 minutes le temps avant que l'écran ne se verrouille automatiquement, ou simplement d'annuler cette fonction.



- 3) Ajuster le temps entre 1 et 10 minutes. La sauvegarde est automatique.
- 4) Presser 2 fois sur pour revenir à l'écran principal.
- 5) Pour désactiver le verrouillage automatique appuyer sur .

Pour déverrouiller l'écran, appuyer (n'importe où) sur l'écran pendant 2 s. Saisir le code "22" et valider en appuyant sur .



4. INTERFACE UTILISATEUR (suite)

4.6 Activation et réglage du mode SILENCE

Le mode silence permet une utilisation de la pompe à chaleur en mode économique et très silencieux lorsque les besoins de chauffage sont faibles (maintien en température du bassin, ou besoin d'avoir un fonctionnement ultra silencieux).

Cette fonction peut être Activée/Désactivée manuellement, ou à l'aide d'un Timer.

Activation Manuelle



Mode Silence activé

4. INTERFACE UTILISATEUR (suite)

Désactivation Manuelle

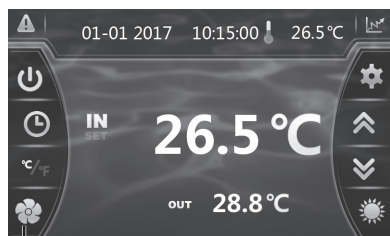

Mode Silence désactivé

Réglage du Timer

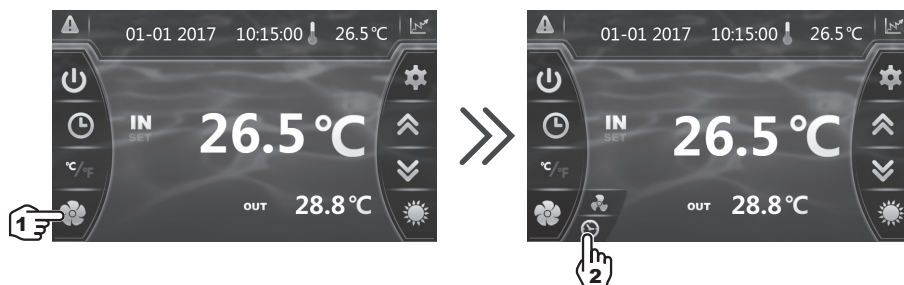

4. INTERFACE UTILISATEUR (suite)

Réglage du Timer (suite)

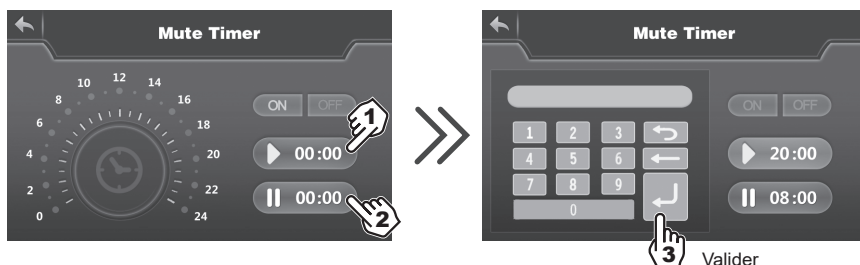

- 1) Heure de début, saisie et validation
- 2) Heure de fin, saisie et validation.
- 3) Valider.



- 4) Activation.
- 5) Désactivation.
- 6) Retour à l'écran principal.



**Le pas de réglage est "d'heure en heure".
Une fois le Timer activé, celui-ci est actif 7 jours sur 7.**

5. ENTRETIEN ET HIVERNAGE

5.1 Entretien

Ces opérations de maintenance doivent être réalisées 1 fois par an afin de garantir la longévité et le bon fonctionnement de la pompe à chaleur.

- Nettoyer l'évaporateur à l'aide d'une brosse souple ou d'un jet d'air ou d'eau (**Attention ne jamais utiliser un nettoyeur haute pression**).
- Vérifier le bon écoulement des condensats.
- Vérifier le serrage des raccords hydrauliques et électriques
- Vérifier l'étanchéité hydraulique du condenseur.
- Faire vérifier l'étanchéité du circuit frigorifique au détecteur de fuite **par un professionnel agréé**.



Avant toute opération de maintenance la pompe à chaleur doit être déconnectée de toute source de courant électrique. Les opérations de maintenance doivent être réalisées uniquement par un personnel qualifié et habilité à manipuler les fluides frigorigènes.

5.2 Hivernage

- Mettre la pompe à chaleur en Mode "OFF".
- Couper l'alimentation de la pompe à chaleur.
- Vider le condenseur à l'aide de la vidange pour éviter tout risque de dégradation (risque important de gel).
- Fermer la vanne "by-pass" et dévisser les raccords unions entrée/sortie.
- Chasser au maximum l'eau stagnante résiduelle du condenseur à l'aide d'un pistolet à air.
- Obturer l'entrée et la sortie d'eau sur la pompe à chaleur pour éviter l'intrusion de corps étranger.
- Couvrir la pompe à chaleur avec la housse d'hivernage prévue à cet effet.



Tout dommage occasionné par un mauvais hivernage entraîne l'annulation de la garantie.

6. ANNEXES

6.1 Schémas électriques

ENPI4M

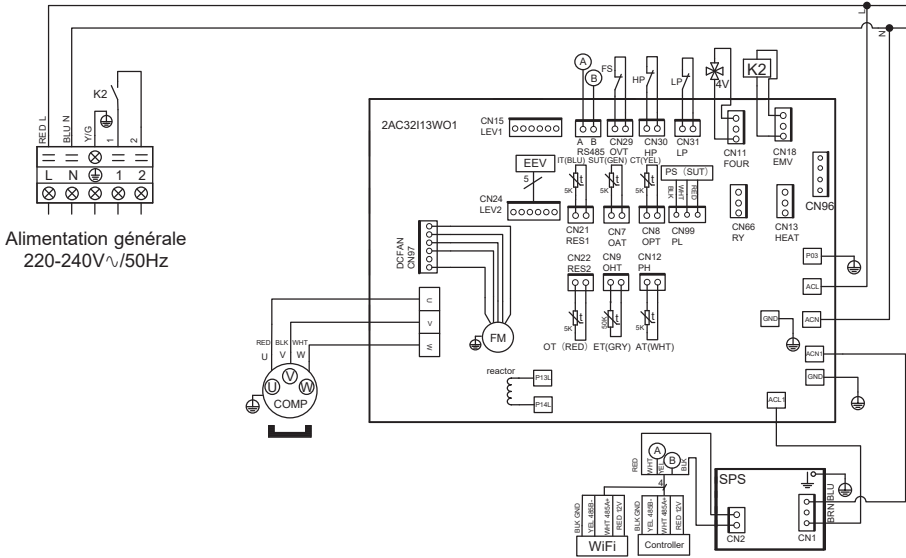

LEGENDE

AT : SONDE DE TEMPÉRATURE D'AIR
COMP : COMPRESSEUR
CT : SONDE TEMPÉRATURE ÉVAPORATEUR
EEV : DÉTENDEUR ÉLECTRONIQUE
FM : MOTEUR VENTILATEUR
FS : DÉTECTEUR PRÉSENCE D'EAU
HP : PRESSOSTAT HAUTE PRESSION
IT : SONDE DE TEMPÉRATURE ENTRÉE D'EAU

LP : PRESSOSTAT BASSE PRESSION
OT : SONDE DE TEMPÉRATURE SORTIE D'EAU
SUT : SONDE DE TEMPÉRATURE D'ASPIRATION
4V : VANNE 4 VOIES
K2 : CONTACT SEC MAX. 16 A
ET : SONDE TEMPÉRATURE REFOULEMENT
PS : CAPTEUR DE PRESSION

6. ANNEXES (suite)

ENPI6M

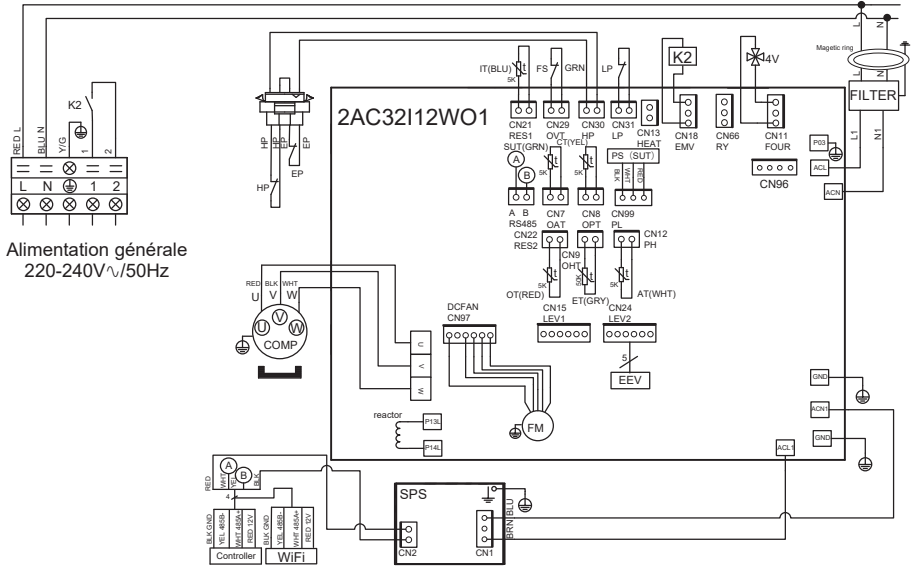

LEGENDE

- | | |
|---|--|
| AT : SONDE DE TEMPÉRATURE D'AIR | LP : PRESSOSTAT BASSE PRESSION |
| COMP : COMPRESSEUR | OT : SONDE DE TEMPÉRATURE SORTIE D'EAU |
| CT : SONDE TEMPÉRATURE ÉVAPORATEUR | SUT : SONDE DE TEMPÉRATURE D'ASPIRATION |
| EEV : DÉTENDEUR ÉLECTRONIQUE | 4V : VANNE 4 VOIES |
| FM : MOTEUR VENTILATEUR | K2 : CONTACT SEC MAX. 16 A |
| FS : DÉTECTEUR PRÉSENCE D'EAU | ET : SONDE TEMPÉRATURE REFOULEMENT |
| HP : PRESSOSTAT HAUTE PRESSION | PS : CAPTEUR DE PRESSION |
| IT : SONDE DE TEMPÉRATURE ENTRÉE D'EAU | |

6. ANNEXES (suite)

6.2 Raccordements priorité chauffage Pompe Monophasé

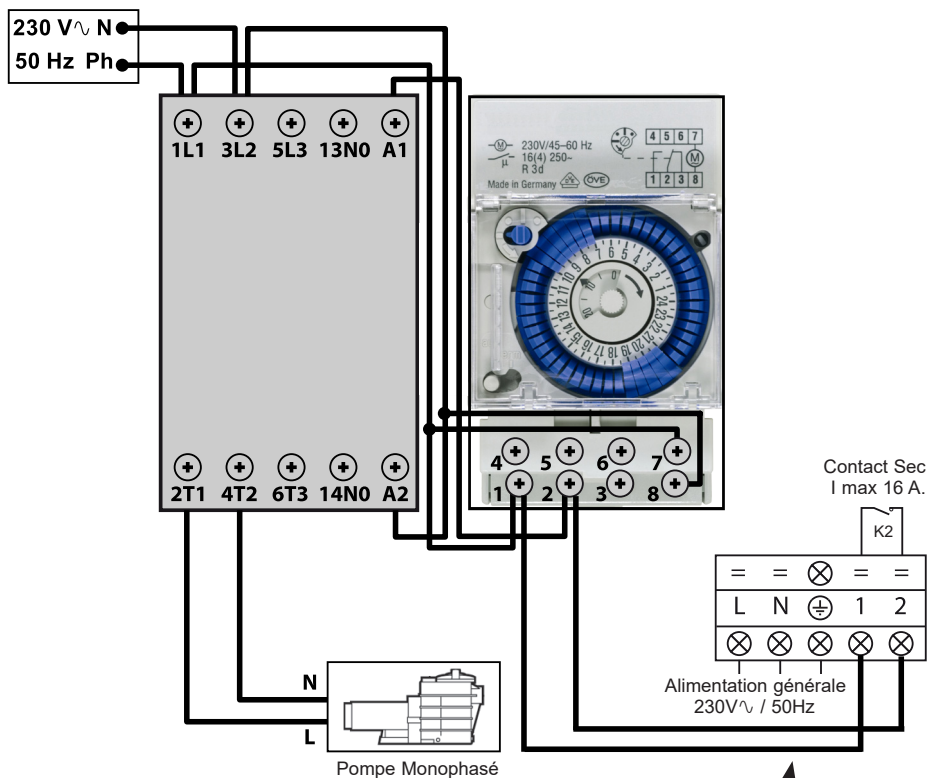

Les bornes 1-2 délivrent un contact sec libre de potentiel, sans polarité 230 V \sim / 50 Hz.
Câbler les bornes 1 et 2 en respectant le câblage indiqué ci-dessus afin d'asservir le fonctionnement de la pompe de filtration par cycle de 2 min. toutes les heures si la température du bassin est inférieure au point de consigne.

 Ne jamais raccorder l'alimentation de la pompe de filtration directement sur les bornes 1 et 2.



Page laissée blanche intentionnellement

6. ANNEXES (suite)

6.3 Vues éclatées et pièces détachées

ENPI4M / ENPI6M

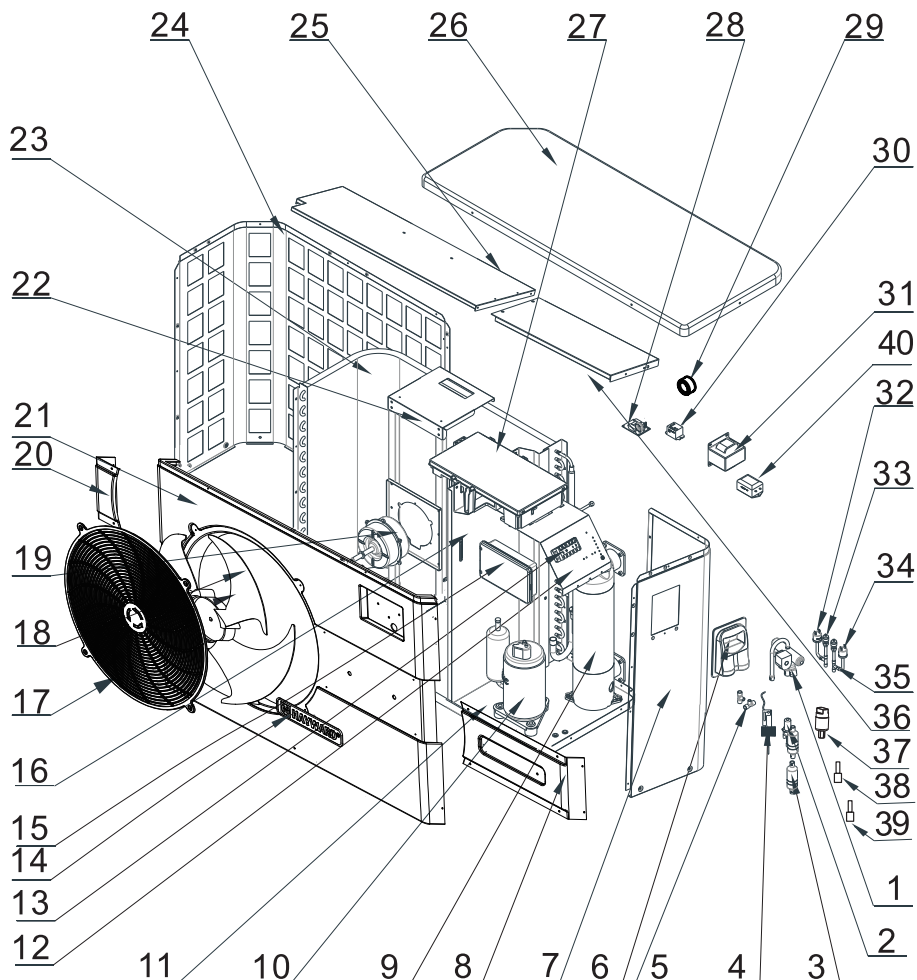

6. ANNEXES (suite)

ENPI4M / ENPI6M

Rep	Désignation	Réf.	ENPI4M	ENPI6M
1	Vanne 4 voies	HWX20041437	✓	✓
2	Détendeur électronique	HWX81000015	✓	n/a
		HWX81000016	n/a	✓
3	Filtre ø9.7-ø9.7 (Ø28)	HWX20041444	✓	✓
4	Détecteur de débit d'eau	HWX83000012	✓	✓
5	Connecteur T ø9.52-2 x ø6.5(T) x 1.0	HWX304030000002	✓	✓
6	Trappe d'accès électrique	HWX320922029	✓	✓
7	Panneau Droit	HWX80700455	✓	✓
8	Panneau décoratif droit	HWX80900089	✓	✓
9	Condenseur Titane PVC	HWX80600074	✓	n/a
		HWX80600096	n/a	✓
10	Compresseur	HWX20000110448	✓	n/a
		HWX80100003	n/a	✓
11	/	/	/	/
12	/	/	/	/
13	Bornier L-N-GND -5 connexions 4mm ²	HWX40003901	✓	✓
14	Logo Hayward	HWX20000230596	✓	✓
15	Ecran tactile couleur	HWX95005310612	✓	✓
16	/	/	/	/
17	Grille de protection ventilateur	HWX20000220169	✓	✓
18	Hélice Ventilateur	HWX20000270004	✓	✓
19	Moteur ventilateur DC	HWX20000330132	✓	✓
20	Panneau décoratif gauche	HWX80900088	✓	✓
21	Panneau Avant	HWX80900087	✓	✓
22	Support Moteur	HWX80700248	✓	✓
23	Evaporateur à ailette	HWX80600044	✓	n/a
		HWX80600100	n/a	✓
24	Panneau Gauche	HWX80700455	✓	✓
25	/	/	/	/
26	Panneau supérieur	HWX301090200806	✓	✓
27	Carte électronique Driver	HWX82300008	✓	n/a
		HWX82300007	n/a	✓
28	Transformateur 230V~/12DC	HWX82600008	✓	✓
29	/	/	/	/
30	Relais K2	HWX20000360297	✓	✓
31	Bobine 20A 50Hz 5mH	HWX82500005	✓	✓
32	Pressostat basse pression NO 0.30MPa/0.15MPa	HWX20000360157	✓	✓
33	Prise de pression 40mm-1/2"	HWX20000140150	✓	✓
34	Pressostat haute pression NC 3.2MPa/4.4MPa	HWX20013605	✓	✓
35	Connecteur T ø6.5-2 x ø6.5(T) x 0.75T2M	HWX20001460	✓	✓
36	/	/	/	/
37	Capteur de pression	HWX20000360123	✓	✓
38	Sonde Refoulement Compresseur 50kΩ-660mm	HWX83000026	✓	✓
39	Sonde Température Air 5k-350mm	HWX83000049	✓	✓
	Sonde Sortie d'eau 5k-410mm	HWX83000050	✓	✓
	Sonde Entrée d'eau 5k-850mm	HWX83000052	✓	✓
	Sonde d'Aspiration compresseur 5k-560mm	HWX83000044	✓	✓
	Sonde de dégivrage 5k-680mm	HWX83000051	✓	✓
40	Filtre CEM	HWX20003257	n/a	✓

6. ANNEXES (suite)

6.4 Guide de dépannage



Certaines opérations doivent être réalisées par un technicien habilité.

En cas de défaut sur la pompe à chaleur, le symbole  apparaît en rouge clignotant dans le coin gauche de l'écran.

Appuyer sur le symbole  pour accéder à la liste des erreurs.

Pour plus de détail, consulter le tableau ci-après.

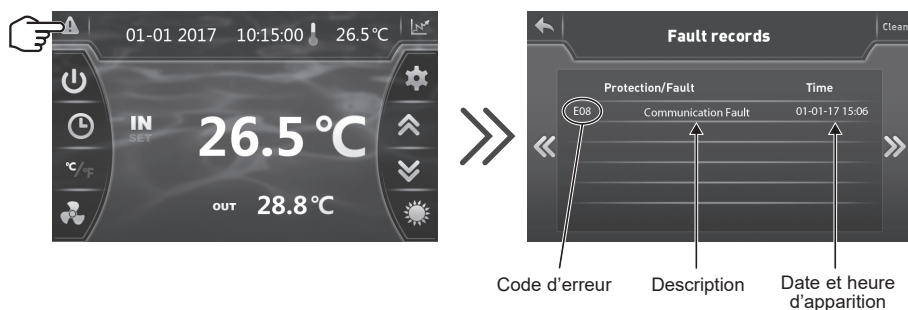

The diagram illustrates the process of accessing fault records. On the left, a hand icon points to a warning triangle in the top-left corner of the main control interface. The interface displays the date (01-01 2017), time (10:15:00), and indoor temperature (26.5 °C). On the right, the 'Fault records' screen is shown, featuring a table with the following data:

Protection/Fault	Time
E08 Communication Fault	01-01-17 15:06

Arrows indicate the mapping between the table headers and labels below: 'Code d'erreur' points to 'E08', 'Description' points to 'Communication Fault', and 'Date et heure d'apparition' points to '01-01-17 15:06'. A 'Clean' button is visible in the top right of the fault records screen.



Après résolution du problème l'erreur est acquitée automatiquement, le triangle passe en grisé fixe.



*Pour effacer la liste d'erreur, appuyer sur **Clean** puis revenir à l'écran précédent en appuyant sur .*

6. ANNEXES (suite)

Dysfonctionnement	Codes d'erreur	Description	Solution
Défaut sonde entrée d'eau	P01	Le capteur est ouvert ou en court circuit	Vérifier la connectique CN21/RES1 sur la carte et le connecteur rallonge ou remplacer le capteur
Défaut sonde de sortie d'eau	P02		Vérifier la connectique N22/RES2 sur la carte et le connecteur rallonge ou remplacer le capteur
Défaut sonde température extérieure	P04		Vérifier la connectique CN12/PH sur la carte et le connecteur rallonge ou remplacer le capteur
Défaut sonde dégivrage	P05		Vérifier la connectique CN8/OPT sur la carte et le connecteur rallonge ou remplacer le capteur
Défaut sonde d'aspiration Compresseur	P07		Vérifier la connectique CN7/OAT sur la carte et le connecteur rallonge ou remplacer le capteur
Défaut sonde de refolement Compresseur	P081		Vérifier la connectique CN9/OHT sur la carte et le connecteur rallonge ou remplacer le capteur
Défaut Haute pression	E01	Le capteur est ouvert ou en court circuit	<p>Vérifier la connectique CN30/HP sur la carte ou remplacer le capteur</p> <p>Vérifier le débit d'eau</p> <p>Vérifier le détecteur de débit d'eau</p> <p>Vérifier l'ouverture des vannes</p> <p>Vérifier le by-pass</p> <p>Vérifier l'encrassement de l'évaporateur</p> <p>Température d'eau trop chaude</p> <p>Problème d'incondensable après une maintenance, vider et tirer au vide le circuit frigorifique</p> <p>Charge de fluide trop importante, retirer du fluide dans une bouteille de liquide</p>
Défaut basse pression	E02	Le capteur est ouvert ou en court circuit	<p>Vérifier la connectique CN31/LP sur la carte ou remplacer le capteur</p> <p>Fuite importante de fluide frigorigène, faire une recherche de fuite au détecteur</p> <p>Débit d'air trop faible, vérifier la vitesse de rotation du ventilateur</p> <p>Vérifier l'encrassement de l'évaporateur, nettoyer sa surface</p>
Défaut détecteur de débit	E03	Le capteur est ouvert ou en court circuit	<p>Vérifier la connectique CN29/OVT sur la carte ou remplacer le capteur</p> <p>Manque d'eau, vérifier le fonctionnement de la pompe de filtration</p> <p>Vérifier l'ouverture des vannes d'arrêts</p> <p>Vérifier le réglage du by-pass</p>

6. ANNEXES (suite)

Dysfonctionnement	Codes d'erreur	Description	Solution
Différence de température Entrée/Sortie > 13°C	E06	Applicable en mode Froid seulement	Manque d'eau, vérifier le fonctionnement de la pompe de filtration
			Vérifier l'ouverture des vannes d'arrêts
			Vérifier le réglage du by-pass
Protection Anti-gel	E07	Température de sortie d'eau < à 4°C	Stopper la pompe à chaleur, vidanger le condenseur risque de gel
Problème de communication	E08	Pas de communication entre la carte électronique et l'interface utilisateur	Vérifier les raccordements et la connectique - voir schéma électrique
Protection Anti-gel de niveau 1	E19	2° < Température d'eau < 4° et Température d'air < 0°	Arrêter le fonctionnement de la pompe à chaleur, vidanger le condenseur pour éviter le gel, par défaut la pompe à chaleur démarre la pompe de filtration pour éviter la prise en glace
Protection Anti-gel de niveau 2	E29	Températures d'eau < à 2° et Température d'air < 0°	Arrêter le fonctionnement de la pompe à chaleur, vidanger le condenseur pour éviter le gel, par défaut la pompe à chaleur démarre la pompe de filtration et la pompe à chaleur pour éviter la prise en glace.
Défaut moteur ventilateur	F031	Moteur bloqué ou défaut de connexion	Vérifier la libre rotation; vérifier la connectique CN97/DCFan; remplacer le moteur
Défaut moteur ventilateur	F051	Défaut de connexion	Vérifier la connectique DCFAN/CN97 ; remplacer le moteur
Température extérieure trop basse	TP	Limite de fonctionnement atteinte	Arrêter la pompe à chaleur
Défaut capteur de pression	PP	Le capteur est ouvert ou en court circuit	Vérifier la connectique voir schéma électrique

6. ANNEXES (suite)

6.5 Base d'enregistrement

A partir de l'écran principal, appuyer sur  pour accéder à l'historique des enregistrements de températures d'entrées et sorties d'eau.



Ces données sont disponibles 60 jours.

Appuyer sur  pour accéder à la puissance électrique moyenne consommée.

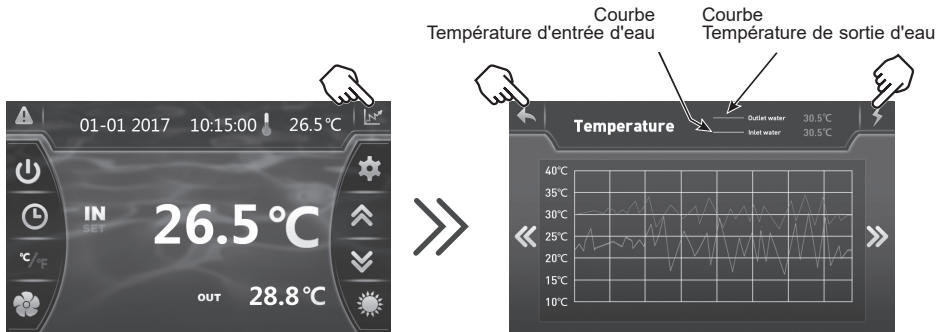

Appuyer sur  pour revenir à l'écran principal.

6. ANNEXES (suite)

6.6 Garantie

CONDITIONS DE GARANTIE

Tous les produits HAYWARD sont garantis contre tous vices de fabrication ou de matière pendant une période de deux années à compter de la date d'achat. Toute demande de garantie devra être accompagnée d'une preuve d'achat justifiant sa date. Nous vous incitons donc à conserver votre facture.

La garantie HAYWARD est limitée à la réparation ou au remplacement, au choix d'HAYWARD, des produits défectueux pour autant qu'ils aient subi un emploi normal, en accord avec les prescriptions mentionnées dans leur manuel d'utilisation, que le produit n'ait été modifié d'aucune sorte et utilisé uniquement avec des composants et des pièces HAYWARD. Les dommages dûs au gel et aux attaques d'agents chimiques ne sont pas garantis.

Tous les autres frais (transport, main d'œuvre...) sont exclus de la garantie.

HAYWARD ne pourra être tenu pour responsable d'aucun dommage direct ou indirect provenant de l'installation, du raccordement ou du fonctionnement incorrect d'un produit.

Pour faire jouer une garantie et demander la réparation ou le remplacement d'un article, adressez vous à votre revendeur. Aucun retour de matériel à notre usine ne sera accepté sans notre accord écrit préalable.

Les pièces d'usure ne sont pas couvertes par la garantie.

ISENPINVR32

ENERGYLINE PRO INVERTER

SWIMMING POOL HEAT PUMP UNIT



Installation & Instruction Manual

CONTENTS

1. PREFACE	1
2. SPECIFICATIONS	4
2.1 Technical data for the swimming pool heat pump unit	4
2.2 Operating range	5
2.3 Dimensions	6
3. INSTALLATION AND CONNECTION	7
3.1 Functional Diagram	7
3.2 Heat pump unit	7
3.3 Hydraulic connection	8
3.4 Electrical connection	9
3.5 Initial start-up	10
3.6 Water flow setting	12
4. USER INTERFACE	13
4.1 General presentation	13
4.2 Setting the Date and Time	14
4.3 Timer function settings	14
4.4 Setting and visualisation of the set point	16
4.5 Locking and unlocking the touch screen	17
4.6 SILENT function settings	18
5. MAINTENANCE AND WINTERISING	21
5.1 Maintenance	21
5.2 Winterising	21
6. APPENDIX	22
6.1 Electrical diagrams	22
6.2 Heating priority wiring for monophasic pump	24
6.3 Exploded view and spare parts	26
6.4 Troubleshooting guide	28
6.5 Recording base	31
6.6 Warranty	32

Please read attentively and save for future consultation.

This document must be given to the pool owner and should be kept in a safe place.

1. PREFACE

Thank you for purchasing the Hayward heat pump for swimming pools. The Hayward FULL INVERTER heat pump has been designed to strict manufacturing standards meeting the highest levels of quality required.

Hayward heat pumps offer you exceptional performance throughout your bathing season by adapting wattage, power usage and noise levels to the heating requirements of your swimming pool thanks to FULL INVERTER control logic.



Read the instructions in this manual carefully before using the device.

Hayward heat pumps are designed exclusively to heat swimming pool water; do not use this equipment for any other purpose.

This manual includes all the necessary information for installation, trouble-shooting and maintenance.

Read this manual carefully before opening the unit or doing any maintenance work on it. The manufacturer of this product shall on no account accept any liability for injury to a user or damage to the unit further to any errors made during installation, trouble-shooting or unnecessary maintenance. It is particularly important to follow the instructions given in this manual at all times.

Otherwise the guarantee will be voided.

1. PREFACE (continued)



Safety instructions



This device contains R32.

Never use a refrigerant other than R32. Any other gaseous body mixed with R32 could cause abnormally high pressure and lead to a failure or pipes bursting and injuring people.

When carrying out repairs or maintenance work, never use copper tubes less than 0.8 mm thick.

As the heat pump is pressurized, never pierce the pipes or attempt any brazing. There is a risk of explosion.

Never expose the device to flames, sparks or other sources of ignition. It could explode and cause serious or even fatal injuries.

- If kept in storage, the heat pump should be kept in a well-ventilated room with a floor area of more than A_{\min} (m²) as calculated by the following formula:
$$A_{\min} = (M / (2.5 \times 0.22759 \times h_0))^2$$

M is the quantity of refrigerant in the device in kg, and h₀ is the storage height. If stored on the floor, h₀ = 0.6 m.
- The heat pump is designed exclusively for installation outside buildings.
- The unit must be installed by qualified personnel.
- Do not install the heat pump on a support that risks intensifying the unit's vibrations.
- Make sure the support provided for the unit is strong enough to bear the weight of the unit.
- Do not install the heat pump anywhere liable to amplify its noise level or anywhere where its noise could disturb neighbours.
- All the electrical connections must be fitted by a professional qualified electrician in accordance with the standards in force in the country of installation, see §3.4.
- Shut off the main power supply and disconnecting switch before doing any electrical work. Forgetting to do so could cause electrocution.
- Before installing the unit, check that the earth cable is not cut or disconnected.

1. PREFACE (continued)

- Connect and properly tighten the power cable. A loose connection could damage electrical components.
- Exposing the heat pump to water or a humid atmosphere could cause electrocution. Be very careful.
- If you detect a fault or any abnormal situation, do not install the heat pump and contact your dealer immediately.
- All maintenance work should be done at the recommended intervals, as specified in this manual.
- Repairs must be carried out by qualified personnel.
- Only use OEM spare parts.
- Never use a cleaning method other than the one recommended in this manual.

Important information concerning the refrigerant used

This makes contains fluorinated greenhouse gases regulated by the Kyoto protocol. Do not release these gases into the atmosphere.

Type of refrigerant: R32

GWP(1) value: 675, based in the 4th report of the IPCC.

The quantity of refrigerant, based on the F-Gas regulation no. 517/2014, is stated on the unit's rating plate.

Period checks for leaks of refrigerant may be required by European or local legislation. Please contact your local dealer for more information.

(1) Global warming potential

2. SPECIFICATIONS

2.1 Technical data for the swimming pool heat pump unit

Models	ENERGYLINE PRO INVERTER	ENPI4M	ENPI6M
Supply voltage	V	220V-240V ~ / 1ph / 50Hz	
Refrigerant	/	R32	
Load	kg	0,50	0,65
Mass in teqCO ₂	/	0,34	0,44
Leak check frequency	/	No specific frequency, but an annual check is recommended	
Min--Max heating capacity ^(a)	kW	2,50--9,73	3,20--11,9
Min--Max electric input power ^(a)	kW	0,20--1,34	0,28--1,68
Min--Max continuous current rating ^(a)	A	1,33--6,02	1,34--7,32
Max--Min continuous power (COP) (a)	/	12,32--7,12	11,51--7,10
Min--Max heating capacity ^(b)	kW	1,71--7,60	2,70--9,70
Min--Max electric input power ^(b)	kW	0,27--1,49	0,44--1,88
Max--Min continuous power (COP) ^(b)	/	6,40--5,1	6,10--5,55
Maximum continuous current	A	7,30	8,90
Fuse rating	aM	8	10
Circuit-breaker curve D	D	8	10
Starting current	A	< CMS	< CMS
Hydraulic connection	mm	50mm	
Nominal water flow (a)	m ³ /h	4,20	5,10
Max. loss of head on water	kPa	3,3	4,5
Compressor	/	DC Inverter Mitsubishi	DC Inverter Highly
Type	/	Twin rotary	Twin rotary
Quantity	/	1	
Coil resistance at 20°C	Ohm	1,91	0,788
Fan	/	Axial	
Quantity	/	1	
Diameter	mm	405	510
Number of blades	/	3	
Motor	/	DC Inverter	
Quantity	/	1	1
Rotation speed	rpm	500--700	500-650
Silent mode speed	rpm	300	400
Sound pressure level at 1 metre	dB(A)	33--41	33-41
Sound pressure level at 10 metres	dB(A)	16--25	16--25
Unit's net dimensions (L-W-H)	mm	1046/400/768	
Weight	kg	53	65



(a) Dry air 27°C - Relative humidity 78% - Water inlet temperature 26°C.

(b) Dry air 15°C - Relative humidity 71% - Water inlet temperature 26°C

2. SPECIFICATIONS (continued)

2.2 Operating range

Use the swimming pool heat pump unit within the following ranges of temperature and humidity to ensure safe and efficient operation.

	Heating mode 	Cooling mode 
Outside temperature	-12°C – +35°C	+7°C – +43°C
Water temperature	+12°C – +40°C	+8°C – +40°C
Relative humidity	< 80%	< 80%
Setting range from the set point	+15°C – +32°C	+8°C – +32°C



If the temperature or humidity does not correspond to these conditions, the security measures could be activated and the swimming pool heat pump unit may no longer work.



The maximum heating temperature is set at 32°C to prevent damage to the liners. Hayward cannot be held responsible if used at a temperature above +32°C.

2. SPECIFICATIONS (continued)

2.3 Dimensions

Models:

ENPI4M / ENPI6M

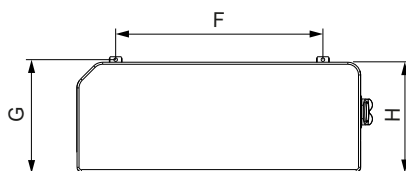
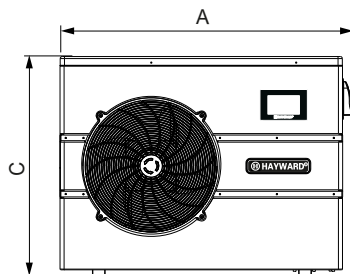
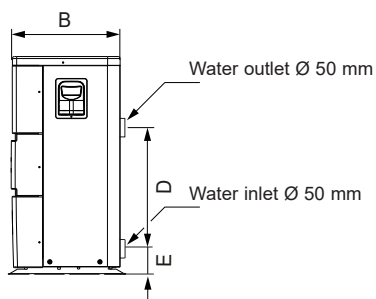

Unit: mm

SIZE \ TYPE	ENPI4M / ENPI6M
A	1046
B	400
C	768
D	350
E	110
F	615
G	428
H	400

3. INSTALLATION AND CONNECTION

3.1 Functional Diagram

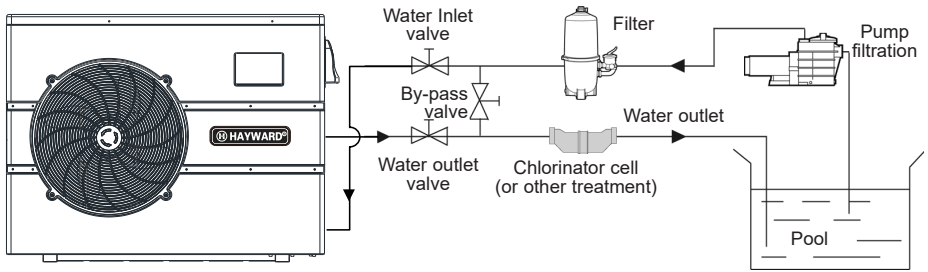

Note : The swimming pool heat pump unit is sold without any treatment or filtration equipment. The components presented in the diagram are spare parts to be supplied by the installer.

3.2 Heat pump unit



Place the heat pump outdoors and away from any enclosed technical space.

Placed under a shelter, the minimum required distances mentioned below must be respected in order to avoid any risk of air recirculation and a deficiency in the unit's overall performance.

Unit: mm

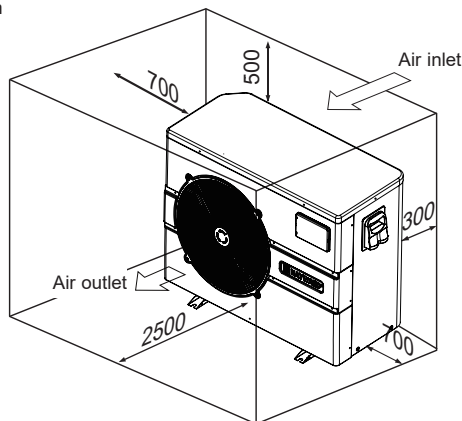

3. INSTALLATION AND CONNECTION (continued)



It is advised to install the unit on a dissociated cement block or a mounting bracket designed for this use and to set up the unit on the supplied rubber bushing (fastenings and washers not supplied).

The maximum installation distance between the unit and the swimming pool is 15 metres.

The total length of the piping to and from the unit is 30 metres.

Insulate both the above ground and buried hydraulic piping.

The heat pump must be installed at a minimum distance from the pool in compliance with NF C 15-100 (3.5 m from the water for France) or in compliance with installation standards applicable in other countries.

Do not install the heat pump close to a heat source.

For installation in snowy regions we recommend sheltering the machine to avoid snow accumulating on the evaporator.

3.3 Hydraulic connection

The unit is supplied with two 50 mm Ø union connections. Connect the water inlet to the heat pump coming from the filtration group then connect the water outlet to the heat pump at the water conduit going to the pool (see diagram below).

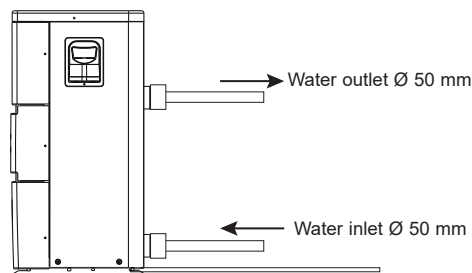

Install a by-pass valve between the heat pump entrance and exit.



If an automatic distributor or an electrolyser is used, it should be installed imperatively after the heat pump with the goal of protecting the titanium condenser against an elevated concentration of chemicals.



Be sure to install the by-pass valve and the supplied union connections at the water inlet and outlet level in order to simplify purging during the winter period and to facilitate access when disassembling for maintenance.

3. INSTALLATION AND CONNECTION (continued)

3.4 Electrical connection



Electrical installation and wiring for this equipment must be in conformity with local installation standards.

F	NF C15-100	GB	BS7671:1992
D	DIN VDE 0100-702	EW	EVHS-HD 384-7-702
A	ÖVE 8001-4-702	H	MSZ 2364-702/1994/MSZ 10-553 1/1990
E	UNE 20460-7-702 1993, RECBT ITC-BT-31 2002	M	MSA HD 384-7-702.S2
IRL	Wiring Rules + IS HD 384-7-702	PL	PN-IEC 60364-7-702:1999
I	CEI 64-8/7	CZ	CSN 33 2000 7-702
LUX	384-7.702 S2	SK	STN 33 2000-7-702
NL	NEN 1010-7-702	SLO	SIST HD 384-7-702.S2
P	RSIUEE	TR	TS IEC 60364-7-702



Verify that the available electrical power supply and the network frequency correspond to the required operating current taking into account the appliance's specific location, and the current required to supply any other appliance connected to the same circuit.

ENPI4M 230V \sim +/- 10 % 50 Hz 1 Phase

ENPI6M 230V \sim +/- 10 % 50 Hz 1 Phase

See the corresponding wiring diagram in the appendix.

The connection box is located on the right side of the unit. Three connections are designed for the power supply and two are for controlling the filter pump (Enslavement).

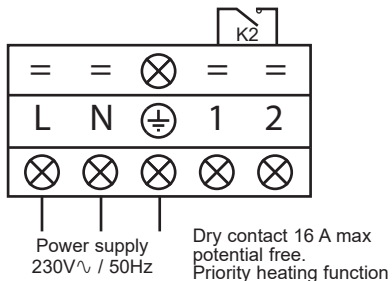

3. INSTALLATION AND CONNECTION (continued)



The electrical power supply must have, when appropriate, a fuse protection device like a feed motor (aM) or D curve circuit breaker as well as a differential circuit breaker 30mA (see following table).

Models		ENPI4M	ENPI6M
Power supply	V/Ph/Hz	230V~/ 50Hz	230V~/ 50Hz
aM type fuse calibre	A	8 aM	10 aM
Curve D circuit breaker	A	8 D	10 D
Cable section	mm ²	3G 2,5	3G 2,5



Use an RO 2V/R 2V or equivalent power cord.





The cables sections are given for a maximum length of 25 m. They must however be checked and adjusted according to the installation conditions.



Always shut down the main power supply before opening the electrical control box.

3.5 Initial start-up

Start-up procedure - After installation is complete, follow these steps:

- 1) Rotate the fans by hand to verify that they can turn freely by hand, and that the turbine is correctly affixed to the motor shaft.
- 2) Ensure that the unit is connected correctly to the main power supply (see the wiring diagram in the appendix).
- 3) Activate the filtration pump.
- 4) Verify that all water valves are open and that the water flows toward the unit before switching on the heating or cooling mode.
- 5) Verify that the drainage hose is correctly affixed and that it causes no obstructions.
- 6) Activate the unit power supply, then press the On/Off button  on the control panel.
- 7) Ensure that the alarm signal () does not light up red.
If necessary see the troubleshooting guide (see § 6.4).

3. INSTALLATION AND CONNECTION (continued)

- 8) Set the water flow using the by-pass valve (see § 3.6 and 2.1), as provided for by each model, to obtain an Entry/Exit temperature of 2°C.
- 9) After running for several minutes, verify that the air exiting the unit is cool (between 5 and 10°).
- 10) With the unit operating, turn off the filter pump. The unit should automatically turn off and display error code E03 (See § 6.4).
- 11) Allow the unit and the pool pump to run 24 hours per day until the desired water temperature has been reached. When the set water inlet temperature is reached, the unit will turn off. It will automatically restart (as long as the pool pump is running) if the pool temperature is at least 0.5°C below the set temperature.

Water flow switch - The unit is equipped with a flow switch that turns on the heat pump when the pool filtration pump is running, and deactivates it when the filtration pump is out of order. If the water is low, the E03 alarm code will appear on the regulator (See § 6.4).

Time delay - The unit is equipped with a time delay of 3 minutes in order to protect the control circuit components, to eliminate restart cycling and contactor chatter. Thanks to this time delay, the unit automatically restarts approximately 3 minutes after each control circuit interruption. Even a brief power interruption will activate the restart time delay.

3. INSTALLATION AND CONNECTION (continued)

3.6 Water flow setting

With the water entry and exit valves being open, adjust the by-pass valve in order to obtain a difference of 2°C between the inflow and outflow temperature (see principle diagram § 3.1). You can verify the switch by seeing the entry/ exit temperatures directly on the control panel.

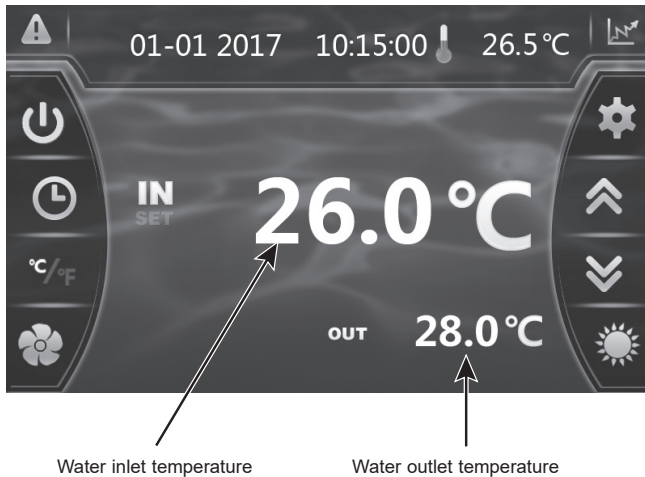

Note: Opening the by-pass valve creates a weaker flow, which leads to an increase in ΔT .

Closing the by-pass valve creates a stronger flow, which leads to a decrease in ΔT .

4. USER INTERFACE

4.1 General presentation

The heat pump is equipped with a digital control panel with a touch screen, electronically connected and pre-set at the factory in heating mode.

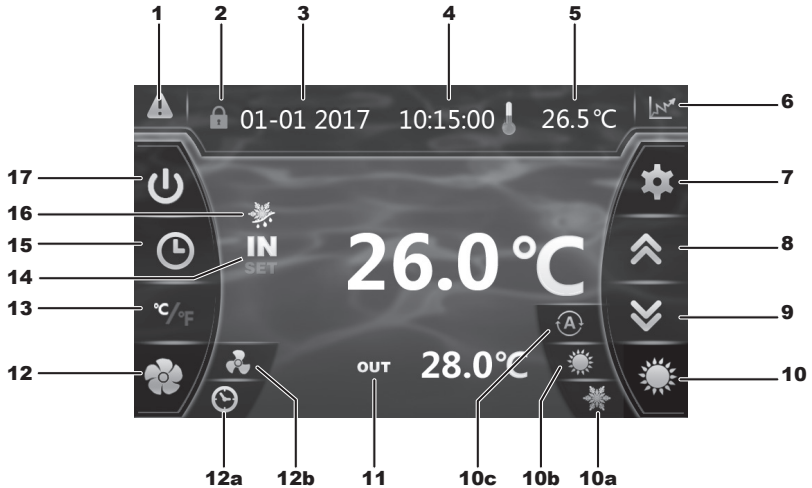

Legend

1		Alarm (blinking red)
2		Locked screen
3		Date
4		Hour
5		Outside temperature
6		Recording base (Water temperature and power consumption)
7		Reading settings and saving
8		Scroll up / Increase
9		Scroll down / Decrease
10		Operating mode selection
10a		Cooling mode

10b		Heating mode
10c		Automatic mode
11		Water Output temperature
12		Selecting silence mode
12a		Setting silence mode timer
12b		Silence mode and activation light
13		Conversion °C / °F
14		Water Input temperature
15		Setting the Timer date and time ON/OFF
16		Defrost mode
17		On / Off

4. USER INTERFACE (continued)

OFF Mode

When the heating pump is in sleep mode (OFF Mode), the button  is grey.

ON Mode

When the heating pump is running or regulating (ON Mode), the button  lights up green.

4.2 Setting the Date and Time

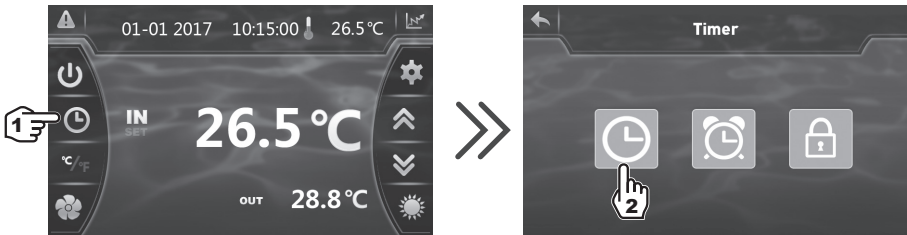

Enter all the fields (Day/Month/Year, Hour/Minute/Second) before confirming, otherwise the changes will not be saved.

4.3 Timer function settings

Setting this function is necessary if you would like to run the heat pump for a shorter period than what is defined by the filtration clock. Therefore, you can program a deferred start and an anticipated stop or simply stop a certain timeframe from running (at night, for example).

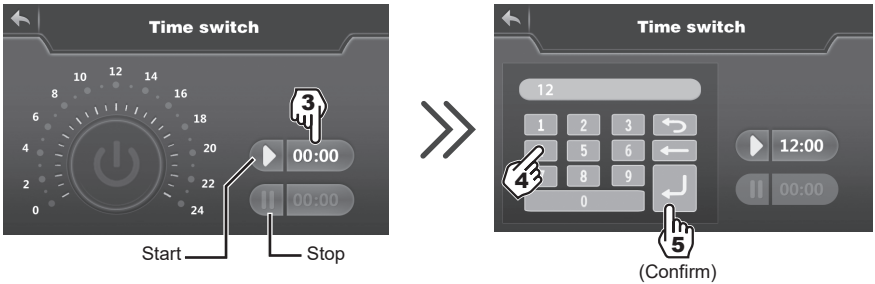
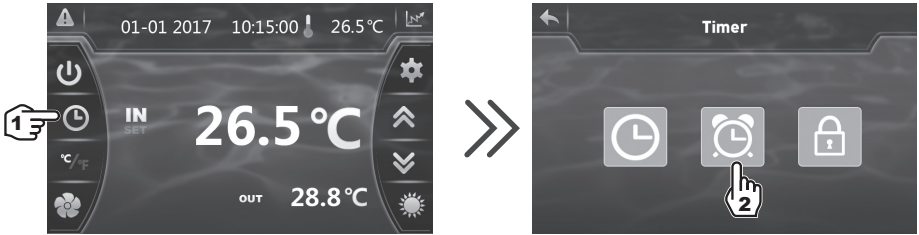

It is possible to set one Start Timer and one Stop Timers.

4. USER INTERFACE (continued)



 Blue highlighting = Activated
 Grey = Deactivated

 **The setting step is "hour to hour".**



- Once the start time has been set, press  (step 6) to activate the Timer. The symbol and time now have blue highlighting.
- Repeat steps 3 to 6 to set and activate the stop time ( 00:00)
- When the settings are complete, the operating range of the heat pump is highlighted in green and the highlight range is yellow.
- Press twice on  to return to the main screen.

4. USER INTERFACE (continued)

4.4 Setting and visualisation of the set point



In Mode “OFF” or Mode “ON”

Press the button  to display the set point, then press  or  to set the set point you wish.

Confirm by pressing  and you will return to the main screen automatically.



The setting is made with a precision of 0.5 °C.





It is recommended to never exceed 30°C to avoid alteration of the liners.

4. USER INTERFACE (continued)

4.5 Locking and unlocking the touch screen

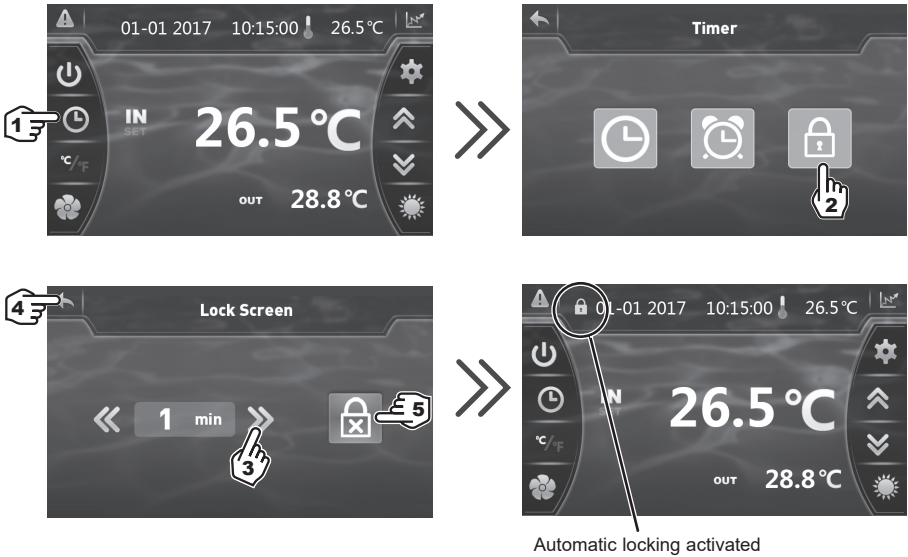
The control screen locks automatically after one minute (default setting). It is possible to adjust the time before the screen locks automatically to between 1 and 10 minutes, or simply to cancel this function.



- 3) Set the time to between 1 and 10 minutes. Saving is automatic.
- 4) Press  twice to return to the main screen.
- 5) To deactivate automatic locking press .

To unlock the screen, press (anywhere) on the screen for 2s.
Enter the code "22" and confirm by pressing 



4. USER INTERFACE (continued)

4.6 SILENT function settings

Silence mode enables the heat pump to be used in economic and very silent mode when the heating needs are low (maintaining the pool temperature or need for ultra-silent operation).

This function can be Activated/Deactivated manually or using a Timer.

Manual Activation

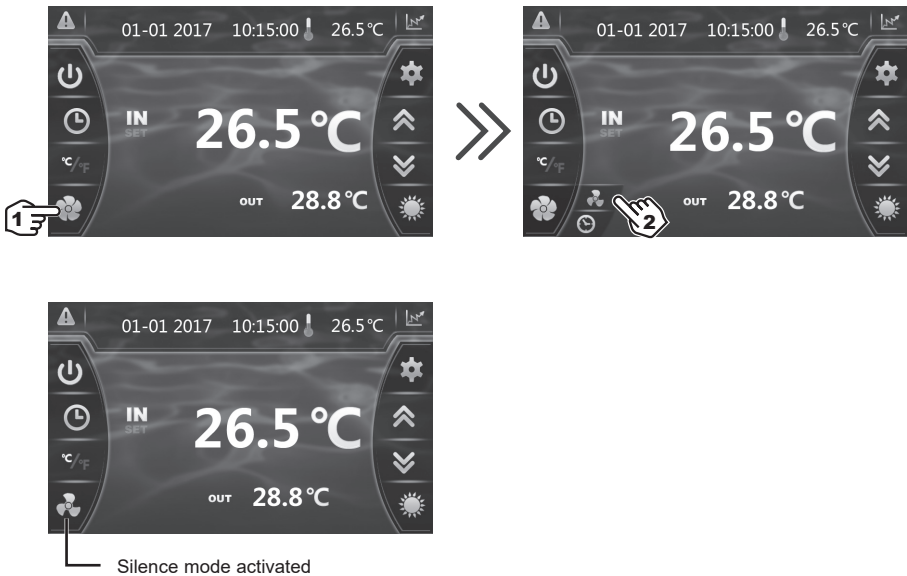

4. USER INTERFACE (continued)

Manual Deactivation

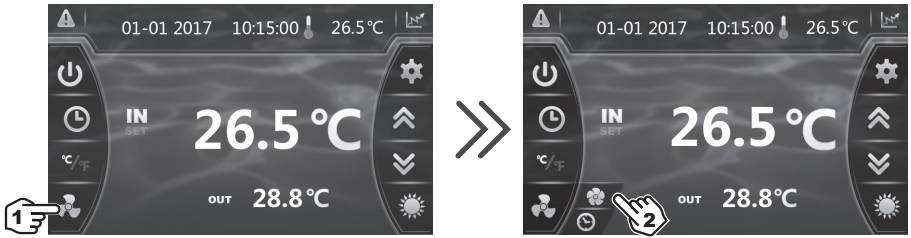

Silence mode deactivated

Setting the Timer

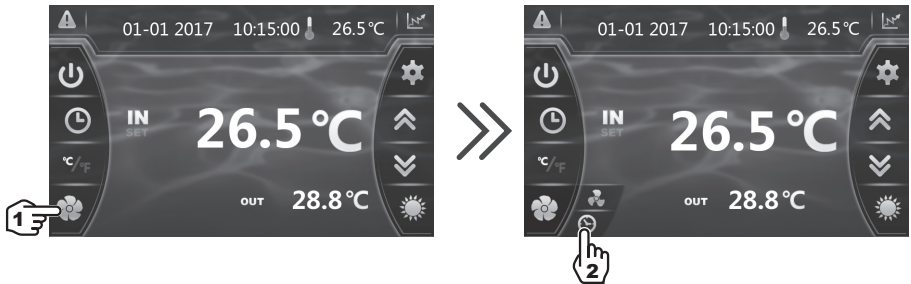

4. USER INTERFACE (continued)

Setting the Timer (continued)

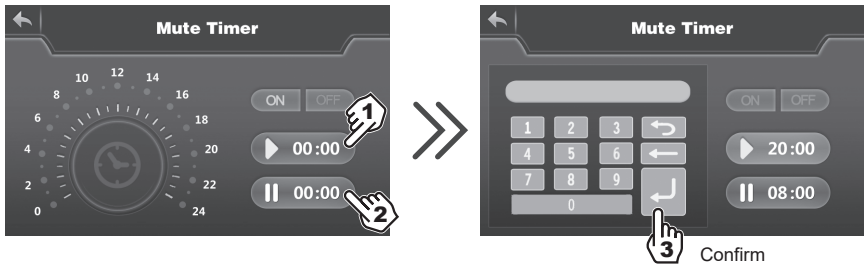

- 1) Start time, input and confirmation.
- 2) End time, input and confirmation.
- 3) Confirm.

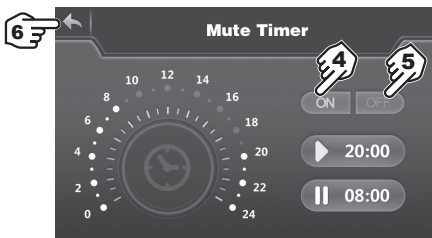

- 4) Activation.
- 5) Deactivation.
- 6) Back to the main screen.



***The setting step is "hour to hour".
Once the Timer is activated, it is active 7 days a week.***

5. MAINTENANCE AND WINTERISING

5.1 Maintenance

These maintenance operations must be carried out once per year in order to guarantee the longevity and the good working condition of the heat pump.

- Clean the coil with the help of a soft brush or jet of air or water (**Warning, never use a high pressure cleaner**).
- Verify that the drains flow well.
- Verify the tightening of the hydraulic and electrical connections
- Verify the hydraulic sealing of the condenser.
- Have the leak-tightness of the cooling circuit to the leak detector checked by an **accredited professional**.



Before any maintenance operation, the heating pump must be disconnected from any electrical current source. The maintenance operations must only be carried out by personnel that is qualified and authorised to handle liquid refrigerants.

5.2 Winterising

- Put the heat pump in “OFF” mode.
- Cut the power supply to the heat pump.
- Empty the condenser with the help of the drain to avoid any risk of deterioration. (high risk of freezing).
- Close the by-pass valve and unscrew the entry/exit connection unions.
- Eliminate the maximum amount of residual stagnant water from the condenser with the help of an air gun.
- Close the water entry and exit areas of the heating pump to avoid introducing foreign bodies.
- Cover the heating pump with a dedicated winterising case.



Any damage caused by poor winterising maintenance will lead to cancellation of the warranty.

6. APPENDIX

6.1 Electrical diagrams

ENPI4M

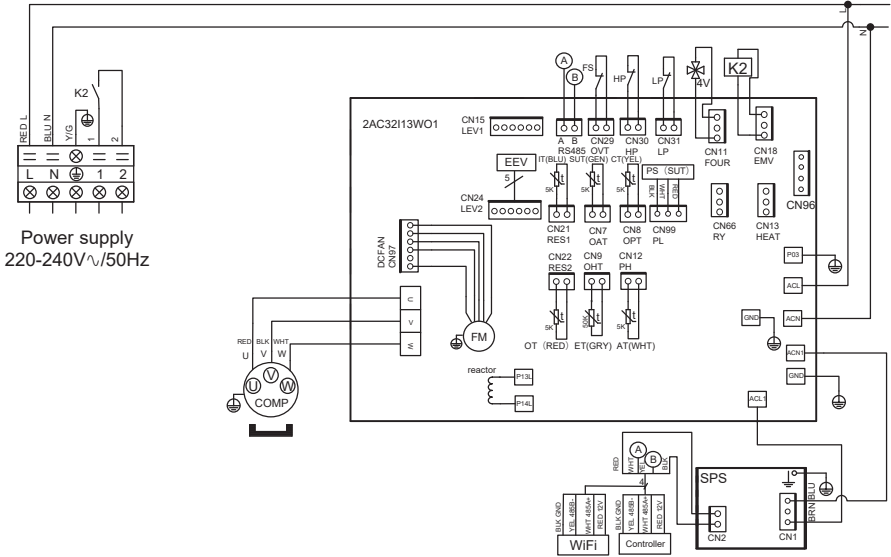

REMARKS:

- AT : AIR TEMPERATURE SENSOR
- COMP : COMPRESSOR
- CT : EVAPORATOR TEMPERATURE SENSOR
- EEV : ELECTRONIC EXPANSION VALVE
- FM : FAN MOTOR
- FS : WATER FLOW SWITCH
- HP : HIGH PRESSURE SWITCH
- IT : WATER INLET TEMPERATURE SENSOR

- LP : LOW PRESSURE SWITCH
- OT : OUTLET WATER TEMPERATURE SENSOR
- SUT : SUCTION TEMPERATURE SENSOR
- 4V : 4 WAYS VALVE
- K2 : DRY CONTACT 16 A MAX
- ET : DISCHARGE TEMPERATURE SENSOR
- PS : PRESSURE SENSOR

6. APPENDIX (continued)

ENPI6M

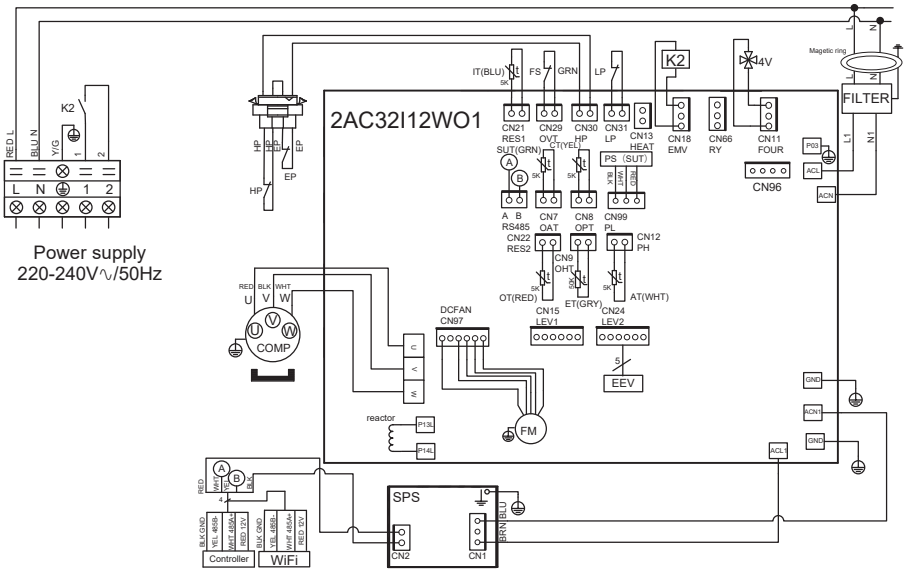

REMARKS:

- | | |
|--|---|
| AT : AIR TEMPERATURE SENSOR | LP : LOW PRESSURE SWITCH |
| COMP : COMPRESSOR | OT : OUTLET WATER TEMPERATURE SENSOR |
| CT : EVAPORATOR TEMPERATURE SENSOR | SUT : SUCTION TEMPERATURE SENSOR |
| EEV : ELECTRONIC EXPANSION VALVE | 4V : 4 WAYS VALVE |
| FM : FAN MOTOR | K2 : DRY CONTACT 16 A MAX |
| FS : WATER FLOW SWITCH | ET : DISCHARGE TEMPERATURE SENSOR |
| HP : HIGH PRESSURE SWITCH | PS : PRESSURE SENSOR |
| IT : WATER INLET TEMPERATURE SENSOR | |

6. APPENDIX (continued)

6.2 Heating priority wiring for monophasic pump

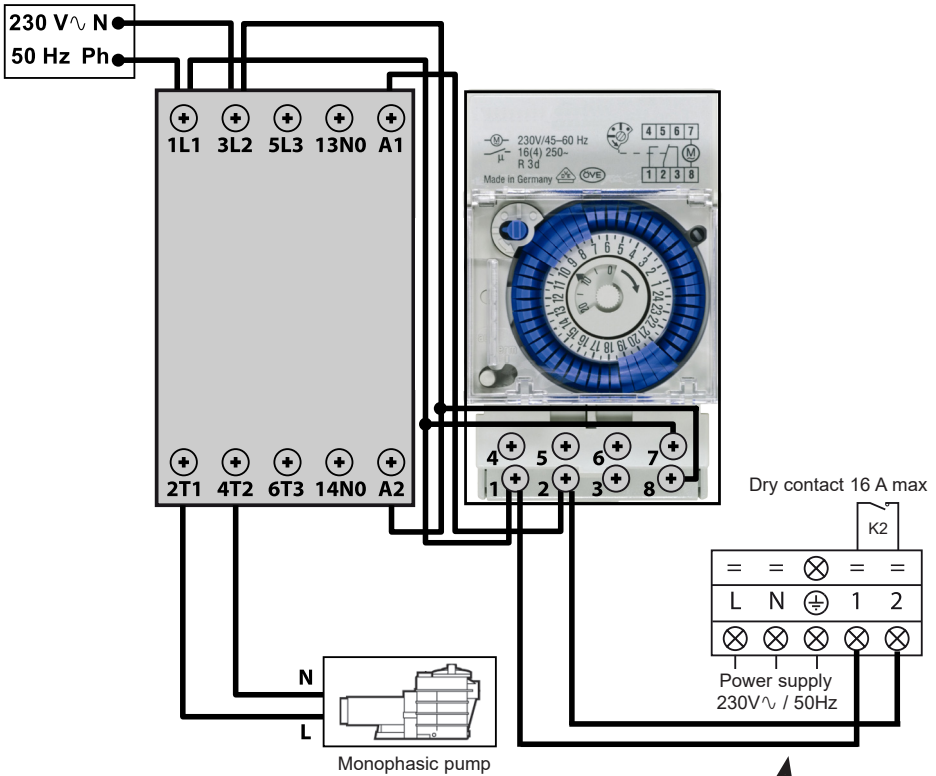

Terminals 1 and 2 deliver a potential-free dry contact, 230V~/ 50 Hz, no polarity.

Wire terminals 1 and 2 as indicated in the diagram above, to activate the operation of the filtration pump in 2-minute cycles each hour if the temperature of the pool is lower than the set point.

! Never connect the power supply of the filtration pump directly to terminals 1 and 2.



Page left intentionally blank

6. APPENDIX (continued)

6.3 Exploded view and spare parts

ENPI4M / ENPI6M

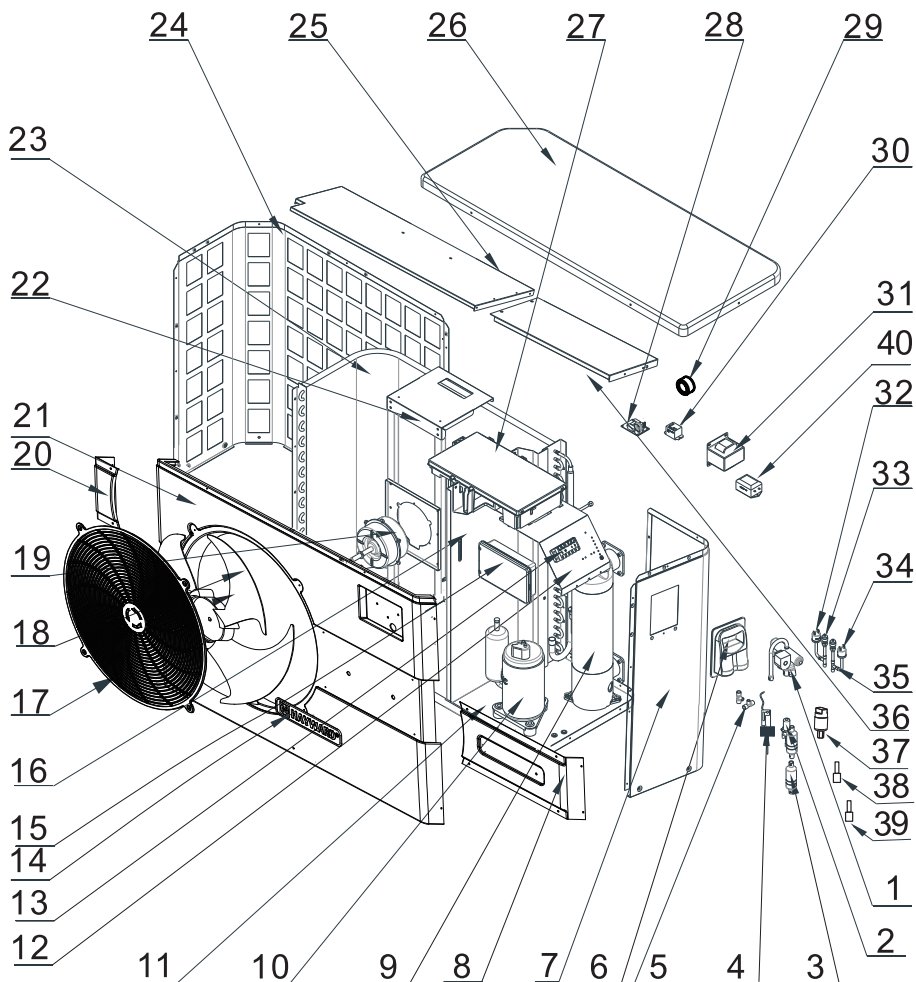

6. APPENDIX (continued)

ENPI4M / ENPI6M

Mark	Description	Ref.	ENPI4M	ENPI6M
1	4 ways valve	HWX20041437	✓	✓
2	Electronic expansion valve	HWX81000015	✓	n/a
		HWX81000016	n/a	✓
3	Filter ø9.7-ø9.7 (Ø28)	HWX20041444	✓	✓
4	Water flow detector	HWX83000012	✓	✓
5	T connector ø9.52-2 x ø6.5(T) x 1.0	HWX304030000002	✓	✓
6	Access hatch	HWX320922029	✓	✓
7	Right panel	HWX80700455	✓	✓
8	Right decorative panel	HWX80900089	✓	✓
9	Titanium/PVC condenser	HWX80600074	✓	n/a
		HWX80600096	n/a	✓
		HWX20000110448	✓	n/a
10	Compressor	HWX80100003	n/a	✓
11	/	/	/	/
12	/	/	/	/
13	Terminal block L-N-GND -5 connections 4mm ²	HWX40003901	✓	✓
14	HAYWARD logo	HWX20000230596	✓	✓
15	Colour touchscreen	HWX95005310612	✓	✓
16	/	/	/	/
17	Fan protection grille	HWX20000220169	✓	✓
18	Fan blade	HWX20000270004	✓	✓
19	DC ventilator motor	HWX20000330132	✓	✓
20	Left decorative panel	HWX80900088	✓	✓
21	Front panel	HWX80900087	✓	✓
22	Motor bracket	HWX80700248	✓	✓
23	Fin coil	HWX80600044	✓	n/a
		HWX80600100	n/a	✓
24	Left panel	HWX80700455	✓	✓
25	/	/	/	/
26	Top cover	HWX301090200806	✓	✓
		HWX82300008	✓	n/a
27	Printed circuit board Driver	HWX82300007	n/a	✓
		HWX82600008	✓	✓
28	230V~/12VDC transformer	HWX82600008	✓	✓
29	/	/	/	/
30	K2 relay	HWX20000360297	✓	✓
31	20A 50Hz 5mH coil	HWX82500005	✓	✓
32	Low pressure switch NO 0.30MPa/0.15MPa	HWX20000360157	✓	✓
33	Pressure Tap 40mm 1/2"	HWX20000140150	✓	✓
34	High pressure switch NC 3.2MPa/4.4MPa	HWX20013605	✓	✓
35	T connector ø6.5-2 x ø6.5(T) x 0.75T2M	HWX20001460	✓	✓
36	/	/	/	/
37	Pressure sensor	HWX20000360123	✓	✓
38	Compressor discharge probe 50 kΩ-660mm	HWX83000026	✓	✓
39	Ambiente temp sensor 5k-350mm	HWX83000049	✓	✓
	Water outlet sensor 5k-410mm	HWX83000050	✓	✓
	Water inlet sensor 5k-850mm	HWX83000052	✓	✓
	Compressor aspiration sensor 5k-560mm	HWX83000044	✓	✓
	De-icing sensor 5k-680mm	HWX83000051	✓	✓
40	EMC filter	HWX20003257	n/a	✓

6. APPENDIX (continued)

6.4 Troubleshooting guide



Certain operations must be carried out by an authorized technician.

If there is a fault on the heat pump, the symbol  appears blinking red in the left hand corner of the screen.

Press the symbol  to access the list of errors.

Refer to following table.

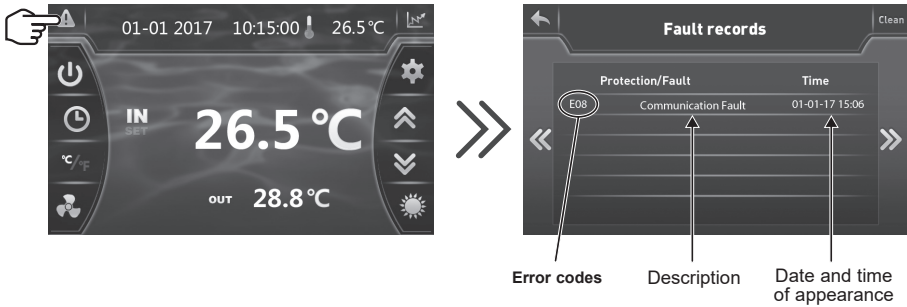

Once the problem has been resolved the error is cancelled automatically and the triangle changes to solid grey.



To delete the error list, press on  then return to the previous screen by pressing on .

6. APPENDIX (continued)

Problem	Error codes	Description	Solution
Water inlet sensor fault	P01	The sensor is open or has short-circuited.	Verify the CN21/RES1 connectors on the board and the extension connector or replace the sensor
Water outlet sensor fault	P02		Verify the N22/RES2 connectors on the board and the extension connector or replace the sensor
Outside temperature sensor fault	P04		Verify the CN12/PH connectors on the board and the extension connector or replace the sensor
De-icing sensor fault	P05		Verify the CN8/OPT connectors on the board and the extension connector or replace the sensor
Compressor aspiration sensor defect	P07		Verify the CN7/OAT connectors on the board and the extension connector or replace the sensor
Compressor discharge sensor fault	P081		Verify the CN9/OHT connectors on the board and the extension connector or replace the sensor
High pressure protection	E01	The sensor is open or has short-circuited.	Verify the CN30/HP connectors on the card or replace the sensor Check the water flow Check the water flow detector Check the valve opening Check the by-pass Check the evaporator is not clogged Water temperature too hot Incondensable problem after maintenance, empty and evacuate the cooling circuit Fluid load too high, remove fluid into a liquid bottle
Low pressure protection	E02	The sensor is open or has short-circuited.	Check the AI/DI03 connections on the card or replace the sensor Large coolant leak, search for the leak with the detector Air flow too low, check the ventilator rotation speed Check the evaporator is not clogged, clean its surface
Flow sensor fault	E03	The sensor is open or has short-circuited.	Check the AI/DI02 connections on the card or replace the sensor Lack of water, check the filtration pump operation Check the stop valve opening Check the by-pass adjustment

6. APPENDIX (continued)

Problem	Error codes	Description	Solution
Input/Output temperature difference > 13°C	E06	Applicable in Cold mode only	Lack of water, check the filtration pump operation
			Check the stop valve opening
			Check the by-pass adjustment
Antifreeze protection Cold mode	E07	Water output temperature < 4°C	Stop the heat pump, empty the condenser risk of freezing
Communication problem	E08	No communication between the printed circuit board and the user interface	Check the connectors - see the wiring diagram
Level 1 antifreeze protection	E19	2° < Water temperature < 4° and Air temperature < 0°	Stop heat pump operation, empty the condenser to avoid freezing, by default the heat pump starts the filtration pump to avoid icing over
Level 2 antifreeze protection	E29	Water temperature < 2° and Air temperature < 0°	Stop heat pump operation, empty the condenser to avoid freezing, by default the heat pump starts the filtration pump and the heat pump to avoid icing over.
Fan motor fault	F031	Motor jammed or faulty connection	Check free rotation; check CN97/DC connectors; replace the motor
Fan motor fault	F051	Faulty connection	Check the DCFAN/CN97 connector; replace the motor
Exterior temperature too low	TP	Operating limit reached	Stop the heat pump
Pressure sensor fault	PP	The sensor is open or short-circuiting	Check the connections see electrical diagram

6. APPENDIX (continued)

6.5 Recording base

From the main screen, press on  to access the history of water input and output temperature recordings.

 ***This data is available for 60 days.***

Press on  to access the average electric power consumed.

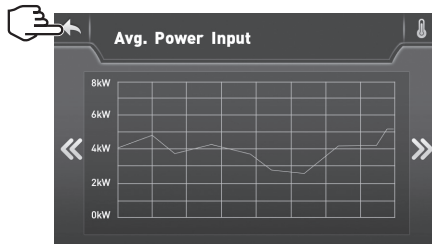
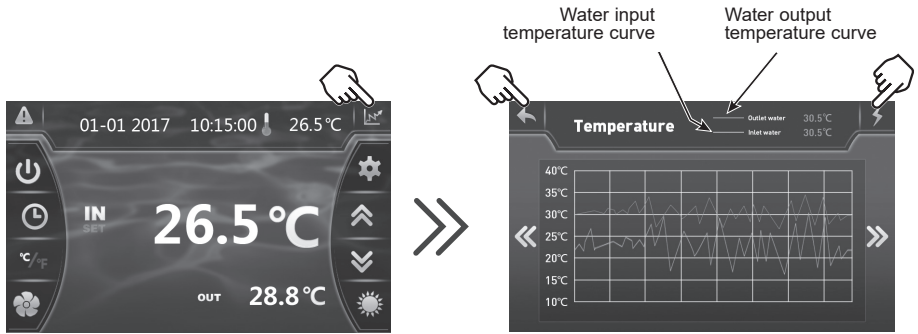

Press on  to return to the main screen.

6. APPENDIX (continued)

6.6 Warranty

WARRANTY CONDITIONS

All HAYWARD products are guaranteed to be free from manufacturing or material faults for a period of two years as from the date of purchase. Any claim made under the terms of the warranty must be accompanied by a dated proof of purchase. We therefore recommend that you keep your invoice.

The HAYWARD warranty is limited to the repair or replacement, at HAYWARD's discretion, of faulty products, provided they have been used under normal conditions, as described in their user guide, and that the product has not been modified in any way and has been used only with HAYWARD components and parts. Frost and chemical damage are not covered.

No other costs (transportation, labour, etc.) are covered by the warranty.

HAYWARD cannot be held liable for any direct or indirect damage caused by the incorrect installation, connection or operation of a product.

Please contact your retailer if you want to make a claim under the terms of the warranty and request the repair or replacement of an item. No equipment returned to our factory will be accepted without our prior written agreement.

Worn parts are not covered by the warranty.

ISENPINVR32

ENERGYLINE PRO INVERTER

UNIDAD DE BOMBA DE CALOR PARA PISCINAS



Manual de Instalación e Instrucciones

ÍNDICE

1. PREFACIO	1
2. CARACTERÍSTICAS TÉCNICAS	4
2.1 Datos técnicos de la bomba de calor	4
2.2 Margen de funcionamiento	5
2.3 Dimensiones	6
3. INSTALACIÓN Y CONEXIÓN	7
3.1 Esquema eléctrico	7
3.2 Bomba de calor	7
3.3 Conexión hidráulica	8
3.4 Conexión eléctrica	9
3.5 Primer arranque	10
3.6 Ajuste del caudal de agua	12
4. INTERFAZ USUARIO	13
4.1 Presentación general	13
4.2 Ajuste de la fecha y de la hora	14
4.3 Ajuste de la función Timer	14
4.4 Ajuste y visualización del punto de referencia	16
4.5 Apertura y bloqueo automático de la pantalla táctil	17
4.6 Ajuste del modo silencioso	18
5. MANTENIMIENTO E INVIERNO	21
5.1 Mantenimiento	21
5.2 Invierno	21
6. ANEXOS	22
6.1 Esquemas eléctricos	22
6.2 Conexiones con prioridad al calentador de bomba monofásico	24
6.3 Despiece y piezas de recambio	26
6.4 Guía de reparación	28
6.5 Base de registro	31
6.6 Garantía	32

Leer atentamente y conservar para consultar con posterioridad.

Este documento debe suministrarse al propietario de la piscina y debe ser conservado por éste en un lugar seguro.

1. PREFACIO

Le agradecemos la compra de esta bomba de calor de piscina Hayward. La bomba de calor Hayward FULL INVERTER ha sido diseñada según normas estrictas de fabricación para satisfacer los más altos niveles de calidad requeridos.

Las bombas de calor Hayward le ofrecerán excepcionales prestaciones a todo lo largo de su temporada de baños, adaptando la potencia, el consumo eléctrico y el nivel sonoro a la necesidad de calentamiento de su piscina gracias a la lógica de control FULL INVERTER.



Lea atentamente las consignas de este manual antes de utilizar el aparato.

Las bombas de calor Hayward están exclusivamente destinadas a calentar el agua de la piscina, no utilizar este material para otros fines.

El presente manual incluye todas las informaciones necesarias referentes a la instalación, la eliminación de los disfuncionamientos y el mantenimiento.

Lea atentamente este manual antes de abrir la unidad o de realizar operaciones de mantenimiento en la misma. En ningún caso, el fabricante del producto será responsable en caso de lesiones de un usuario o de daño de la unidad debido a eventuales errores de instalación, de eliminación de disfuncionamientos o de un mantenimiento inadecuado. Es primordial seguir en todo momento las instrucciones especificadas en este manual.

El no respeto de cualquier recomendación anula la garantía.

1. PREFACIO (continuación)

	<h2>Consignas de seguridad</h2>
---	---------------------------------

	<p><i>Este aparato contiene R32.</i></p> <p><i>Nunca utilizar otro refrigerante que no sea el R32. Cualquier otro cuerpo gaseoso mezclado con el R32 corre el riesgo de provocar presiones anormalmente elevadas que pueden ocasionar una avería o una ruptura de tubos y lesionar personas.</i></p> <p><i>En las reparaciones u operaciones de mantenimiento, nunca utilizar tubos de cobre de un espesor inferior a 0,8 mm.</i></p> <p><i>Como la bomba de calor está a presión, nunca perforar los tubos ni intentar hacer una soldadura. Hay riesgo de explosión.</i></p> <p><i>Nunca exponer el aparato a llamas, chispas ni otras fuentes de encendido. Podría explosionar y ocasionar lesiones graves, incluso mortales.</i></p>
---	--

- En caso de almacenamiento, la bomba de calor se debe almacenar en una habitación bien ventilada y con una superficie de más de A_{\min} (m²) dada por la siguiente fórmula: $A_{\min} = (M / (2,5 \times 0,22759 \times h_0))^2$
M es la carga de refrigerante en el aparato en kg y h₀ es la altura de almacenamiento. Para almacenar sobre el suelo h₀ = 0,6 m.
- La bomba de calor está exclusivamente prevista para instalar al exterior de edificios.
- La unidad debe ser instalada por un personal calificado.
- No instalar la bomba de calor sobre un soporte que pueda amplificar las vibraciones de la unidad.
- Verificar que el soporte previsto para la unidad está correctamente dimensionado para el peso del aparato.
- No instalar la bomba de calor en un lugar que pueda amplificar su nivel sonoro o en un lugar donde el ruido de la unidad pueda molestar a los vecinos.
- Todas las conexiones eléctricas deben ser efectuadas por un electricista profesional calificado y según las normas vigentes en el país de instalación, ver § 3.4.
- Cortar la aplicación principal y el seccionador antes de cualquier trabajo eléctrico. Todo olvido puede causar electrocución.
- Antes de la instalación, verificar que el cable de tierra no está cortado ni desconectado.

1. PREFACIO (continuación)

- Conectar y apretar convenientemente el cable de alimentación eléctrica. Si la conexión es incorrecta, las partes eléctricas se pueden dañar.
- La exposición de la bomba de calor al agua o a un medio húmedo puede provocar una electrocución. Esté muy vigilante.
- Si detecta cualquier defecto o situación anormal, no instale la bomba de calor y contacte inmediatamente con su revendedor.
- El mantenimiento y las diferentes operaciones se deben realizar a la frecuencia y en los momentos recomendados, como se especifica en el presente manual.
- Las reparaciones deben ser efectuadas por un personal calificado.
- Solo utilice piezas de recambio originales.
- Nunca utilizar otro procedimiento de limpieza que no sea el recomendado en este manual.

Informaciones importantes referentes al refrigerante utilizado.

Este producto contiene gases fluorados de efecto invernadero enmarcados por el protocolo de Kioto. No libere estos gases a la atmósfera.

Tipo de refrigerante: R32

Valor GWP(1): 675, valor basado en el 4to informe del IPCC.

La cantidad de refrigerante basada en el reglamento n.º 517/2014 (F-Gas) se indica en la placa de características de la unidad.

En función de la legislación europea o local, se pueden exigir inspecciones periódicas de fuga del refrigerante. Contacte con su distribuidor local para más informaciones.

(1) Potencial de calentamiento global

2. CARACTERÍSTICAS TÉCNICAS

2.1 Datos técnicos de la bomba de calor

Modelos	ENERGYLINE PRO INVERTER	ENPI4M	ENPI6M
Tensión de alimentación	V	220V-240V ~ / 1ph / 50Hz	
Refrigerante	/	R32	
Carga	kg	0,50	0,65
Masa en tCO ₂ eq	/	0,34	0,44
Frecuencia de control de fuga	/	Ninguna exigencia, pero se recomienda una vez al año	
Capacidad de calentamiento Mín--Máx ^(a)	kW	2,50--9,73	3,20--11,9
Potencia eléctrica absorbida Mín--Máx ^(a)	kW	0,20--1,34	0,28--1,68
Corriente nominal de servicio Mín--Máx ^(a)	A	1,33--6,02	1,34--7,32
COP Máx--Mín ^(a)	/	12,32--7,12	11,51--7,10
Capacidad de calentamiento Mín--Máx ^(b)	kW	1,71--7,60	2,70--9,70
Potencia eléctrica absorbida Mín--Máx ^(b)	kW	0,27--1,49	0,44--1,88
COP Máx--Mín ^(b)	/	6,40--5,1	6,10--5,55
Corriente máxima de servicio (CMS)	A	7,30	8,90
Calibre del fusible	aM	8	10
Disyuntor curva D	D	8	10
Intensidad por arranque	A	< CMS	< CMS
Conexión hidráulica	mm	50mm	
Caudal nominal de agua ^(a)	m ³ /h	4,20	5,10
Pérdida de carga máxima en el agua	kPa	3,3	4,5
Compresor	/	DC Inverter Mitsubishi	DC Inverter Highly
Tipo	/	Rotativo doble	Rotativo doble
Cantidad	/	1	
Resistencia de enrollado a 20°C	Ohmio	1,91	0,788
Ventilador	/	Axial	
Cantidad	/	1	
Diámetro	mm	405	510
Cantidad de aletas	/	3	
Motor	/	Inversor CD	
Cantidad	/	1	1
Velocidad de rotación	rpm	500--700	500-650
Velocidad modo silencio	rpm	300	400
Nivel de presión acústica a 1 m	dB(A)	33--41	33-41
Nivel de presión acústica a 10m	dB(A)	16--25	16--25
Dimensiones netas de la unidad (longitud-ancho-altura)	mm	1046/400/768	
Masa	kg	53	65



(a) Aire seco 27°C - Humedad relativa 78% - Temperatura de entrada del agua 26°C.

(b) Aire seco 15°C - Humedad relativa 71% - Temperatura de entrada del agua 26°C.

2. CARACTERÍSTICAS TÉCNICAS (continuación)

2.2 Margen de funcionamiento

Utilizar la bomba de calor dentro de los siguientes márgenes de temperatura y de humedad para garantizar un funcionamiento seguro y eficaz.

	Modo calentamiento 	Modo enfriamiento 
Temperatura exterior	-12°C – +35°C	+7°C – +43°C
Temperatura del agua	+12°C – +40°C	+8°C – +40°C
Humedad relativa	< 80%	< 80%
Margen de reglaje del punto de referencia	+15°C – +32°C	+8°C – +32°C



Si la temperatura o la humedad no corresponden a estas condiciones, los dispositivos de seguridad pueden activarse y la bomba de calor puede no funcionar.



La temperatura máxima de calentamiento está limitada a 32°C para evitar el deterioro de los revestimientos. Hayward no se hace responsable en el caso de un uso por encima de +32°C.

2. CARACTERÍSTICAS TÉCNICAS (continuación)

2.3 Dimensiones

Modelos:

ENPI4M / ENPI6M

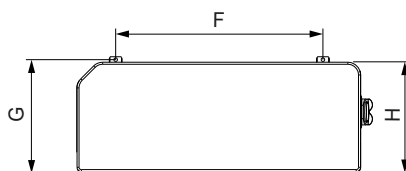
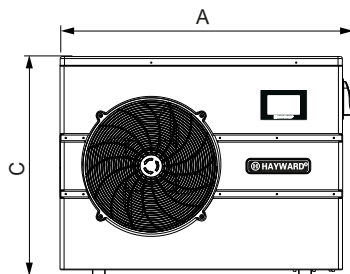
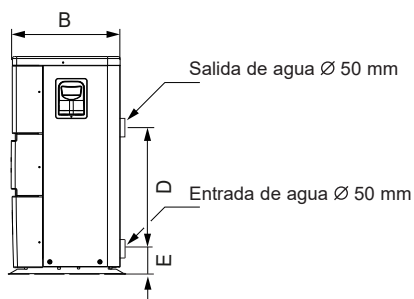

Unidad : mm

Referencia \ Modelo	ENPI4M / ENPI6M
A	1046
B	400
C	768
D	350
E	110
F	615
G	428
H	400

3. INSTALACIÓN Y CONEXIÓN

3.1 Esquema eléctrico

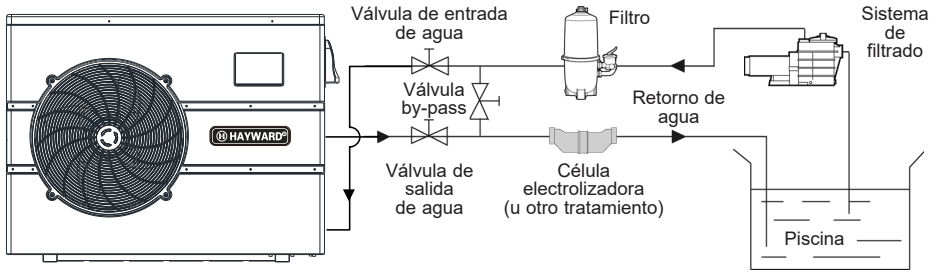

Nota: La bomba de calor se suministra sin ningún equipo de tratamiento o filtración. Los elementos que aparecen en el esquema son las piezas que deberá proporcionar el instalador.

3.2 Bomba de calor



Colocar la bomba de calor en el exterior y fuera de cualquier sala técnica cerrado.

Colocar en una zona resguarda, las distancias mínimas que a continuación se prescriben deben ser respetadas a fin de evitar cualquier riesgo de recirculación del aire y de una degradación del rendimiento global de la bomba de calor.

Unidad: mm

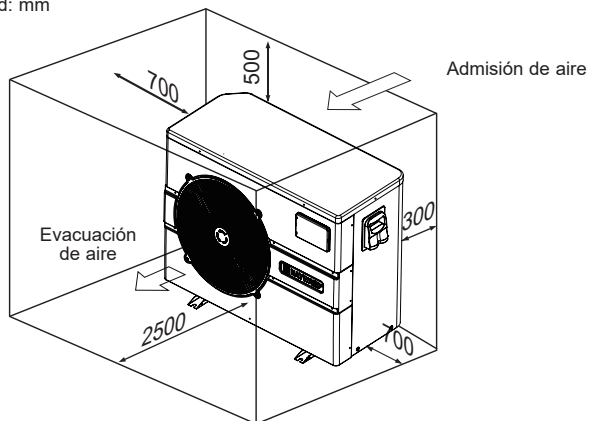

3. INSTALACIÓN Y CONEXIÓN (continuación)



Preferiblemente instale la bomba de calor sobre una superficie de hormigón aislada o una silla de fijación prevista a tal fin y monte la bomba de calor sobre los silentblocs suministrados (los tornillos y arandelas no se suministran).

Distancia máxima de instalación entre la bomba de calor y la piscina 15 metros.

Longitud total de ida-vuelta de las canalizaciones hidráulicas 30 metros.

Aislar las canalizaciones hidráulicas de superficie y enterradas.

La bomba de calor debe instalarse a una distancia mínima de la piscina en cumplimiento de la NF C 15-100 (es decir a 3,5 m de la piscina para Francia) o según las normas de instalación vigentes en el resto de países.

No instalar la bomba de calor cerca de una fuente de calor.

En caso de instalación en regiones nevosas, se recomienda poner la máquina a resguardo para evitar una acumulación de nieve sobre el evaporador.

3.3 Conexión hidráulica

La bomba de calor se suministra con dos conexiones de unión de 50 mm de diámetro. Utilice un tubo de PVC para la canalización hidráulica Ø 50 mm. Conecte la entrada de agua de la bomba de calor al conducto proveniente del grupo de filtración, tras esto conecte la salida de agua de la bomba de calor al conducto de agua que va a la piscina (cf esquema de abajo).

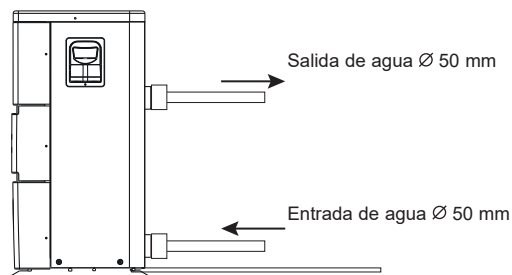

Instale una válvula "by-pass" entre la entrada y la salida de la bomba de calor.



Si se utiliza un distribuidor automático o un electrolizador, se debe instalar obligatoriamente después de la bomba de calor con el fin de proteger el condensador de titanio de una concentración demasiado grande de producto químico.



Se ruega instale la válvula by-pass y las conexiones de unión suministradas al nivel de la entrada y la salida de agua de la unidad, con el fin de simplificar la purga durante el periodo invernal y de facilitar el acceso o el desmontaje para el mantenimiento.

3. INSTALACIÓN Y CONEXIÓN (continuación)

3.4 Conexión eléctrica



La instalación eléctrica y el cableado de este equipo debe cumplir con la normativa de instalación local en vigor.

F	NF C15-100	GB	BS7671:1992
D	DIN VDE 0100-702	EW	EVHS-HD 384-7-702
A	ÖVE 8001-4-702	H	MSZ 2364-702/1994/MSZ 10-553 1/1990
E	UNE 20460-7-702 1993, RECBT ITC-BT-31 2002	M	MSA HD 384-7-702.S2
IRL	Wiring Rules + IS HD 384-7-702	PL	PN-IEC 60364-7-702:1999
I	CEI 64-8/7	CZ	CSN 33 2000 7-702
LUX	384-7.702 S2	SK	STN 33 2000-7-702
NL	NEN 1010-7-702	SLO	SIST HD 384-7-702.S2
P	RSIUEE	TR	TS IEC 60364-7-702



Compruebe que la alimentación eléctrica disponible y la frecuencia de la red corresponden con la corriente de funcionamiento requerida, teniendo en consideración el emplazamiento específico del aparato y la corriente necesaria para alimentar cualquier otro aparato que esté conectado al mismo circuito.

ENPI4M 230V \sim +/- 10 % 50 Hz 1 Fase

ENPI6M 230V \sim +/- 10 % 50 Hz 1 Fase

Observe el esquema de cableado correspondiente en el anexo.

La caja de conexiones se encuentra en el lado derecho de la unidad.

Hay tres conexiones destinadas a la alimentación eléctrica y dos para el control del sistema de filtrado (servomecanismo).

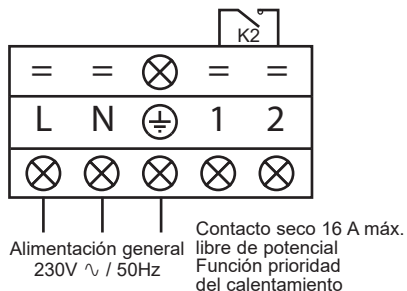

3. INSTALACIÓN Y CONEXIÓN (continuación)



La línea de alimentación eléctrica debe estar dotada, de manera apropiada, de un dispositivo de protección del tipo fusible de acompañamiento del motor (aM) o disyuntor curva D, así como de un disyuntor diferencial 30mA (ver tabla a continuación).

Modelos		ENPI4M	ENPI6M
Alimentación eléctrica	V/Ph/Hz	230V~ 50Hz	230V~ 50Hz
Calibre de fusible tipo aM	A	8 aM	10 aM
Disyuntor curva D	A	8 D	10 D
Sección de cable	mm ²	3G 2,5	3G 2,5



Use un cable de alimentación de tipo RO 2 V / R 2 V o equivalente.



Las secciones de cable indicadas se corresponden a una longitud máxima de 25 m. Sin embargo, deben comprobarse y adaptarse en función de las condiciones de instalación.



Tenga siempre cuidado de detener la alimentación principal antes de abrir la caja de control eléctrico.

3.5 Primer arranque

Procedimiento de arranque - una vez que se ha terminado la instalación, siga y respete las siguientes etapas:

- 1) Gire los ventiladores con la mano para comprobar que pueden girar libremente y que la hélice está correctamente fijada al árbol del motor.
- 2) Asegúrese de que la unidad está conectada correctamente a la alimentación principal (ver el esquema de cableado en el anexo).
- 3) Active el sistema de filtrado.
- 4) Verifique que todas las válvulas de agua están abiertas y que el agua circula hacia la unidad antes de pasar al modo de calentamiento o enfriamiento.
- 5) Verifique que la acometida de purga de condensados está fijada correctamente y no presenta ninguna obstrucción.
- 6) Activar la alimentación eléctrica destinada a la unidad, después presione el botón de Marcha/Parada  sobre el panel de control.

3. INSTALACIÓN Y CONEXIÓN (continuación)

- 7) Asegúrese de que no se encienda en rojo la señal de alarma (Δ). Dado el caso, consultar la guía de solución de averías (ver § 6.4).
- 8) Fije el caudal de agua con la ayuda de la válvula by-pass (ver § 3.6 y 2.1), tal y como se prevee respectivamente para cada modelo de manera que obtenga una diferencia de temperatura Entrada/ Salida de 2°C.
- 9) Tras estar funcionando unos cuantos minutos, verifique que el aire sale de la unidad y se enfría (entre 5 y 10°).
- 10) Estando la unidad en servicio, desactive el sistema de filtrado. La unidad debe pararse automáticamente y mostrar el código de error E03.
- 11) Haga funcionar la unidad y la bomba de la piscina durante 24 horas seguidas, hasta que se alcance la temperatura del agua deseada. Cuando la temperatura de entrada del agua alcance el valor de referencia, la unidad se para. Se pone en funcionamiento de nuevo automáticamente (siempre que la bomba de la piscina esté en servicio) si la temperatura desciende menos de 0,5°C por debajo de la temperatura de referencia.

Controlador del caudal - La unidad está dotada de un controlador de caudal que activa la bomba de calor mientras el sistema de filtrado de la piscina está en servicio y la desactiva cuando el sistema de filtrado está fuera de servicio. Por falta de agua, el código de alarma E03 aparece en el reguador (Ver § 6.4).

Temporización - la unidad integra una temporización de 3 minutos, que tiene por objeto proteger los componentes del circuito de control, eliminar cualquier inestabilidad en el arranque y cualquier interferencia del contactor. Por medio de esta temporización, la unidad arranca de nuevo automáticamente unos 3 minutos después de que se produzca un corte del circuito de control. Incluso un corte de corriente de corta duración activa la temporización de arranque.

3. INSTALACIÓN Y CONEXIÓN (continuación)

3.6 Ajuste del caudal de agua

Con las válvulas de entrada y salida de agua abiertas, ajustar la válvula "by-pass" de forma que se obtenga una diferencia de 2°C entre la temperatura de entrada y de la salida del agua (ver el esquema eléctrico § 3.1). Puede verificar el ajuste visualizando las temperaturas de entrada/salida directamente sobre el panel de control.



Nota: La apertura de la válvula "by-pass" genera un caudal menor, lo cual conlleva un aumento de ΔT .
El cierre de la válvula "by-pass" genera un caudal mayor, lo cual conlleva una disminución de ΔT .

4. INTERFAZ USUARIO

4.1 Presentación general

La bomba de calor está equipada con un panel de control digital con pantalla táctil, el cual ha sido previamente conectado eléctricamente y programado en fábrica para funcionar en modo calentamiento.

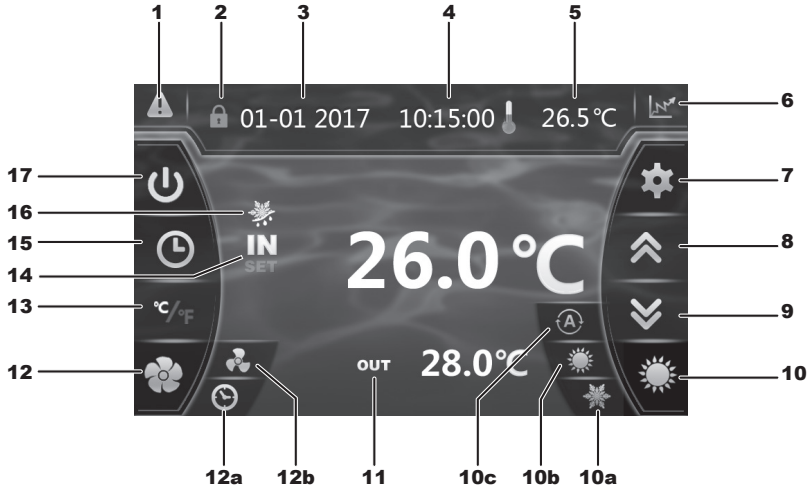

Legenda

1		Alarma (rojo intermitente)
2		Pantalla bloqueada
3		Fecha
4		Tiempo
5		Temperatura exterior
6		Base de registro (temperatura del agua y potencia absorbida)
7		Lectura y conservación de los parámetros
8		Desfilar arriba / Aumentar
9		Desfilar abajo / Reducir
10		Selección del modo de funcionamiento
10a		Modo enfriamiento

10b		Modo calentamiento
10c		Modo automático
11		Temperatura de salida del agua
12		Selección del modo silencioso
12a		Ajuste del temporizador en modo silencioso
12b		Testigo de modo silencioso y activación
13		Conversión °C/°F
14		Temperatura de entrada del agua
15		Ajuste de la fecha y de la hora temporizador ON/OFF
16		Modo deshielo
17		Marcha / Parada

4. INTERFAZ USUARIO (continuación)

Modo OFF

Cuando la bomba de calor está en espera (Modo OFF) aparece "OFF" en la pantalla del regulador, el botón está  en gris

Modo ON

Cuando la bomba de calor está en funcionamiento o en regulación (Modo ON) las temperaturas de entrada y salida del agua aparecen en la pantalla del regulador, el botón se enciende  en verde.

4.2 Ajuste de la fecha y de la hora

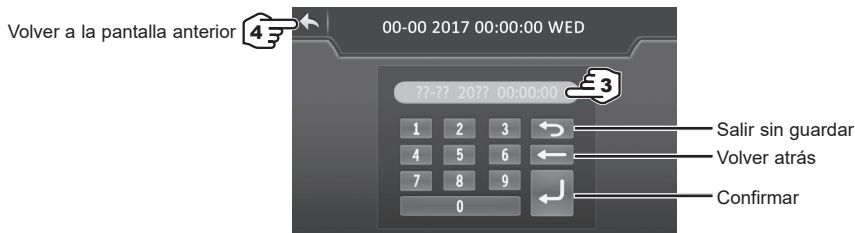

Introducir todos los campos (día/mes/año, horas/minutos/segundos) antes de confirmar, de lo contrario las modificaciones no se guardarán.

4.3 Ajuste de la función Timer

El ajuste de esta función será necesario cuando usted desee hacer funcionar su bomba de calor durante un periodo de tiempo más corto que el determinado por el reloj de filtración. De esta forma podrá programar un arranque retardado y una parada anticipada o simplemente prohibir un periodo horario de funcionamiento (por ejemplo la noche).

Tiene la posibilidad de programar 1 Timer de Marcha y 1 Timer de Parada.

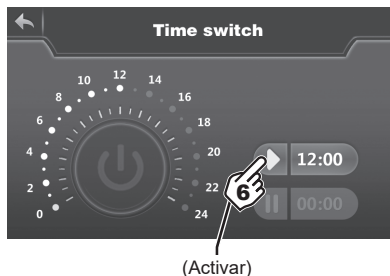
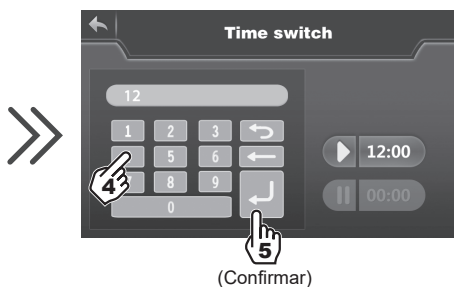
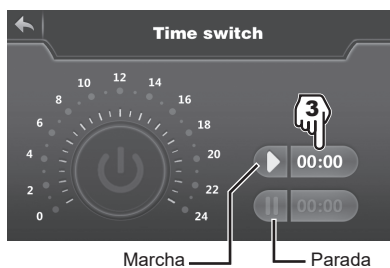
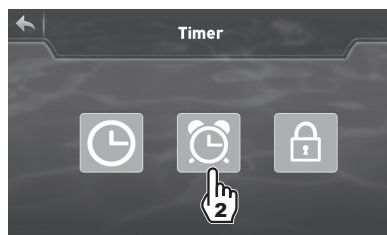
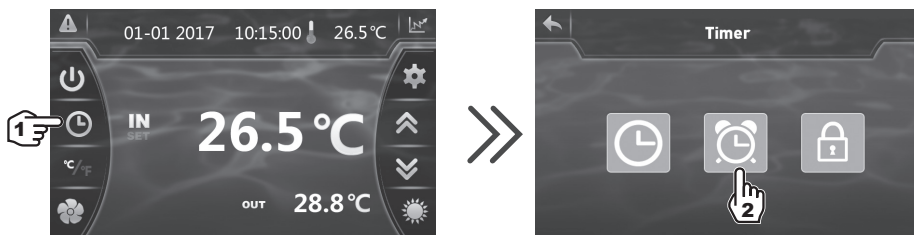

4. INTERFAZ USUARIO (continuación)



Resaltado en azul = Activado
Gris = Desactivado



El paso de ajuste es «de hora en hora».



- Una vez ajustada la hora de inicio, pulse  (etapa 6) para activar el temporizador. El símbolo y la hora se resaltan en azul.
- Repetir las etapas de 3 a 6 para ajustar y activar la hora de parada ( 00:00).
- Una vez terminados los ajustes, el intervalo de funcionamiento de la bomba de calor aparecerá resaltado en verde y el intervalo de parada resaltado en amarillo.
- Pulsar 2 veces  para volver a la pantalla principal.

4. INTERFAZ USUARIO (continuación)

4.4 Ajuste y visualización del punto de referencia



En Modo “OFF” y Modo “ON”

Presione  para visualizar el punto de consigna, y después pulsar  o  para definir el punto de consigna deseado.

Confirmar pulsando , volverá a la pantalla principal de forma automática.



El ajuste se efectúa con una precisión de 0,5 °C



Se recomienda no sobrepasar jamás la temperatura de 30°C para evitar la alteración de los liners.

4. INTERFAZ USUARIO (continuación)

4.5 Apertura y bloqueo automático de la pantalla táctil

La pantalla de control se bloqueará automáticamente transcurrido un minuto (ajuste predeterminado).

Se puede ajustar entre 1 y 10 minutos el tiempo antes de que la pantalla se bloquee automáticamente o simplemente cancelar esta función.



Bloqueo automático activado

- 3) Ajustar el tiempo entre 1 y 10 minutos. El guardado es automático.
- 4) Pulsar 2 veces para volver a la pantalla principal.5)
- 5) Para desactivar el bloqueo automático, pulsar .

Para desbloquear la pantalla, pulsar (en cualquier sitio) la pantalla durante 2 s. Introducir el código "22" y confirmar pulsando .



4. INTERFAZ USUARIO (continuación)

4.6 Ajuste del modo silencioso

El modo silencioso permite usar la bomba de calor en modo ahorro y de forma muy silenciosa cuando las necesidades de calentamiento son bajas (para mantener la temperatura de la piscina o en caso de necesitar un funcionamiento ultrasilencioso).

Esta función se puede Activar / Desactivar manualmente o con un temporizador.

Activación manual



Modo silencioso activado

4. INTERFAZ USUARIO (continuación)

Desactivación manual



Modo silencioso desactivado

Ajuste del temporizador

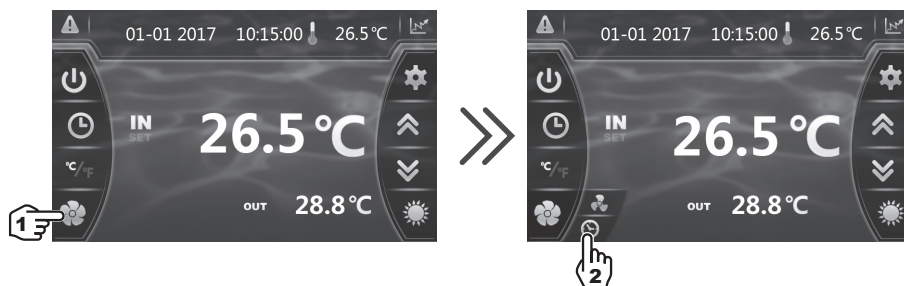

4. INTERFAZ USUARIO (continuación)

Ajuste del temporizador (continuación)

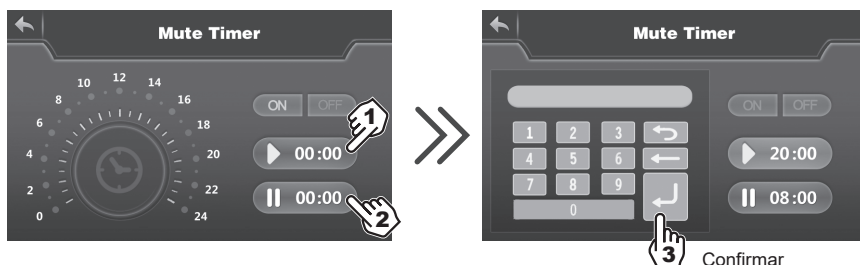

- 1) Hora de inicio, introducción y confirmación.
- 2) Hora de fin, introducción y confirmación.
- 3) Confirmar.



- 4) Activación.
- 5) Desactivación.
- 6) Volver a la pantalla principal.



El paso de ajuste es «de hora en hora».

Una vez que el temporizador esté activado, permanecerá activo los 7 días de la semana.

5. MANTENIMIENTO E INVIERNO

5.1 Mantenimiento

Estas operaciones de mantenimiento deben realizarse 1 vez al año con el fin de garantizar la longevidad y el buen funcionamiento de la bomba de calor.

- Limpie el evaporador con un cepillo flexible o de un chorro de aire o agua (**Atención no utilizar jamás un limpiador de alta presión**).
- Verifique el buen flujo de los condensados.
- Compruebe la fijación de las conexiones hidráulicas y eléctricas
- Compruebe la estanqueidad hidráulica del condensador.
- **Un profesional autorizado** deberá comprobar la estanqueidad del circuito frigorífico con un detector de fugas.



Antes de realizar cualquier operación de mantenimiento, la bomba de calor debe estar desconectada de cualquier fuente de corriente eléctrica. Las operaciones de mantenimiento deben ser realizadas únicamente por personal cualificado y capacitado para manipular fluidos frigorígenos.

5.2 Invierno

- Poner la bomba de calor en Modo "OFF".
- Cortar la alimentación de la bomba de calor.
- Vaciar el condensador a través del desagüe para evitar cualquier riesgo de degradación. (riesgo importante de congelación).
- Cerrar la válvula "by-pass" y desatornillar las conexiones de unión entrada/salida.
- Expulse toda el agua estancada residual del condensador ayudándose con una pistola de aire.
- Obture la entrada y la salida de agua a la bomba de calor para evitar la intrusión de cuerpos extraños.
- Cubrir la bomba de calor con una funda de protección para el invierno.



Cualquier daño ocasionado por un mal mantenimiento invernal conlleva la anulación de la garantía.

6. ANEXOS

6.1 Esquemas eléctricos

ENPI4M

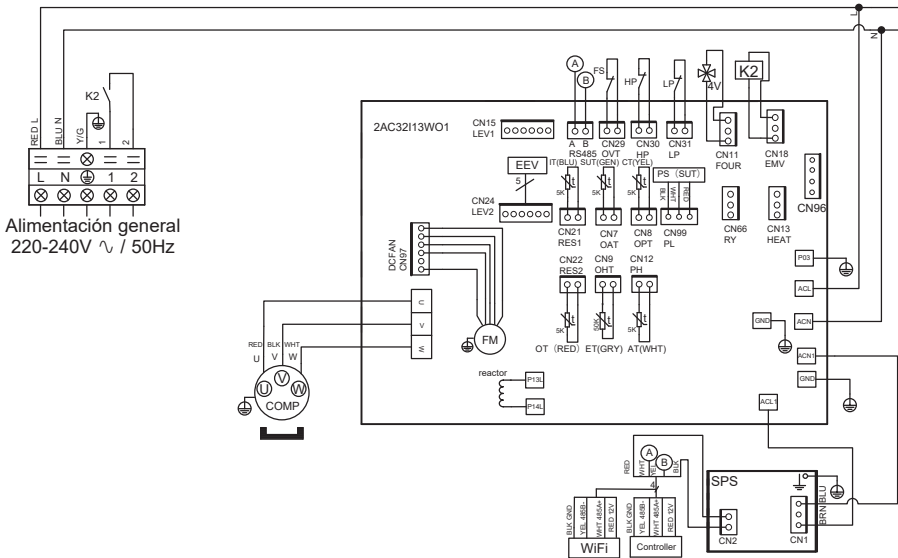

LEYENDA

- AT : SONDA DE TEMPERATURA DE AIRE
- COMP : COMPRESOR
- CT : SONDA DE TEMPERATURA EVAPORADOR
- EEV : DESCOMPRESOR ELECTRONICO
- FM : MOTOR VENTILADOR
- FS : DETECTOR DE PRESENCIA DE AGUA
- HP : PRESOSTATO ALTA PRESIÓN
- IT : SONDA DE TEMPERATURA DE ENTRADA DE AGUA

- LP : PRESOSTATO BAJA PRESIÓN
- OT : ONDA DE TEMPERATURA DE ENTRADA DE AGUA
- SUT : SONDA DE TEMPERATURA DE ASPIRACIÓN
- 4V : VÁLVULA 4 VÍAS
- K2 : CONTACTO SECO LIBRE DE 16 A MÁX.
- ET : SONDA DE TEMPERATURA DE DESCARGA
- PS : SENSOR DE PRESIÓN

6. ANEXOS (continuación)

ENPI6M

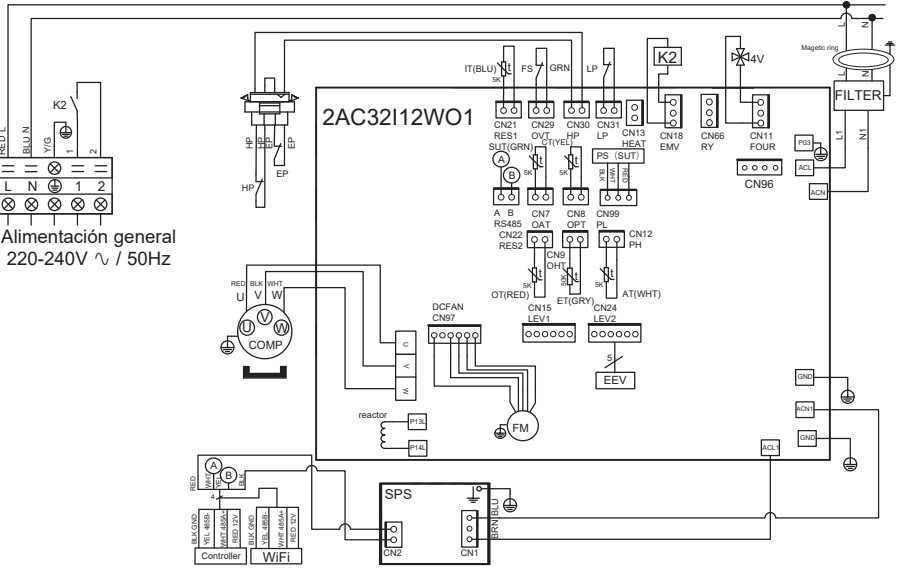

LEYENDA

- | | |
|---|--|
| <p>AT : SONDA DE TEMPERATURA DE AIRE</p> <p>COMP : COMPRESOR</p> <p>CT : SONDA DE TEMPERATURA EVAPORADOR</p> <p>EEV : DESCOMPRESOR ELECTRÓNICO</p> <p>FM : MOTOR VENTILADOR</p> <p>FS : DETECTOR DE PRESENCIA DE AGUA</p> <p>HP : PRESOSTATO ALTA PRESIÓN</p> <p>IT : SONDA DE TEMPERATURA DE ENTRADA DE AGUA</p> | <p>LP : PRESOSTATO BAJA PRESIÓN</p> <p>OT : ONDA DE TEMPERATURA DE ENTRADA DE AGUA</p> <p>SUT : SONDA DE TEMPERATURA DE ASPIRACIÓN</p> <p>4V : VÁLVULA 4 VÍAS</p> <p>K2 : CONTACTO SECO LIBRE DE 16 A MÁX.</p> <p>ET : SONDA DE TEMPERATURA DE DESCARGA</p> <p>PS : SENSOR DE PRESIÓN</p> |
|---|--|

6. ANEXOS (continuación)

6.2 Conexiones con prioridad al calentador de bomba monofásico

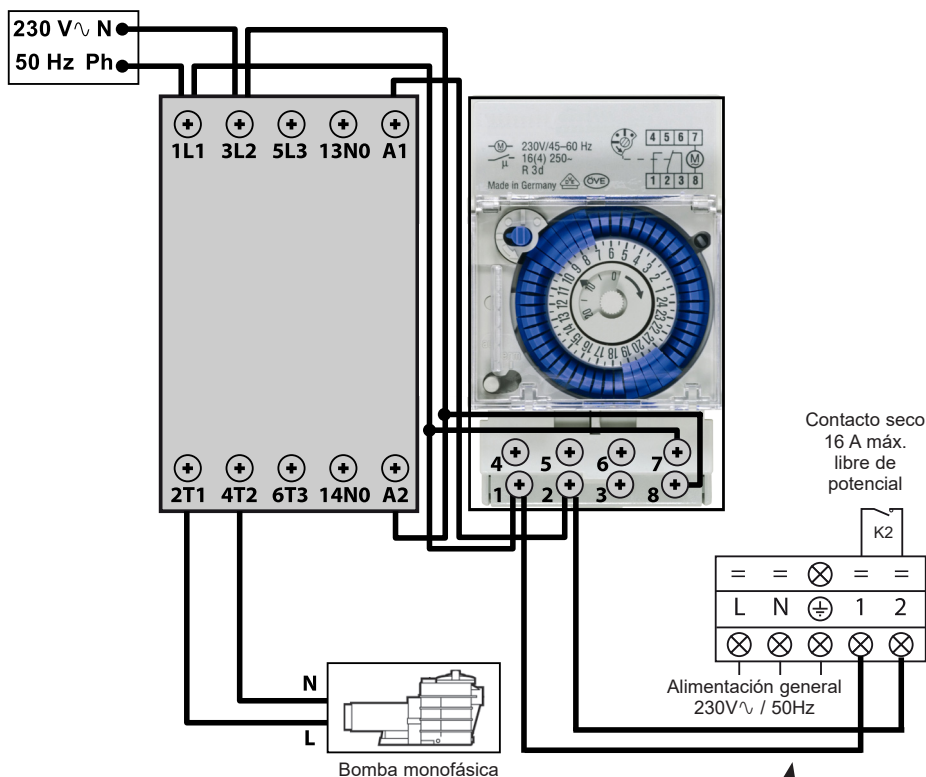

Los bornes 1 et 2 suministran un contacto seco (libre de potencial), sin polaridad de 230 V \sim / 50 Hz.

Conecte los cables a los bornes 1 y 2 respetando el esquema de cableado que se indica a continuación para que la bomba de filtración funcione por ciclos de 2 min cada hora en caso de que la temperatura de la piscina sea inferior al punto de consigna.

 No conecte nunca la alimentación de la bomba de filtración directamente a los bornes 1 y 2.



Página en blanco intencionalmente

6. ANEXOS (continuación)

6.3 Despiece y piezas de recambio

ENPI4M / ENPI6M

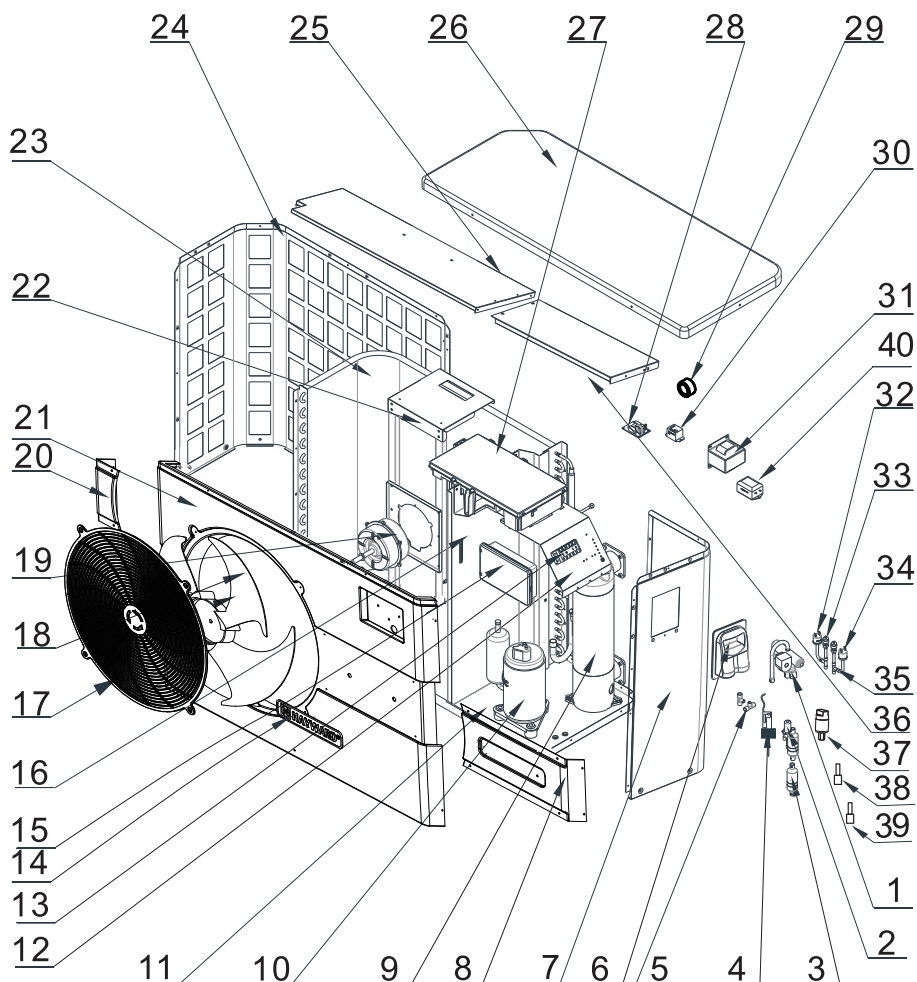

6. ANEXOS (continuación)

ENPI4M / ENPI6M

Rep	Ref.	Designación	ENPI4M	ENPI6M
1	Válvula 4 vías	HWX20041437	✓	✓
2	Descompresor electrónico	HWX81000015	✓	n/a
		HWX81000016	n/a	✓
3	Filtro ø9.7-ø9.7 (Ø28)	HWX20041444	✓	✓
4	Detector del caudal de agua	HWX83000012	✓	✓
5	Conector en T ø9.52-2 x ø6.5(T) x 1.0	HWX304030000002	✓	✓
6	Trampilla de acceso eléctrico	HWX320922029	✓	✓
7	Panel derecho	HWX80700455	✓	✓
8	Panel decorativo derecho	HWX80900089	✓	✓
9	Condensador de titanio/PVC	HWX80600074	✓	n/a
		HWX80600096	n/a	✓
10	Compresor	HWX20000110448	✓	n/a
		HWX80100003	n/a	✓
11	/	/	/	/
12	/	/	/	/
13	Borna L-N-GND -5 conexiones 4mm ²	HWX40003901	✓	✓
14	Logo HAYWARD	HWX20000230596	✓	✓
15	Pantalla táctil en color	HWX95005310612	✓	✓
16	/	/	/	/
17	Rejilla de protección del ventilador	HWX20000220169	✓	✓
18	Hélice ventilador	HWX20000270004	✓	✓
19	Motor ventilador CC	HWX20000330132	✓	✓
20	Panel decorativo izquierdo	HWX80900088	✓	✓
21	Panel delantero	HWX80900087	✓	✓
22	Soporte del motor	HWX80700248	✓	✓
		HWX80600044	✓	n/a
23	Evaporador de aleta	HWX80600100	n/a	✓
24	Panel de la izquierda	HWX80700455	✓	✓
25	/	/	/	/
26	Panel superior	HWX301090200806	✓	✓
		HWX82300008	✓	n/a
27	Tarjeta electrónica Driver	HWX82300007	n/a	✓
		HWX82600008	✓	✓
28	Transformador 230V~/12VDC	HWX82600008	✓	✓
29	/	/	/	/
30	Relé K2	HWX20000360297	✓	✓
31	Bobina 20A 50Hz 5mH	HWX82500005	✓	✓
32	Presostato baja presión NO 0.30MPa/0.15MPa	HWX20000360157	✓	✓
33	Toma de presión 40 mm 1/2"	HWX20000140150	✓	✓
34	Presostato de alta presión NC 3.2MPa/4.4MPa	HWX20013605	✓	✓
35	Conector en T ø6.5-2 x ø6.5(T) x 0.75T2M	HWX20001460	✓	✓
36	/	/	/	/
37	Sensor de presión	HWX20000360123	✓	✓
38	Sonda de descarga compresor 50 kΩ-660mm	HWX83000026	✓	✓
39	Sonda de temperatura de aire 5k-350mm	HWX83000049	✓	✓
	Sonda de salida de agua 5k-410mm	HWX83000050	✓	✓
	Sonda de entrada de agua 5k-850mm	HWX83000052	✓	✓
	Sonda de aspiración compresor 5k-560mm	HWX83000044	✓	✓
	Sonda de descongelación 5k-680mm	HWX83000051	✓	✓
40	Filtro EMC	HWX20003257	n/a	✓

6. ANEXOS (continuación)

6.4 Guía de reparación



Algunas operaciones deben ser realizadas por un técnico habilitado..

En caso de fallo en la bomba de calor, el símbolo  aparecerá en rojo intermitente en la esquina izquierda de la pantalla.

Pulsar el símbolo  para acceder a la lista de errores.

Consulte la tabla siguiente.

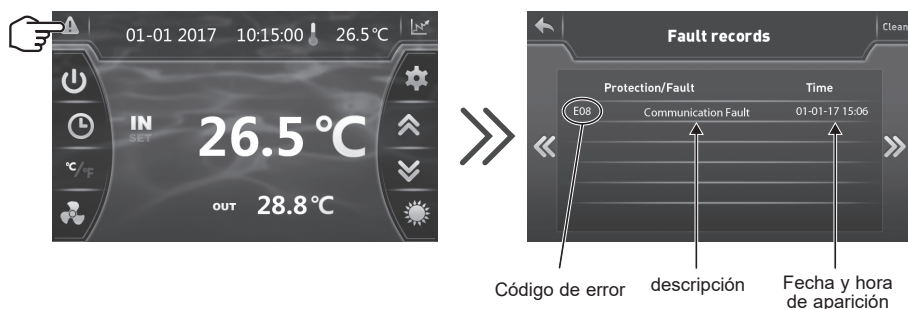



Protection/Fault	Time
E08	01-01-17 15:06
Communication Fault	

Código de error descripción Fecha y hora de aparición



Después de resolver el problema, el error desaparecerá automáticamente, el triángulo pasará a gris fijo.



Para borrar la lista de errores, pulsar  y volver a la pantalla anterior pulsando .

6. ANEXOS (continuación)

Fallo	Códigos de error	Descripción	Solución
Fallo de la sonda de entrada de agua	P01	El sensor está abierto o presenta un cortocircuito.	Verificar la conexión CN21/RES1 en la tarjeta y el conector prolongación o reemplazar el captador
Fallo de la sonda de salida de agua	P02		Verificar la conexión N22/RES2 en la tarjeta y el conector prolongación o reemplazar el captador
Fallo de la sonda de temperatura exterior	P04		Verificar la conexión CN12/PH en la tarjeta y el conector prolongación o reemplazar el captador
Fallo de la sonda de descongelación	P05		Verificar la conexión CN8/OPT en la tarjeta y el conector prolongación o reemplazar el captador
Fallo de la sonda de aspiración del compresor	P07		Verificar la conexión CN7/OAT en la tarjeta y el conector prolongación o reemplazar el captador
Fallo de la sonda de recirculación del compresor	P081		Verificar la conexión CN9/OHT en la tarjeta y el conector prolongación o reemplazar el captador
Protección alta presión	E01	El sensor está abierto o presenta un cortocircuito.	<p>Verificar la conexión CN30/HP en la tarjeta o sustituir el sensor</p> <p>Comprobar el caudal de agua</p> <p>Comprobar el detector del flujo de agua</p> <p>Comprobar la apertura de las válvulas</p> <p>Comprobar el by-pass</p> <p>Comprobar el estado de suciedad del evaporador</p> <p>Temperatura del agua demasiado caliente</p> <p>En caso de problema de incondensables tras un mantenimiento, vaciar y eliminar la humedad del circuito frigorífico</p> <p>Carga de fluido demasiado importante, retirar fluido en una botella de líquido</p>
Protección baja presión	E02	El sensor está abierto o presenta un cortocircuito.	<p>Comprobar la conexión AI/DI03 en la tarjeta o sustituir el sensor</p> <p>Fuga importante de fluido frigorígeno, buscar la fuga con el detector</p> <p>Caudal de aire demasiado bajo, comprobar la velocidad de rotación del ventilador</p> <p>Comprobar el estado de suciedad del evaporador, limpiar la superficie</p>
Fallo del detector de caudal	E03	El sensor está abierto o presenta un cortocircuito.	<p>Comprobar la conexión AI/DI02 en la tarjeta o sustituir el sensor</p> <p>Falta de agua, comprobar el funcionamiento de la bomba de filtración</p> <p>Comprobar la apertura de las válvulas de parada</p> <p>Comprobar el ajuste del by-pass</p>

6. ANEXOS (continuación)

Fallo	Códigos de error	Descripción	Solución
Diferencia de temperatura Entrada/ Salida > 13 °C	E06	Aplicable en modo frío solamente	Falta de agua, comprobar el funcionamiento de la bomba de filtración
			Comprobar la apertura de las válvulas de parada
			Comprobar el ajuste del by-pass
Protección anticongelante Modo frío	E07	Temperatura de salida del agua < a 4 °C	Detener la bomba de calor, vaciar el condensador de riesgo de heladas
Problema de comunicación	E08	No hay comunicación entre la tarjeta electrónica y la interfaz usuario	Verificar las conexiones y la conéctica - ver esquema eléctrico
Protección anticongelante de nivel 1	E19	2° < temperatura del agua < 4° y temperatura del aire < 0°	Detener el funcionamiento de la bomba de calor, vaciar el condensador para evitar las heladas. De forma predeterminada, la bomba de calor activará la bomba de filtración y la bomba de calor para evitar la formación de hielo.
Protección anticongelante de nivel 2	E29	Temperatura del agua < 2° y temperatura del aire < 0°	Detener el funcionamiento de la bomba de calor, vaciar el condensador para evitar las heladas. De forma predeterminada, la bomba de calor activará la bomba de filtración y la bomba de calor para evitar la formación de hielo.
Defecto del motor del ventilador	F031	Motor bloqueado o defecto de conexión	Verificar la rotación libre y la conéctica CN97/DCFan, reemplazar el motor
Defecto del motor del ventilador	F051	Defecto de conexión	Verificar la conéctica DCFAN/CN97, reemplazar el motor
Temperatura exterior demasiado baja	TP	Límite de funcionamiento alcanzado	Parar la bomba de calor
Fallo del sensor de presión	PP	El sensor está abierto o presenta un cortocircuito.	Comprobar las conexiones (ver esquema eléctrico)

6. ANEXOS (continuación)

6.5 Base de registro

Desde la pantalla principal, pulsar  para acceder al historial de los registros de las temperaturas de entradas y salidas del agua.



Estos datos se encontrarán disponibles durante 60 días.

Pulsar  para acceder a la potencia eléctrica media consumida.

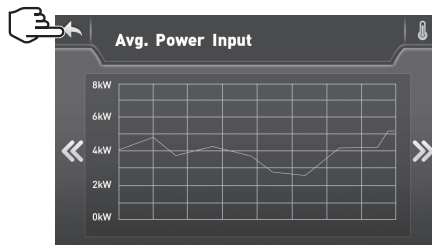
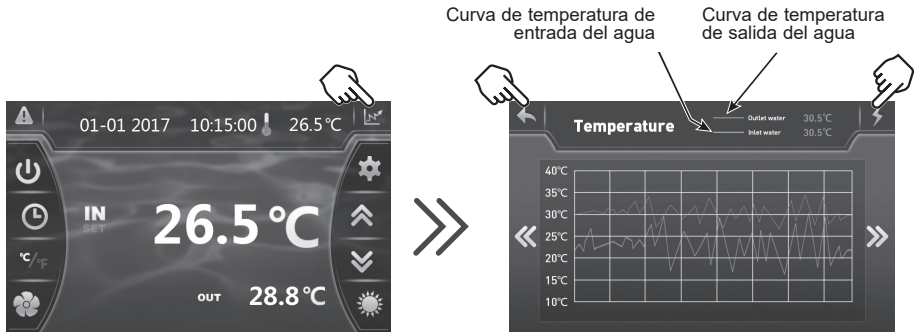

Pulsar  para volver a la pantalla principal.

6. ANEXOS (continuación)

6.6 Garantía

CONDICIONES DE GARANTÍA

Todos los productos HAYWARD están garantizados contra defectos de fabricación y material durante dos años a partir de la fecha de compra. Toda reclamación de garantía debe ir acompañada de una prueba de compra que justifique la fecha. A tal efecto, asegúrese de conservar su factura.

La garantía de HAYWARD se limita a la reparación o sustitución, a elección de HAYWARD, de los productos defectuosos, siempre que se hayan usado en condiciones normales, conforme a las recomendaciones e instrucciones del manual de uso, que no hayan sido objeto de modificación alguna y se hayan utilizado únicamente con componentes y piezas de HAYWARD. Los daños provocados por congelación y agentes químicos no están cubiertos por la garantía.

Todos los demás gastos (transporte, mano de obra, etc.) quedan excluidos de la garantía.

HAYWARD declina toda responsabilidad derivada de daños directos o indirectos causados por una instalación, una conexión o un uso incorrecto del producto.

Para usar la garantía y solicitar la reparación o sustitución de un artículo, póngase en contacto con su distribuidor. No se aceptarán envíos de material a nuestra fábrica sin nuestra aceptación previa por escrito.

Las piezas de desgaste no están cubiertas por la garantía.

ISENPINVR32

ENERGYLINE PRO iNVERTER

BOMBA DE AQUECIMENTO PARA PISCINAS



Manual de instalação e de instruções

RESUMO

1. PREFÁCIO	1
2. CARACTERÍSTICAS TÉCNICAS	4
2.1 Dados técnicos da bomba de aquecimento	4
2.2 Período de funcionamento	5
2.3 Dimensões	6
3. INSTALAÇÃO E LIGAÇÃO	7
3.1 Esquema de princípio	7
3.2 Bomba de aquecimento	7
3.3 Ligação hidráulica	8
3.4 Ligação eléctrica	9
3.5 Primeira colocação em serviço	10
3.6 Ajuste do débito de água	12
4. INTERFACE DO UTILIZADOR	13
4.1 Apresentação geral	13
4.2 Configuração de data e hora	14
4.3 Ajuste da função Timer (temporizador)	14
4.4 Ajuste e visualização do ponto de ajuste	16
4.5 Bloqueio e libertação do ecrã táctil	17
4.6 Ajustamento do modo SILÊNCIO	18
5. MANUTENÇÃO E PREPARAÇÃO PARA O INVERNO	21
5.1 Manutenção	21
5.2 Preparação para o Inverno	21
6. ANEXOS	22
6.1 Esquemas eléctricos	22
6.2 Ligações prioridade aquecimento bomba monofásica	24
6.3 Vistas explodidas e peças sobressalentes	26
6.4 Guia de resolução de avarias	28
6.5 Base de registo	31
6.6 Garantia	32

Ler atentamente e conservar para consulta posterior.

Este documento deve ser entregue ao proprietário da piscina e deve ser conservado por este em local seguro.

1. PREFÁCIO

Agradecemos-lhe pela compra desta bomba de calor para piscina Hayward. A bomba de calor Hayward FULL INVERTER foi concebida segundo estritas normas de fabrico para satisfazer os mais elevados níveis de qualidade requeridos.

As bombas de calor Hayward oferecem-lhe desempenhos excepcionais ao longo de toda a época de utilização da sua piscina, adaptando a potência, o consumo elétrico e o nível sonoro à sua necessidade de aquecimento, graças à lógica de controlo FULL INVERTER.



Leia atentamente as instruções deste manual antes de utilizar o aparelho.

As bombas de calor Hayward são exclusivamente destinadas a aquecer a água da piscina, não utilizar este material para outros fins.

O presente manual inclui todas as informações necessárias sobre a instalação, a eliminação de falhas de funcionamento e a conservação.

Leia atentamente este manual antes de abrir a unidade, ou realizar nesta operações de manutenção. O fabricante deste produto não será em caso algum responsável em caso de ferimento de um utilizador ou de deterioração da unidade consecutivos a eventuais erros aquando da instalação, da eliminação de falhas ou de uma manutenção inútil. É fundamental seguir em todas as ocasiões as instruções especificadas neste manual.

Toda recomendação não respeitada anula a garantia.

2. PREFÁCIO (continuação)



Instruções de segurança



Este aparelho contém R32.

Jamais utilizar um refrigerante diferente do R32. A mistura de qualquer outro elemento gasoso com o R32 pode provocar pressões anormalmente elevadas, suscetíveis de provocar uma avaria ou a rutura de tubos e possíveis ferimentos de pessoas.

Aquando de reparações ou de operações de manutenção, nunca utilizar tubos de cobre cuja espessura seja inferior a 0,8 mm.

A bomba de calor está sob pressão, portanto jamais perfurar os tubos nem tentar efetuar uma brasagem. Há um risco de explosão.

Nunca expor o aparelho a chamas, faíscas ou qualquer outra fonte de ignição. Este poderia explodir e causar ferimentos graves ou mesmo mortais.

- Em caso de armazenamento da bomba de calor, esta deve ser armazenada num local corretamente ventilado que tenha uma superfície no solo superior a A_{\min} (m²), estabelecida pela seguinte fórmula: $A_{\min} = (M / (2,5 \times 0,22759 \times h_0))^2$ M sendo a carga de refrigerante no aparelho em kg e h₀ a altura de armazenamento. Para um armazenamento no solo h₀ = 0,6 m.
- A bomba de calor foi exclusivamente prevista para uma instalação ao exterior dos edifícios.
- A unidade deve ser instalada por pessoal qualificado.
- Não instalar a bomba de calor sobre um suporte suscetível de amplificar as vibrações da unidade.
- Verificar que o suporte previsto para a unidade foi adequadamente dimensionado para o peso do aparelho.
- Não instalar a bomba de calor num lugar suscetível de amplificar o seu nível sonoro ou num lugar onde o ruído da unidade possa incomodar a vizinhança.
- Todas as ligações elétricas devem ser efetuadas por um electricista profissional qualificado e de acordo com as normas em vigor no país de instalação, ver § 3.4.
- Cortar a alimentação principal e o seccionador antes de qualquer trabalho elétrico. Qualquer esquecimento pode ser causa de eletrocussão.
- Antes da instalação, verificar que o cabo de ligação à terra não foi cortado ou desconetado.

2. PREFÁCIO (continuação)

- Conetar e apertar adequadamente o cabo de alimentação elétrica. Se a ligação for incorreta, partes elétricas podem ser danificadas.
- A exposição da bomba de calor à água ou a um ambiente húmido pode provocar uma eletrocussão. Mantenha-se extremamente vigilante.
- Se detetar qualquer defeito ou situação anormal, não instale a bomba de calor e contate imediatamente o seu revendedor.
- A manutenção e as diferentes operações devem ser realizadas conforme a frequência e os momentos recomendados, tal como especificado no presente manual.
- As reparações devem ser efetuadas por pessoal qualificado.
- Utilizar somente peças sobressalentes originais.
- Jamais utilizar um outro processo de limpeza que não seja o preconizado neste manual.

Informações importantes relativas ao refrigerante utilizado.

Este produto contém gases fluorados com efeito de estufa que são enquadrados pelo protocolo de Quioto. Não libertar estes gases na atmosfera.

Tipo de refrigerante: R32

Valor GWP(1): 675, Valor baseado no 4º relatório do GIEC.

A quantidade de refrigerante baseada na regulamentação F-Gás n.º 517/2014 está indicada na placa de identificação da unidade.

Inspeções periódicas de fuga de refrigerante podem ser exigidas em função da legislação europeia ou local. Queira contactar o seu distribuidor local para mais amplas informações.

(1) Potencial de aquecimento global

2. CARACTERÍSTICAS TÉCNICAS

2.1 Dados técnicos da bomba de aquecimento

Modelos	ENERGYLINE PRO INVERTER	ENPI4M	ENPI6M
Tensão de alimentação	V	220V-240V ~ / 1ph / 50Hz	
Refrigerante	/	R32	
Carga	kg	0,50	0,65
Massa em tCO ₂ eq	/	0,34	0,44
Frequência de controlo de fuga	/	Nenhuma exigência mas é recomendado que esta seja anual	
Capacidade de aquecimento Mín--Máx ^(a)	kW	2,50--9,73	3,20--11,9
Potência elétrica absorvida Mín--Máx ^(a)	kW	0,20--1,34	0,28--1,68
Corrente nominal de serviço Mín--Máx ^(a)	A	1,33--6,02	1,34--7,32
COP (coeficiente de desempenho) Máx--Mín ^(a)	/	12,32--7,12	11,51--7,10
Capacidade de aquecimento Mín--Máx ^(b)	kW	1,71--7,60	2,70--9,70
Potência elétrica absorvida Mín--Máx ^(b)	kW	0,27--1,49	0,44--1,88
COP (coeficiente de desempenho) Máx--Mín ^(b)	/	6,40--5,1	6,10--5,55
Corrente máxima de serviço (CMS)	A	7,30	8,90
Calibre do fusível	aM	8	10
Disjuntor curva D	D	8	10
Corrente de arranque	A	< CMS	< CMS
Ligação hidráulica	mm	50mm	
Caudal de água nominal ^(a)	m ³ /h	4,20	5,10
Perda de carga na água máx	kPa	3,3	4,5
Compressor	/	DC Inverter Mitsubishi	DC Inverter Highly
Tipo	/	Duplo Rotativo	Duplo Rotativo
Quantidade	/	1	
Resistência de enrolamento a 20°C	Ohm	1,91	0,788
Ventilador	/	Axial	
Quantidade	/	1	
Diâmetro	mm	405	510
Número de pás	/	3	
Motor	/	DC Inverter	
Quantidade	/	1	1
Velocidade de rotação	Rpm	500--700	500-650
Velocidade Modo Silêncio	Rpm	300	400
Nível de pressão acústica a 1 m	dB(A)	33--41	33-41
Nível de pressão acústica a 10m	dB(A)	16--25	16--25
Dimensões (sem embalagem) da unidade (C-L-A)	mm	1046/400/768	
Peso	kg	53	65



(a) Ar seco 27°C - Humidade relativa 78% - Temperatura de entrada da água 26°C.

(b) Ar seco 15°C - Humidade relativa 71% - Temperatura de entrada da água 26°C

2. CARACTERÍSTICAS TÉCNICAS (continuação)

2.2 Período de funcionamento

Utilizar a bomba de aquecimento nos seguintes intervalos de temperatura e humidade para assegurar um funcionamento seguro e eficaz.

	Modo de aquecimento 	Modo de Refrigeração 
Temperatura exterior	-12°C – +35°C	+7°C – +43°C
Temperatura da água	+12°C – +40°C	+8°C – +40°C
Humidade relativa	< 80%	< 80%
Intervalo de Ajuste do ponto de afinação	+15°C – +32°C	+8°C – +32°C



Se a temperatura e a humidade não corresponderem a estas condições, podem disparar os dispositivos de segurança e a bomba de aquecimento pode deixar de funcionar.



A temperatura máxima de aquecimento é limitada à 32°C a fim de evitar a deterioração dos liners. Hayward declina qualquer responsabilidades em caso de utilização que ultrapassa os +32°C.

2. CARACTERÍSTICAS TÉCNICAS (continuação)

2.3 Dimensões

Modelos:

ENPI4M / ENPI6M

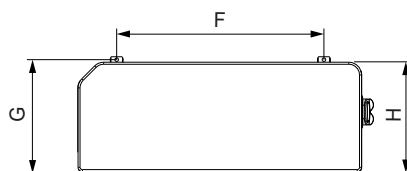
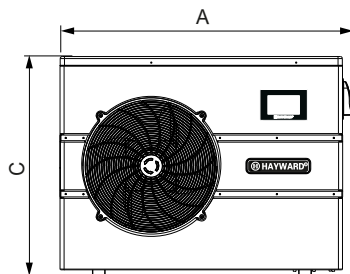
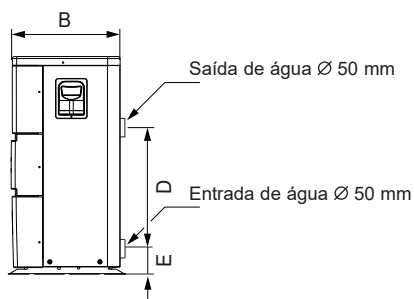

unidade : mm

Referência \ TIPO	ENPI4M / ENPI6M
A	1046
B	400
C	768
D	350
E	110
F	615
G	428
H	400

3. INSTALAÇÃO E LIGAÇÃO

3.1 Esquema de princípio

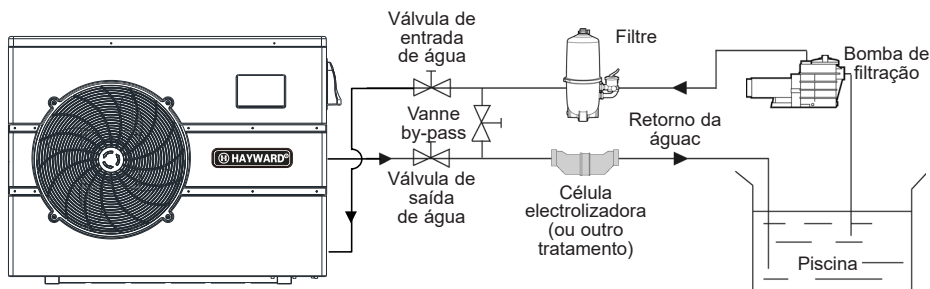

Nota: A bomba de aquecimento é fornecida sem qualquer equipamento de tratamento ou filtração. Os elementos presentes no esquema são peças a fornecer pelo instalador.

3.2 Bomba de aquecimento



Colocar a bomba de aquecimento no exterior e fora de qualquer local técnico fechado.

Colocada sob abrigo, devem ser respeitadas as distâncias mínimas prescritas abaixo a fim de evitar qualquer risco de recirculação de ar e de degradação dos desempenhos globais da bomba de aquecimento.

Unidade : mm

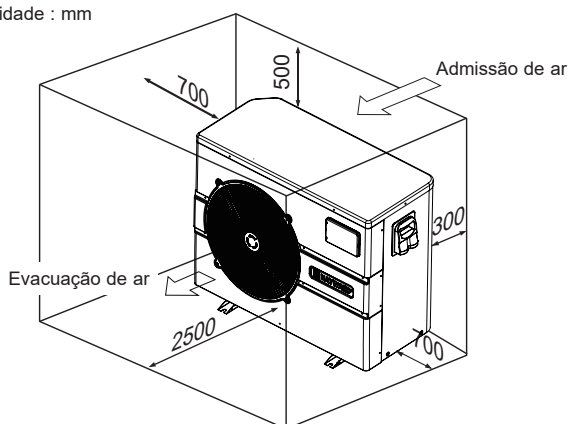

3. INSTALAÇÃO E LIGAÇÃO (continuação)



Instalar de preferência a bomba de calor sobre uma laje de betão dessolidarizada ou uma caixa de fixação prevista para este efeito e montar a bomba de aquecimento sobre os blocos amortecedores fornecidos (parafusos e anilhas não fornecidos).

Distância máxima de instalação entre a bomba de aquecimento e a piscina 15 metros.

Comprimento total ida e volta das canalizações hidráulicas 30 metros.

Isolar as canalizações hidráulicas de superfície e enterradas.

A bomba de calor deve ser instalada a uma distância mínima da piscina de acordo com a norma NF C 15-100 (ou seja, a 3,5 m da massa de água, em França) ou com as normas de instalação em vigor noutros países.

Não instalar a bomba de calor junto a fontes de calor.

Em caso de instalação em regiões com ocorrência de neve, recomenda-se manter a máquina abrigada para evitar a acumulação de neve no evaporador.

3.3 Ligação hidráulica

A bomba de aquecimento é fornecida com duas uniões de 50 mm de diâmetro. Utilizar tubo PVC para canalização hidráulica Ø 50 mm. Ligar a entrada de água da bomba de aquecimento à conduta proveniente do grupo de filtração e, em seguida, ligar a saída de água da bomba de aquecimento à conduta de água que segue para a bacia (consultar esquema abaixo).

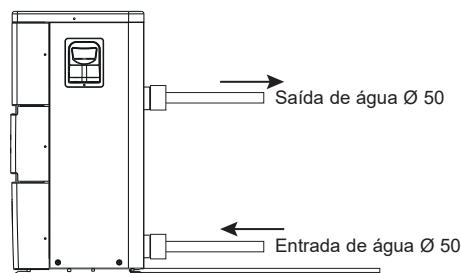

Instalar uma válvula dita de “by-pass” entre a entrada e a saída da bomba de aquecimento.



Se for utilizado um distribuidor automático, deve obrigatoriamente ser instalado após a bomba de aquecimento a fim de proteger o condensador Titane contra uma concentração demasiado elevada de produto químico.



Tenha o cuidado de instalar a bomba de by-pass e as uniões fornecidas ao nível de entrada e saída de água da unidade, a fim de simplificar a purga durante o período de Inverno, facilitar o acesso ou a respectiva desmontagem para manutenção.

3. INSTALAÇÃO E LIGAÇÃO (continuação)

3.4 Ligação eléctrica



A instalação eléctrica e a cablagem deste equipamento devem estar em conformidade com a regras de instalação locais em vigor.

F	NF C15-100	GB	BS7671:1992
D	DIN VDE 0100-702	EW	EVHS-HD 384-7-702
A	ÖVE 8001-4-702	H	MSZ 2364-702/1994/MSZ 10-553 1/1990
E	UNE 20460-7-702 1993, RECBT ITC-BT-31 2002	M	MSA HD 384-7-702.S2
IRL	Regras de cablagem + IS HD 384-7-702	PL	PN-IEC 60364-7-702:1999
I	CEI 64-8/7	CZ	CSN 33 2000 7-702
LUX	384-7.702 S2	SK	STN 33 2000-7-702
NL	NEN 1010-7-702	SLO	SIST HD 384-7-702.S2
P	RSIUEE	TR	TS IEC 60364-7-702



Verifique que a alimentação eléctrica disponível e a frequência da rede correspondem à corrente de funcionamento requerida, tendo em conta a localização específica do equipamento, e a corrente necessária para alimentar qualquer outro aparelho ligado ao mesmo circuito.

ENPI4M 230V \sim +/- 10 % 50 Hz 1 Fase

ENPI6M 230V \sim +/- 10 % 50 Hz 1 Fase

Observe o esquema de cablagem correspondente em anexo.

A caixa de ligações encontra-se do lado direito da unidade. Três ligações destinam-se à alimentação eléctrica, e duas ao comando da bomba de filtração (Servocomando).

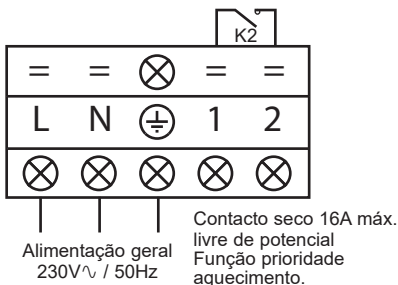

3. INSTALAÇÃO E LIGAÇÃO (continuação)



A linha de alimentação eléctrica deve ser dotada, de maneira apropriada, de um dispositivo de protecção fusível do tipo alimentação de motor (aM) ou disjuntor curvo D bem como de um disjuntor diferencial de 30mA (ver tabela anexa).

Modelos		ENPI4M	ENPI6M
Alimentação eléctrica	V/Ph/Hz	230V~ 50Hz	230V~ 50Hz
Calibre fusível tipo aM	A	8 aM	10 aM
Disjuntor curvo D	A	8 D	10 D
Secção de cabo	mm ²	3G 2,5	3G 2,5



Utilizar o cabo de alimentação do tipo RO 2V / R 2V ou equivalente.



As secções de cabo são fornecidas para um comprimento máximo de 25 m. Devem no entanto ser verificadas e adaptadas em função das condições de instalação.



Tenha sempre o cuidado de interromper a alimentação principal antes de abrir a caixa de comando eléctrico.

3.5 Primeira colocação em serviço

Procedimento de arranque - uma vez a instalação terminada, seguir e respeitar as etapas seguintes:

- 1) Faça girar os ventiladores com a mão a fim de verificar que ele pode girar livremente com a mão, e que a hélice está fixada correctamente sobre o eixo do motor.
- 2) Assegure-se que a unidade está correctamente ligada à alimentação principal (ver esquema de cablagem em anexo).
- 3) Active a bomba de filtração.
- 4) Verifique que todas as válvulas de água estão abertas, e que a água flui para a unidade antes de passar ao modo de aquecimento ou refrigeração.
- 5) Verifique que o tubo de purga de condensados está correctamente fixado e não apresenta nenhuma obstrução.
- 6) Active a alimentação eléctrica destinada à unidade, depois prima a tecla Marche/Arrêt (Marcha/Paragem)  no painel de comando.

3. INSTALAÇÃO E LIGAÇÃO (continuação)

- 7) Verifique se, ao ligar, o símbolo de alarme (Δ) não está vermelho. Se for o caso, consulte o guia de resolução de problemas (consulte a secção 6.4).
- 8) Fixe o débito de água com a ajuda da válvula de by-pass (ver § 3.6 e 2.1), conforme previsto respectivamente para cada modelo, de modo a obter uma diferença de temperatura Entrada/Sáida de 2°C.
- 9) Após um funcionamento de alguns minutos, verifique que o ar que sai da unidade é refrigerado (entre 5 e 10°).
- 10) Com a unidade em serviço, desactive a bomba de filtração. A unidade deve parar automaticamente e apresentar o código de erro E03.
- 11) Faça funcionar a unidade e a bomba da piscina 24 horas sobre 24, até que seja atingida a temperatura da água pretendida. Quando a temperatura de entrada de água atingir o valor de afinação, a unidade pára. Volta então a arrancar automaticamente (desde que a bomba da piscina esteja em serviço) se a temperatura da piscina for inferior em pelo menos 0,5°C à temperatura regulada.

Controlador de débito - A unidade é dotada de um controlador de débito que activa a bomba de calor quando a bomba de filtração da piscina está em serviço, e desactiva-a quando a bomba de filtração está fora de serviço. Por falta de água, aparece no regulador o código de alarme E03 (Ver § 6.4).

Temporização - a unidade integra uma temporização de 3 minutos, a fim de proteger os componentes do circuito de comando, eliminar qualquer instabilidade em termos de re-arranque e qualquer interferência ao nível do contactor. Graças a esta temporização, a unidade voltar a arrancar automaticamente cerca de 3 minutos após qualquer corte do circuito de comando. Mesmo um corte de corrente de curta duração activa a temporização de arranque.

3. INSTALAÇÃO E LIGAÇÃO (continuação)

3.6 Ajuste do débito de água

Com as válvulas de entrada e saída de água abertas, ajustar a válvula de “by-pass” de modo a obter uma diferença de 2°C entre a temperatura de entrada e saída de água (ver esquema de princípio § 3.1). Pode verificar a Ajuste visualizando as temperaturas de entrada/saída directamente no painel de comando.



Nota: A abertura da válvula de “by-pass” provoca um débito menor, logo um aumento da ΔT .

O fecho da válvula de “by-pass” provoca um débito maior, logo uma diminuição da ΔT .

4. INTERFACE DO UTILIZADOR

4.1 Apresentação geral

A bomba de aquecimento está equipada com um painel de comando digital com ecrã táctil, ligado electricamente e pré-regulado de fábrica em modo de aquecimento.



Legenda

1		Alarme (vermelho intermitente)	10b		Modo aquecimento
2		Ecrã bloqueado	10c		Modo automático
3		Data	11		Saída de água
4		Hora	12		Seleção do modo silêncio
5		Temperatura exterior	12a		Configurar temporizador do modo silêncio
6		Base de registo (Temperatura da água e potência absorvida)	12b		Indicador do modo silêncio e activação
7		Leitura e registo dos parâmetros	13		Conversão °C/°F
8		Deslocamento para cima/Aumentar	14		Température Entrée d'eau
9		Deslocamento para baixo/Diminuir	15		Configuração de data e hora Temporizador ON/OFF
10		Seleção do modo de funcionamento	16		Descongelamento em curso
10a		Mode arrefecimento	17		Marcha/Paragem

4. INTERFACE DO UTILIZADOR (continuação)

Modo OFF (desligado)

Quando a bomba de aquecimento está em espera (Modo OFF), o botão  está acinzentado.

Modo ON (ligado)

Quando a bomba de aquecimento está em funcionamento ou em Ajuste (Modo ON), ao acender, o botão  está verde.

4.2 Configuração de data e hora



Voltar ao ecrã anterior

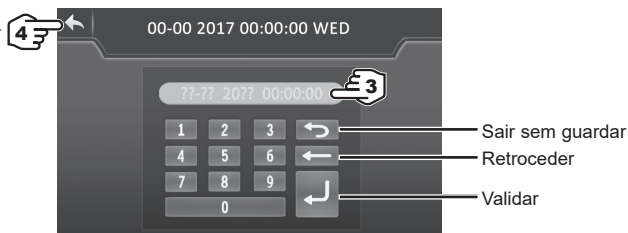

Preencher todos os campos (Dia/Mês/Ano, Hora/Minuto/Segundo) antes de validar. Caso contrário, as alterações não serão guardadas.

4.3 Ajuste da função Timer (temporizador)

O ajuste desta função é necessária caso pretenda fazer funcionar a bomba de aquecimento por um período mais curto que o definido pelo relógio de filtração. Pode assim programar um arranque diferido e um arranque antecipado ou simplesmente impedir um intervalo horário de funcionamento (por exemplo a noite).

É possível programar 1 Timer de Arranque e 1 Timer de Paragem.

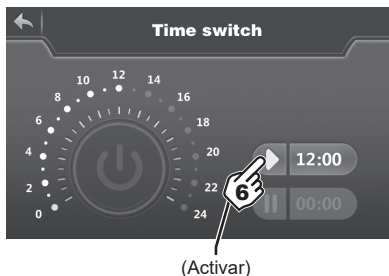
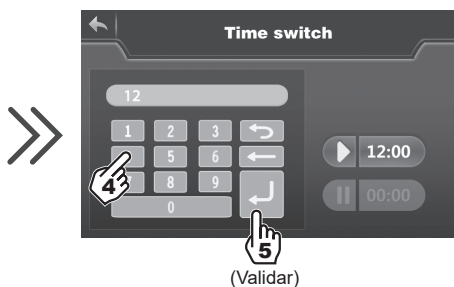
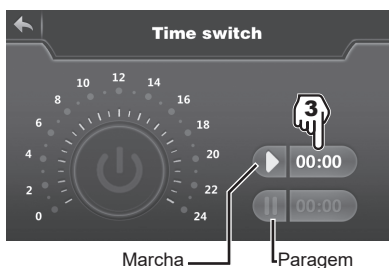
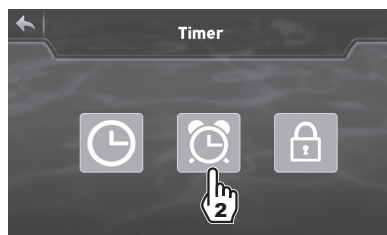

4. INTERFACE DO UTILIZADOR (continuação)



Azulado = Activado
Acinzentado = Desactivado



O ciclo de configuração é "de hora a hora".



- Uma vez que a hora de início está configurada, premir  (passo 6) para activar o Temporizador. O símbolo e a hora ficam com uma cor azulada.
- Repetir os passos 3 a 6 para configurar e activar a hora de paragem ( 00:00).
- Depois de configurar, a placa de funcionamento da bomba de calor fica com uma cor esverdeada e a placa de paragem fica com uma cor amarelada.
- Premir  2 vezes para voltar ao ecrã principal.

4. INTERFACE DO UTILIZADOR (continuação)

4.4 Ajuste e visualização do ponto de ajuste



Em Modo “OFF” ou Modo “ON”

Premir  para visualizar o ponto de ajuste ; depois premir  ou  para definir o ponto de ajuste pretendido.

Premir  para validar. Retrocederá automaticamente para o ecrã principal,



O ajuste efectua-se com uma precisão de 0,5 °C



É recomendável nunca ultrapassar a temperatura de 30°C para evitar a alteração das juntas.

4. INTERFACE DO UTILIZADOR (continuação)



4.5 Bloqueio e libertação do ecrã táctil

O ecrã de controlo fica bloqueado automaticamente ao fim de um minuto (por predefinição).

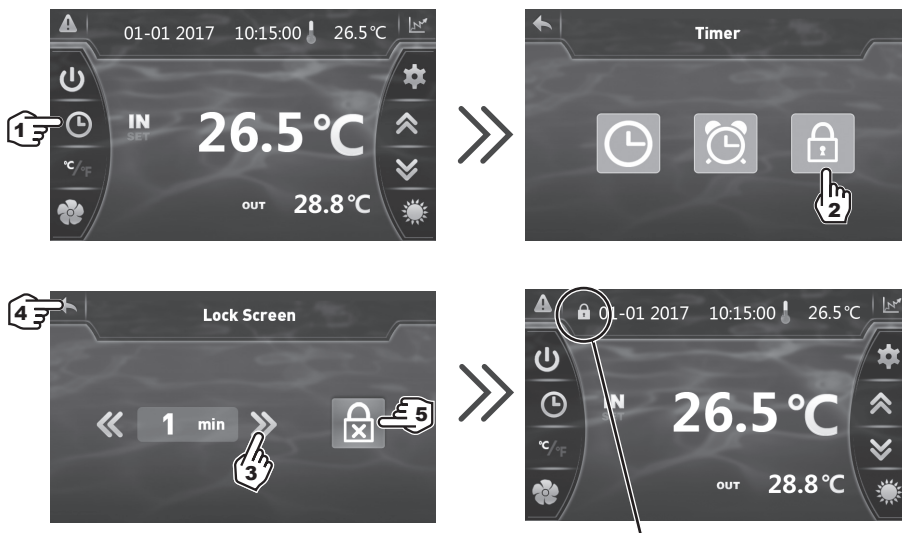
É possível ajustar o período de tempo (entre 1 a 10 minutos) antes de o ecrã ficar automaticamente bloqueado, bem como desactivar simplesmente esta opção.



Bloqueio automático activado

- 3) Seleccionar um período entre 1 e 10 minutos. A alteração é guardada automaticamente.
- 4) Premir  2 vezes para voltar ao ecrã principal.
- 5) Premir  para desactivar o bloqueio automático.

Para desbloquear o ecrã, premir qualquer local no ecrã durante 2 segundos. Introduzir o código “22” e validar, premindo **EN**



4. INTERFACE DO UTILIZADOR (continuação)

4.6 Ajustamento do modo SILÊNCIO

O modo silêncio permite utilizar a bomba de calor em modo económico e muito silencioso quando as necessidades de aquecimento são baixas (manter a temperatura da piscina ou assegurar o funcionamento ultra silencioso). Esta função pode ser Activada/Desactivada manualmente ou usando um temporizador.

Activação Manual



Modo silêncio activado

4. INTERFACE DO UTILIZADOR (continuação)

Desactivação Manual



Modo silêncio desactivado

Configurar o temporizador

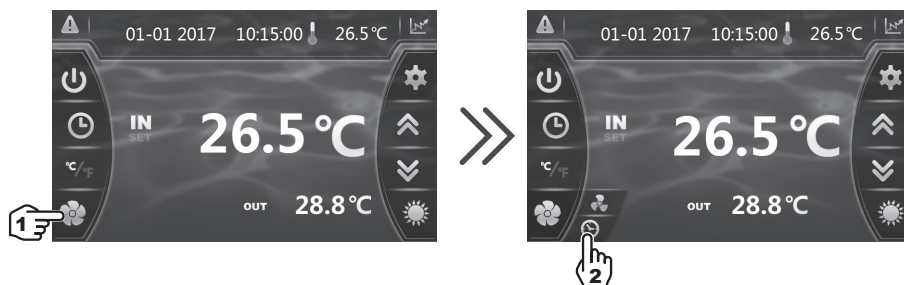

4. INTERFACE DO UTILIZADOR (continuação)

Configurar o temporizador (cont.)

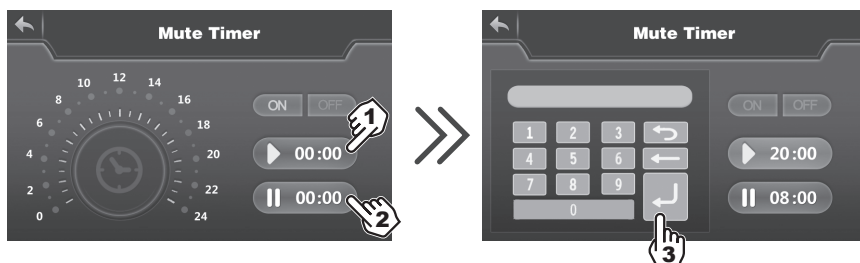

- 1) Hora de início, introdução e validação.
- 2) Hora de fim, introdução e validação.
- 3) Validar.

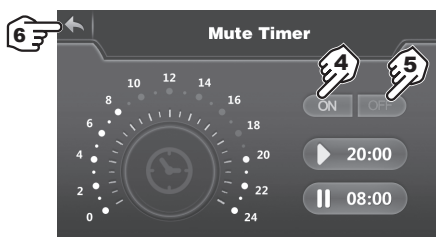

- 4) Activação.
- 5) Desactivação.
- 6) Voltar ao ecrã principal.



O ciclo de configuração é "de hora a hora".

Depois de o activar, o temporizador fica activo 24 horas por dia.

5. MANUTENÇÃO E PREPARAÇÃO PARA O INVERNO

5.1 Manutenção

Estas operações de manutenção devem ser realizadas 1 vez por ano a fim de garantir a longevidade e o bom funcionamento da bomba de aquecimento.

- Limpar o evaporador com a ajuda de uma escova macia ou jacto de ar ou água (**Atenção, nunca utilizar um aspersor de alta pressão**).
- Verificar o bom escoamento dos condensados.
- Verificar o aperto das ligações hidráulicas e eléctricas
- Verificar a estanqueidade hidráulica do condensador.
- **Solicitar a um profissional** com formação que verifique a impermeabilidade do circuito frigorífico através do detetor de fugas.



Antes de qualquer operação de manutenção a bomba de aquecimento deve ser desligada de qualquer fonte de corrente eléctrica. As operações de manutenção devem ser realizadas unicamente por pessoal qualificado e habilitado para manipular fluidos de refrigeração.

5.2 Preparação para o Inverno

- Colocar a bomba de aquecimento em Modo “OFF”.
- Cortar a alimentação da bomba de aquecimento.
- Esvaziar o condensador com a ajuda do dreno para evitar qualquer risco de degradação. (risco importante de congelação).
- Fechar a válvula de “by-pass” e desapertar as uniões de entrada/saída.
- Expulsar ao máximo a água residual do condensador com a ajuda de uma pistola de ar.
- Obturar a entrada e a saída de água na bomba de aquecimento para evitar a entrada de corpos estranhos.
- Cobrir a bomba de aquecimento com a capa de Inverno prevista para este efeito.



Qualquer dano ocasionado por deficiente preparação para o Inverno implica a anulação da garantia.

6. ANEXOS

6.1 Esquemas eléctricos

ENPI4M

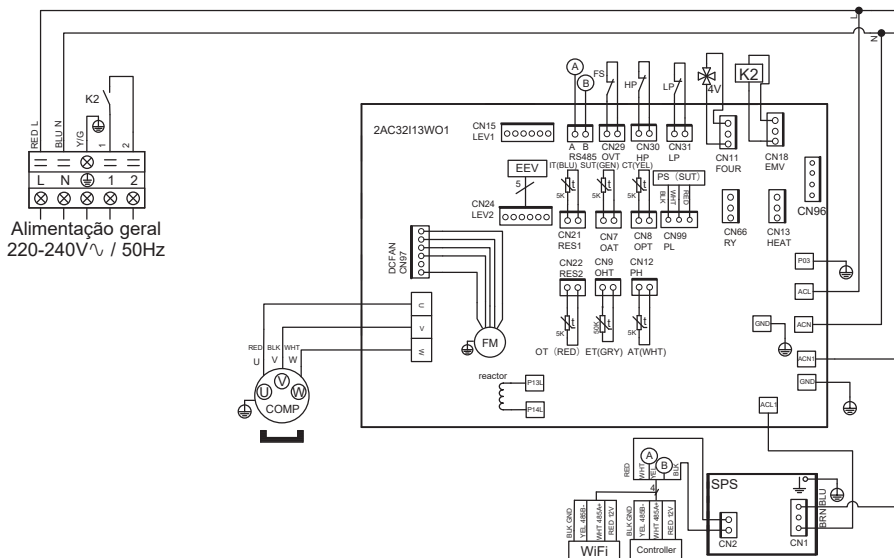

LEGENDA

- AT : SONDA DE TEMPERATURA DO AR
- COMP : COMPRESSOR
- CT : SONDA TEMPERATURA EVAPORADOR
- EEV : REGULADOR ELECTRÓNICO
- FM : MOTOR VENTILADOR
- FS : DETECTOR PRESENÇA DE ÁGUA
- HP : PRESSÓSTATO ALTA PRESSÃO
- IT : SONDA DE TEMPERATURA ENTRADA DE ÁGUA

- LP : PRESSÓSTATO BAIXA PRESSÃO
- OT : SONDA DE TEMPERATURA SAÍDA DE ÁGUA
- SUT : SONDA DE TEMPERATURA DE ASPIRAÇÃO
- 4V : VÁLVULA DE 4 VIAS
- ET : SONDA DE TEMPERATURA DE DESCARGA
- PS : SENSOR DE PRESSÃO

6. ANEXOS (continuação)

ENPI6M

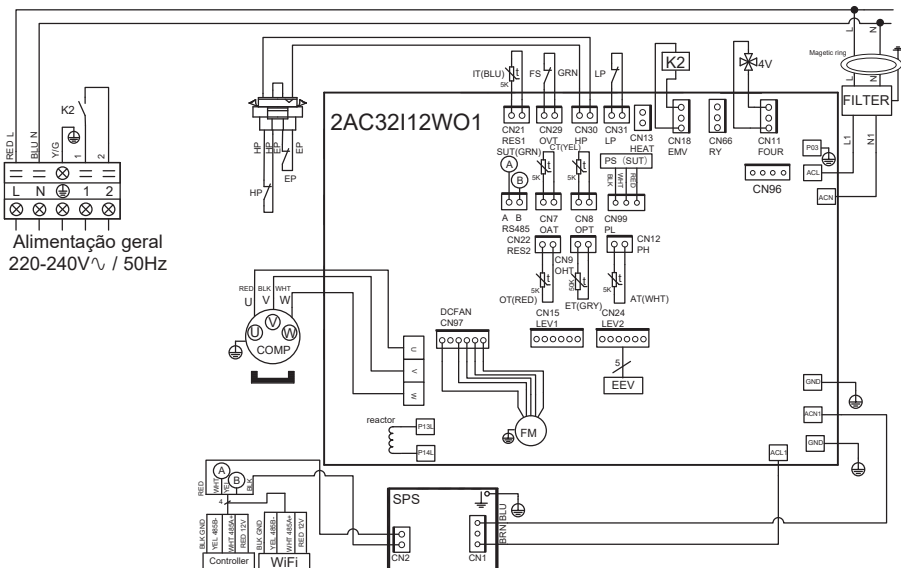

LEGENDA

- | | |
|--|--|
| AT : SONDA DE TEMPERATURA DO AR | LP : PRESSÓSTATO BAIXA PRESSÃO |
| COMP : COMPRESSOR | OT : SONDA DE TEMPERATURA SAÍDA DE ÁGUA |
| CT : SONDA TEMPERATURA EVAPORADOR | SUT : SONDA DE TEMPERATURA DE ASPIRAÇÃO |
| EEV : REGULADOR ELECTRÓNICO | 4V : VÁLVULA DE 4 VIAS |
| FM : MOTOR VENTILADOR | K2 : CONTACTO SECO LIVRE DE POTENCIAL 16A MÁX |
| FS : DETECTOR PRESENÇA DE ÁGUA | ET : SONDA DE TEMPERATURA DE DESCARGA |
| HP : PRESSÓSTATO ALTA PRESSÃO | PS : SENSOR DE PRESSÃO |
| IT : SONDA DE TEMPERATURA ENTRADA DE ÁGUA | |

6. ANEXOS (continuação)

6.2 Ligações prioridade aquecimento bomba monofásica

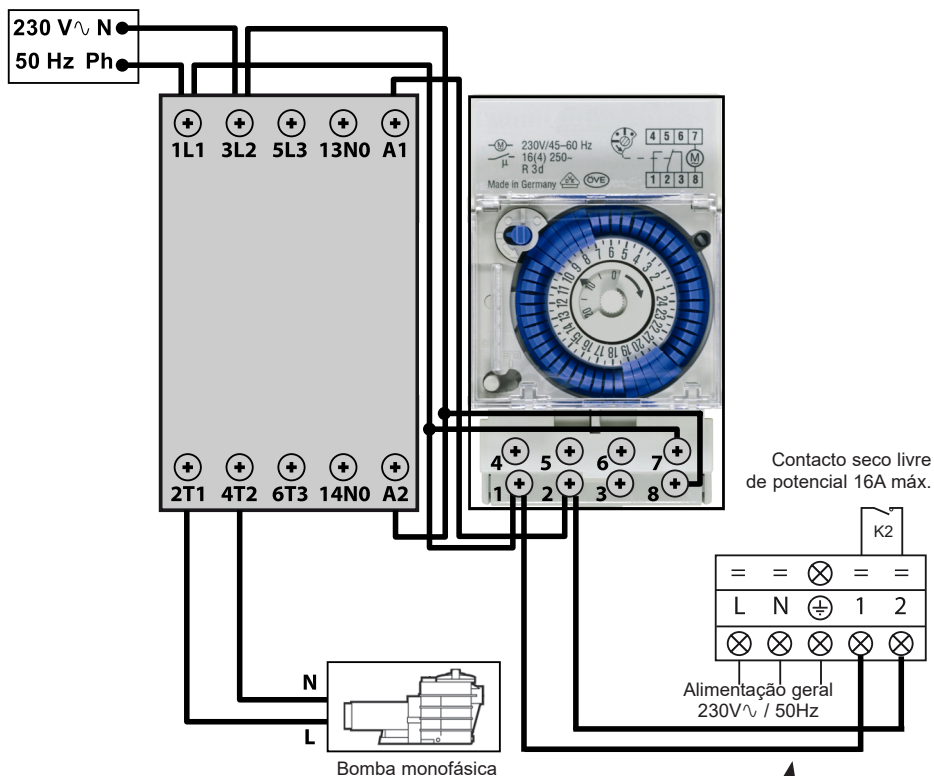

Os terminais 1 e 2 emitem um contacto seco livre de potencial, sem polaridade de 230 V \sim / 50 Hz.

Cablar os terminais 1 e 2 respeitando a cablagem indicada acima, a fim de controlar o funcionamento da bomba de filtração por ciclo de 2 minutos todas as horas se a temperatura da bacia for inferior ao ponto recomendado.

 Nunca conecte a alimentação da bomba de filtração directamente sobre os terminais 1 e 2.



Página deixada em branco intencionalmente

6. ANEXOS (continuação)

6.3 Vistas explodidas e peças sobressalentes

ENPI4M / ENPI6M

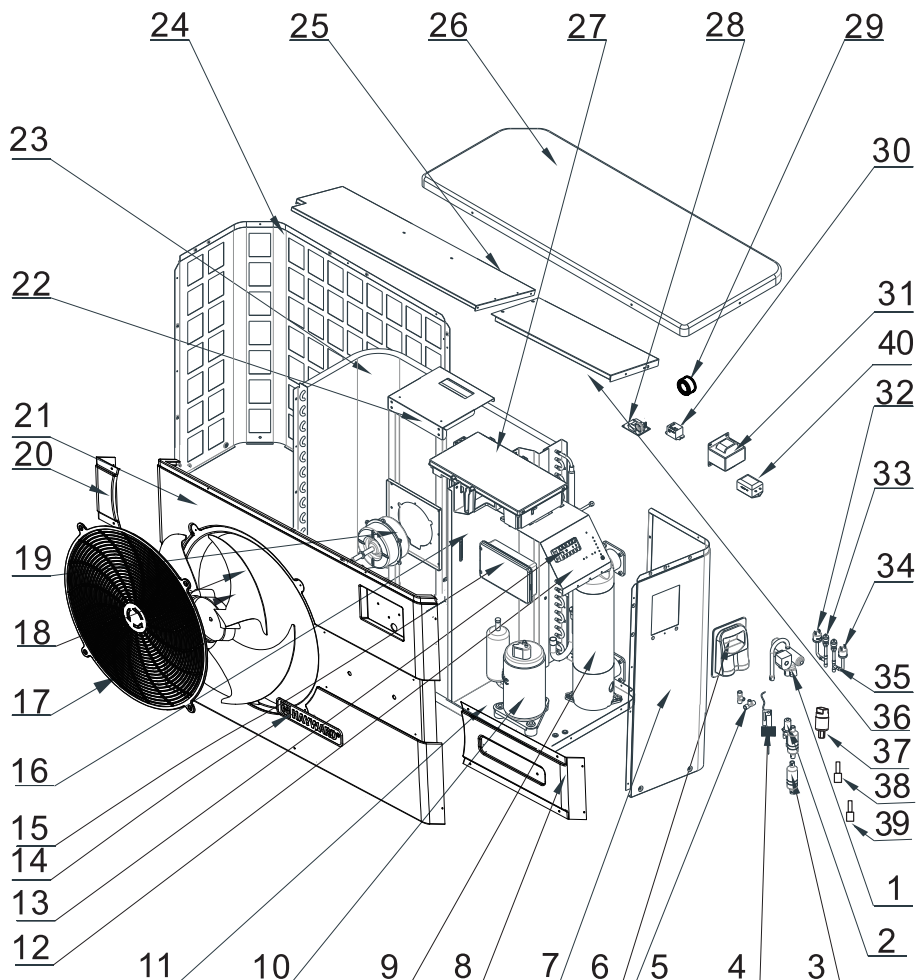

6. ANEXOS (continuação)

ENPI4M / ENPI6M

Rep	Ref.	Designação	ENPI4M	ENPI6M
1	Válvula de 4 vias	HWX20041437	✓	✓
2	Regulador electrónico	HWX81000015	✓	n/a
		HWX81000016	n/a	✓
3	Filtro ø9.7-ø9.7 (Ø28)	HWX20041444	✓	✓
4	Detector de débito de água	HWX83000012	✓	✓
5	Conector T ø9.52-2 x ø6.5(T) x 1.0	HWX304030000002	✓	✓
6	Alçapão de acesso eléctrico	HWX320922029	✓	✓
7	Painel direito	HWX80700455	✓	✓
8	Painel decorativo direito	HWX80900089	✓	✓
9	Condensador Titânio/PVC	HWX80600074	✓	n/a
		HWX80600096	n/a	✓
10	Compressor	HWX20000110448	✓	n/a
		HWX80100003	n/a	✓
11	/	/	/	/
12	/	/	/	/
13	Terminal L-N-GND -5 ligações 4mm ²	HWX40003901	✓	✓
14	Logotipo HAYWARD	HWX20000230596	✓	✓
15	Ecrã táctil colorido	HWX95005310612	✓	✓
16	/	/	/	/
17	Grelha de protecção do ventilador	HWX20000220169	✓	✓
18	Hélice ventilador	HWX20000270004	✓	✓
19	Motor do ventilador DC	HWX20000330132	✓	✓
20	Painel decorativo esquerdo	HWX80900088	✓	✓
21	Painel ABS dianteiro	HWX80900087	✓	✓
22	Suporte do motor	HWX80700248	✓	✓
23	Evaporador de alheta	HWX80600044	✓	n/a
		HWX80600100	n/a	✓
24	Painel esquerdo	HWX80700455	✓	✓
25	/	/	/	/
26	Painel superior	HWX301090200806	✓	✓
27	Placa electrónica Driver	HWX82300008	✓	n/a
		HWX82300007	n/a	✓
28	Transformador 230 V~/12 VDC	HWX82600008	✓	✓
29	/	/	/	/
30	Relés K2	HWX20000360297	✓	✓
31	Bobina 20A 50Hz 5mH	HWX82500005	✓	✓
32	Pressóstato de baixa pressão NO 0.30MPa/0.15MPa	HWX20000360157	✓	✓
33	Medição da pressão 40 mm 1/2"	HWX20000140150	✓	✓
34	Pressóstato de alta pressão NC 3.2MPa/4.4MPa	HWX20013605	✓	✓
35	Conector T ø6.5-2 x ø6.5(T) x 0.75T2M	HWX20001460	✓	✓
36	/	/	/	/
37	Sensor de pressão	HWX20000360123	✓	✓
38	Sonda de descarga compressor 50 kΩ-660mm	HWX83000026	✓	✓
	Sonda temperatura de ar 5k-350mm	HWX83000049	✓	✓
	Sonda de saída de água 5k-410mm	HWX83000050	✓	✓
39	Sonda de entrada de água 5k-850mm	HWX83000052	✓	✓
	Sonda de aspiração compressor 5k-560mm	HWX83000044	✓	✓
	Sonda descongelação 5k-680mm	HWX83000051	✓	✓
40	Filtro EMC	HWX20003257	n/a	✓

6. ANEXOS (continuação)

6.4 Guia de resolução de avarias



Certas operações devem ser realizadas por um técnico habilitado.

Em caso de defeito na bomba de calor, o símbolo  fica vermelho e a piscar no canto esquerdo do ecrã.

Premir o símbolo  para abrir a lista de erros.

Em caso de falha, as indicações seguintes aparecem no ecrã:

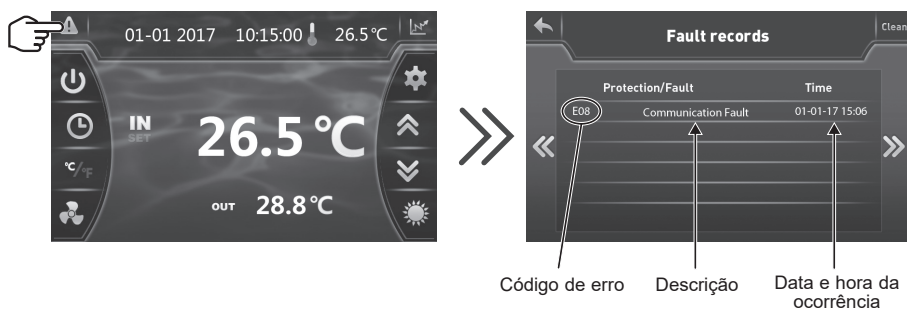

Após a resolução do problema, o erro é apagado automaticamente e o triângulo volta a ficar cinzento.



Para apagar a lista de erros, premir **Clean e, em seguida, premir  para voltar ao ecrã anterior.**

6. ANEXOS (continuação)

Avaria	Códigos de erro	Descrição	Solução
Avaria sonda de entrada de água	P01	O sensor está aberto ou apresenta curto-circuito.	Verificar os conetores CN21/RES1 na placa e o conetor de extensão ou substituir o sensor
Avaria sonda de saída de água	P02		Verificar os conetores N22/RES2 na placa e o conetor de extensão ou substituir o sensor
Avaria sonda temperatura exterior	P04		Verificar os conetores CN12/PH na placa e o conetor de extensão ou substituir o sensor
Avaria sonda descongelação	P05		Verificar os conetores CN8/OPT na placa e o conetor de extensão ou substituir o sensor
Defeito sonda de aspiração compressor	P07		Verificar os conetores CN7/OAT na placa e o conetor de extensão ou substituir o sensor
Defeito sonda de descarga compressor	P081		Verificar os conetores CN9/OHT na placa e o conetor de extensão ou substituir o sensor
Protecção de alta pressão	E01	O sensor está aberto ou apresenta curto-circuito.	Verificar os conetores CN30/HP no mapa ou substituir o sensor
			Verificar o caudal de água
			Verificar o detector de caudal de água
			Verificar a abertura das válvulas
			Verificar o by-pass
			Verificar a sujidade do evaporador
			Temperatura da água muito elevada
			Problema de gás não condensável após manutenção, fechar e retirar o vácuo do circuito frigorífico
Carga de fluido muito elevada, retirar fluido com uma garrafa			
Protecção de baixa pressão	E02	O sensor está aberto ou apresenta curto-circuito.	Verificar a ligação AI/DI03 no mapa ou substituir o sensor
			Fuga grave de fluido de refrigeração, procurar uma fuga com o detector
			Fluxo de ar muito fraco, verificar a velocidade de rotação do ventilador
			Verificar a sujidade do evaporador, limpar a superfície
Avaria detector de débito	E03	O sensor está aberto ou apresenta curto-circuito.	Verificar a ligação AI/DI02 no mapa ou substituir o sensor
			Falta de água, verificar o funcionamento da bomba de filtração
			Verificar a abertura das válvulas de paragem
			Verificar a configuração do by-pass

6. ANEXOS (continuação)

Avaria	Códigos de erro	Descrição	Solução
Diferença de temperatura entrada/saída > 13 °C	E06	Aplicável apenas no modo Frio	Falta de água, verificar o funcionamento da bomba de filtração
			Verificar a abertura das válvulas de paragem
			Verificar a configuração do by-pass
Protecção Antigelo	E07	Temperatura de saída da água < 4 °C	Parar a bomba de calor, esvaziar o condensador, risco de congelamento
Problema de comunicação	E08	Não há nenhuma comunicação entre a placa eletrónica e a interface do utilizador	Verificar as ligações e os conectores - ver esquema elétrico
Protecção antigelo de nível 1	E19	2 °C < Temperatura da água < 4 °C e Temperatura do ar < 0 °C	Interromper o funcionamento da bomba de calor, esvaziar o condensador para evitar o congelamento. Por defeito, a bomba de calor inicia a bomba de filtração e a bomba de calor para evitar a entrada de gelo.
Protecção antigelo de nível 2	E29	Temperatura da água < 2 °C e Temperatura do ar < 0 °C	Interromper o funcionamento da bomba de calor, esvaziar o condensador para evitar o congelamento. Por defeito, a bomba de calor inicia a bomba de filtração e a bomba de calor para evitar a entrada de gelo.
Defeito do motor ventilador	F031	Motor bloqueado ou defeito de ligação	Verificar a sua livre rotação; verificar os conectores CN97/DCFan; substituir o motor
Defeito do motor ventilador	F051	Defeito de ligação	Verificar os conectores DCFAN/CN97; substituir o motor
Temperatura exterior demasiado baixa	TP	Limite de funcionamento atingido	Parar a bomba de calor
Defeito sensor de pressão	PP	O sensor está aberto ou em curto circuito	lcar a ligação (ver o esquema eléctrico)

6. ANEXOS (continuação)

6.5 Base de registo

No ecrã principal, premir  para abrir o histórico dos registos das temperaturas de entrada e de saída da água.

Premir  para verificar a potência eléctrica média consumida.



Estes dados estão disponíveis durante 60 dias.

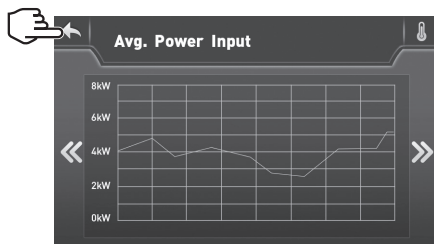
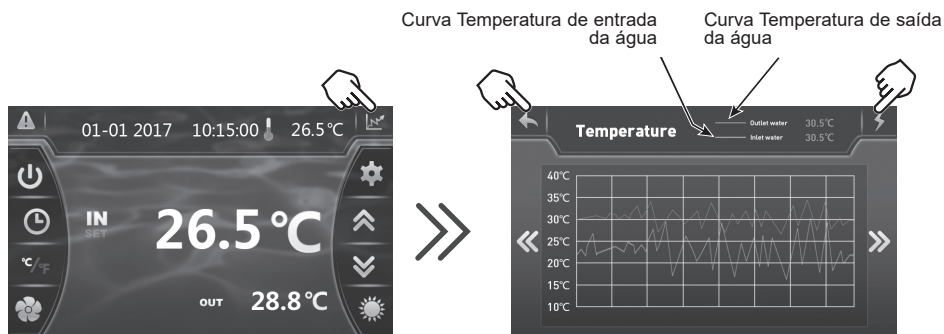

Premir  para voltar ao ecrã principal.

6. ANEXOS (continuação)

6.6 Garantia

CONDIÇÕES DE GARANTIA

Todos os produtos HAYWARD são garantidos contra todos os defeitos de fabrico ou de matéria-prima durante um período de dois anos a contar da data de aquisição. Qualquer reclamação de garantia deverá ser acompanhada de uma prova de compra contendo a data. Recomendamos, assim, que conserve a sua factura.

A garantia HAYWARD é limitada à reparação ou substituição, por opção da HAYWARD, dos produtos defeituosos desde que tenham sido submetidos a uma utilização normal, em conformidade com as prescrições mencionadas no respectivo manual de utilização, que o produto não tenha sido modificado de nenhuma forma e tenha sido utilizado unicamente com componentes e peças da HAYWARD. Os danos devidos ao gelo e aos ataques de agentes químicos não são garantidos. Todas as outras despesas (transporte, mão-de-obra...) estão excluídas da garantia.

A HAYWARD não poderá ser considerada responsável por qualquer dano directo ou indirecto proveniente da instalação, da ligação ou do funcionamento incorrecto do produto.

Para fazer aplicar uma garantia ou solicitar a reparação ou substituição de um artigo, dirija-se ao seu revendedor. Não será aceite qualquer devolução de material à nossa fábrica sem o nosso acordo prévio por escrito. As peças de desgaste não se encontram cobertas pela garantia.

ISENPINVR32

ENERGYLINE PRO INVERTER

HEIZPUMPENANLAGE FÜR EIN SCHWIMMBECKEN



Einbau- & Anleitungshandbuch

INHALTSVERZEICHNIS

1. VORWORT	1
2. TECHNISCHE EIGENSCHAFTEN	4
2.1 Technische Angaben zur Heizpumpenanlage	4
2.2 Betriebsbereich	5
2.3 Maße	6
3. INSTALLATION UND ANSCHLUSS	7
3.1 Schematische Darstellung	7
3.2 Heizpumpenanlage	7
3.3 Hydraulischer Anschluss	8
3.4 Elektrischer Anschluss	9
3.5 Erste Inbetriebnahme	10
3.6 Einstellung des Wasserdurchsatzes	12
4. BENUTZEROBERFLÄCHE	13
4.1 Allgemeine Darstellung	13
4.2 Einstellung Datum und Uhrzeit	14
4.3 Einstellung der Timer-Funktion	14
4.4 Einstellung und Anzeige des Sollwerts	16
4.5 Sperren und Entsperren des Touchscreen.	17
4.6 Activation et réglage du mode SILENCE	18
5. WARTUNG UND WINTERZEIT	21
5.1 Wartung	21
5.2 Winterzeit	21
6. ANHANG	22
6.1 Stromtafel	22
6.2 Vorrangige Heizanschlüsse einphasige Pumpe	24
6.3 Explosionszeichnungen und Einzelteile	26
6.4 Anleitung zur Fehlerbehebung	28
6.5 Grundlage für die Erfassung	31
6.6 Garantie	32

Aufmerksam lesen und für einen späteren Gebrauch aufzubewahren.

Dieses Dokument ist dem Eigentümer des Schwimmbeckens zu übergeben und muss von diesem an einem sicheren Ort aufbewahrt werden.

1. VORWORT

Für den Erwerb dieser Hayward Schwimmbadwärmepumpe danken wir Ihnen. Die Hayward Wärmepumpe FULL INVERTER wurde gemäß strengen Fertigungsnormen konzipiert, um den geforderten Höchstqualitätsniveaus zu genügen.

Durch die Steuerlogik FULL INVERTER erreichte Anpassung von Leistung, Stromverbrauch und Geräuschpegel an den Heizbedarf Ihres Schwimmbades werden Ihnen die Hayward Wärmepumpen außergewöhnliche Leistungen während Ihrer gesamten Badesaison bieten.



Vor Benutzung des Geräts lesen Sie dieses Handbuch aufmerksam durch.

Die Hayward Wärmepumpen sind ausschließlich zum Heizen vom Schwimmbadwasser ausgelegt, verwenden Sie diese Geräte nicht für andere Zwecke.

Dieses Handbuch enthält alle benötigten Informationen hinsichtlich Installation, Behebung von Funktionsstörungen und Wartung.

Lesen Sie dieses Handbuch aufmerksam durch, bevor Sie das Gerät öffnen oder Wartungsarbeiten am Gerät durchführen. Der Produkthersteller haftet in keinem Fall für die Verletzung eines Benutzers oder die Beschädigung des Geräts, die aus Fehlern bei der Installation, der Pannenbehebung bzw. aus einer nicht erforderlichen Wartung ergeben. Die in diesem Handbuch enthaltenen Anweisungen müssen jederzeit unbedingt beachtet werden.

Jede nicht beachtetete Empfehlung führt zum Verlust der Garantie.

1. VORWORT (Fortsetzung)



Sicherheitsanweisungen



Dieses Gerät enthält R32.

Verwenden Sie niemals ein anderes Kältemittel als R32. Jeder andere gasförmiger Körper, der mit dem R32 gemischt wird, kann unnormal hohe Druckwerte verursachen, die eine Panne oder einen Rohrbruch und Personenverletzungen verursachen können.

Verwenden Sie bei Reparaturen oder Wartungsarbeiten niemals Kupferrohre mit einer Wandstärke von weniger als 0,8 mm.

Da die Wärmepumpe unter Druck steht, bohren Sie niemals die Rohrleitungen und versuchen Sie auch nicht diese zu löten. Es besteht Explosionsgefahr.

Setzen Sie niemals das Gerät Flammen, Funken oder anderen Entzündungsquellen aus. Das Gerät könnte explodieren und schwere oder sogar tödliche Verletzungen verursachen.

- Zur Lagerung muss die Wärmepumpe in einem gut belüfteten Raum mit einer größeren Bodenfläche als durch folgender Formel errechnete A_{\min} (m²) gelagert werden: $A_{\min} = (M / (2.5 \times 0.22759 \times h_0))^2$
M ist die Kältemittelfüllung im Gerät in und h₀ ist die Lagerungshöhe. Bei Lagerung auf dem Boden h₀ = 0,6 m.
- Die Wärmepumpe ist ausschließlich für eine Installation außerhalb von Gebäuden vorgesehen.
- Das Gerät muss durch qualifiziertes Personal installiert werden.
- Installieren Sie die Pumpe nicht auf einem Träger, der die Vibrationen des Geräts verstärken könnte.
- Prüfen Sie, dass der für das Gerät vorgesehene Träger für das Gerätgewicht korrekt dimensioniert ist.
- Installieren Sie die Pumpe nicht in einem Ort, der ihren Schallpegel verstärken könnte oder in einem Ort, in welchem das Gerätegeräusch die Nachbarschaft stören könnte.
- Alle elektrischen Anschlüsse müssen von einem qualifizierten Fachelektriker und gemäß den im Installationsland geltenden Normen ausgeführt werden – siehe § 3.4.
- Vor jeder Elektroarbeit trennen Sie die Hauptstromversorgung und schalten Sie den Trennschalter ab. Jede Versäumnis kann zum Stromschlag führen.

1. VORWORT (Fortsetzung)

- Prüfen Sie vor der Installation, dass das Erdkabel nicht geschnitten oder getrennt ist.
- Schließen und spannen Sie das Stromanschlusskabel korrekt an. Ein fehlerhafter Anschluss kann zur Beschädigung von Elektroteile führen.
- Falls die Wärmepumpe Wasser bzw. einer feuchten Umgebung ausgesetzt wird, kann daraus einen Stromschlag resultieren. Seien Sie sehr aufmerksam.
- Falls Sie irgendwelchen Fehler bzw. unnormale Situation entdecken, installieren Sie nicht die Wärmepumpe und setzen Sie sich sofort mit Ihrem Händler in Verbindung.
- Die Wartung und diversen Arbeiten müssen mit der in diesem Handbuch angegebenen Häufigkeit und zu den empfohlenen Zeitpunkten ausgeführt werden.
- Reparaturarbeiten müssen von qualifiziertem Personal ausgeführt werden.
- Verwenden Sie nur Originalersatzteile.
- Verwenden Sie niemals ein anderes als das in diesem Handbuch empfohlene Reinigungsverfahren.

Wichtige Informationen über das verwendete Kältemittel

Dieses Produkt enthält fluorierte Treibhausgase gemäß dem Kyoto-Protokoll. Setzen Sie diese Gase nicht in die Atmosphäre aus.

Kältemitteltyp: R32

GWP Wert (1): 675, Wert basiert auf dem 4. IPCC-Bericht.

Die auf Grundlage der Vorschrift F Gas 517/2014 Kältemittelmenge ist auf dem Typenschild des Geräts angegeben.

Gemäß europäischem oder lokalem Recht können regelmäßige Kältemittel-Lecktests erforderlich sein. Für weitere Informationen setzen Sie sich mit Ihrem Händler in Verbindung.

(1) Globaler Erwärmungsfaktor

2. TECHNISCHE EIGENSCHAFTEN

2.1 Technische Angaben zur Heizpumpenanlage

Modelle	ENERGYLINE PRO INVERTER	ENPI4M	ENPI6M
Versorgungsspannung	V	220V-240V ~ / 1ph / 50Hz	
Kältemittel	/	R32	
Ladung	kg	0,50	0,65
Gewicht in t CO ₂ -Äquivalent	/	0,34	0,44
Lecktest-Häufigkeit	/	Nicht vorgeschrieben aber jährlich empfohlen	
Wärmeleistung Min--Max ^(a)	kW	2,50--9,73	3,20--11,9
Elektrische Leistungsaufnahme Min--Max ^(a)	kW	0,20--1,34	0,28--1,68
Nennstrom im Betrieb Min--Max ^(a)	A	1,33--6,02	1,34--7,32
COP Max--Min (a)	/	12,32--7,12	11,51--7,10
Wärmeleistung Min--Max ^(b)	kW	1,71--7,60	2,70--9,70
Elektrische Leistungsaufnahme Min--Max ^(b)	kW	0,27--1,49	0,44--1,88
COP Max--Min ^(b)	/	6,40--5,1	6,10--5,55
Maximaler Betriebsstrom (MBS)	A	7,30	8,90
Sicherungswert	aM	8	10
Schutzschalter Typ D	D	8	10
Anlaufstrom	A	< MBS	< MBS
Hydraulikanschluss	mm	50mm	
Nenn-Wasserdurchsatz (a)	m ³ /h	4,20	5,10
Max. wasserseitiger Druckverlust	kPa	3,3	4,5
Kompressor	/	DC Inverter Mitsubishi	DC Inverter Highly
Typ	/	Zweistufiger Schraubenkompressor	
Anzahl	/	1	
Wicklungswiderstand bei 20°C	Ohm	1,91	0,788
Gebälse	/	Axial	
Anzahl	/	1	
Durchmesser	mm	405	510
Schaufelanzahl	/	3	
Motor	/	DC Inverter	
Anzahl	/	1	1
Drehzahl	U/Min.	500--700	500-650
Drehzahl im Ruhemodus	U/Min.	300	400
Schalldruckpegel in 1 m Abstand	dB(A)	33--41	33-41
Schalldruckpegel in 10 m Abstand	dB(A)	16--25	16--25
Nettoabmessungen des Geräts (L-B-H)	mm	1046/400/768	
Gewicht	kg	53	65



(a) Trockene Luft 27°C - Relative Feuchte 78% - Wassereinslasstemperatur 26°C.

(b) Trockene Luft 15°C - Relative Feuchte 71% - Wassereinslasstemperatur 26°C

2. TECHNISCHE EIGENSCHAFTEN (Fortsetzung)

2.2 Betriebsbereich

Benutzen Sie die Heizpumpenanlage innerhalb der folgenden Temperatur- und Luftfeuchtigkeitsbereichen, um ein sicheres und effizientes Funktionieren zu garantieren.

	Modus Erwärmen 	Modus Abkühlen 
Außentemperatur	-12°C – +35°C	+7°C – +43°C
Wassertemperatur	+12°C – +40°C	+8°C – +40°C
relative Luftfeuchtigkeit	< 80%	< 80%
Einstellbereich des Sollwerts	+15°C – +32°C	+8°C – +32°C



Wenn Temperatur oder Luftfeuchtigkeit nicht diesen Bedingungen entsprechen, können Sicherheitsmaßnahmen ausgelöst werden. Dann arbeitet die Heizpumpenanlage nicht mehr.



Die Höchsttemperatur für die Beheizung beträgt 32 °C, um eine Beschädigung der Verkleidung zu vermeiden. Hayward übernimmt keinerlei Verantwortung bei einer Verwendung über +32 °C.

2. TECHNISCHE EIGENSCHAFTEN (Fortsetzung)

2.3 Maße

Modelle:

ENPI4M / ENPI6M

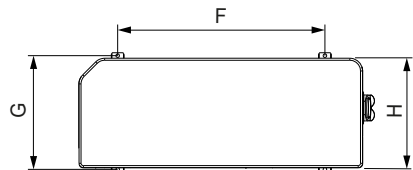
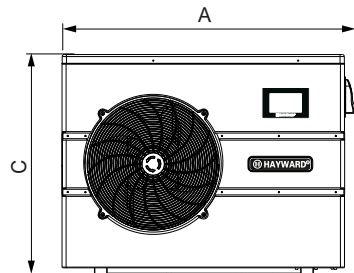
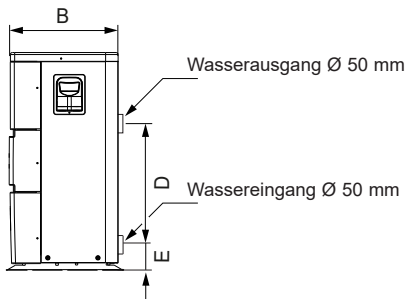

Einheit : mm

Markierung \ Modell	ENPI4M / ENPI6M
A	1046
B	400
C	768
D	350
E	110
F	615
G	428
H	400

3. INSTALLATION UND ANSCHLUSS

3.1 Schematische Darstellung

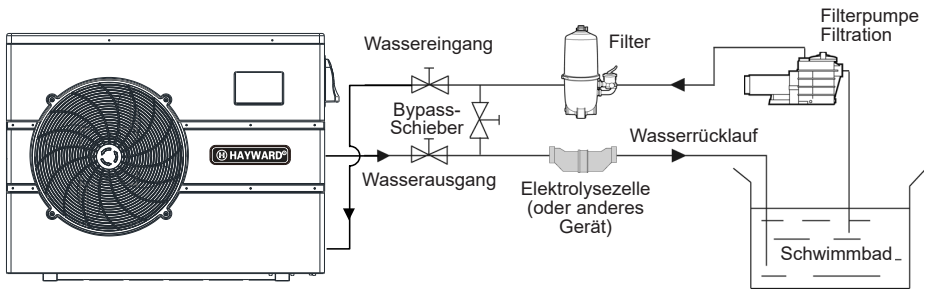

Anmerkung: Die Heizpumpenanlage verfügt über keinerlei Ausstattungs- oder Filtergerät. Die auf der Darstellung gezeigten Elemente werden vom Installateur bereitgestellt.

3.2 Heizpumpenanlage



Stellen Sie die Heizpumpenanlage im Außenraum und außerhalb vollständig geschlossener technischer Orte auf.

Geschützt aufgestellt muss der vorgeschriebene Mindestabstand wie unten genannt eingehalten werden, um die Gefahr einer Luftrückführung oder einer Minderung der effektiven Betriebsleistung der Heizpumpenanlage zu vermeiden.

Einheit : mm

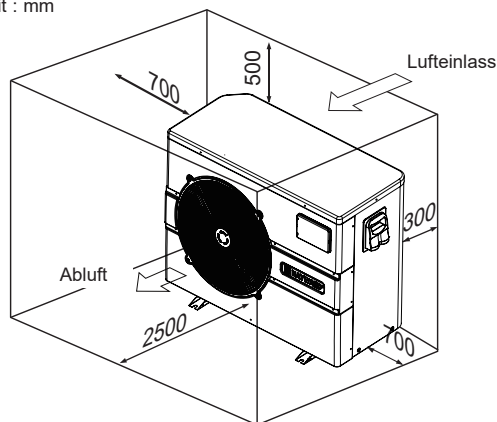

3. INSTALLATION UND ANSCHLÜSSE (Fortsetzung)



Installieren Sie vorzugsweise die Heizpumpenanlage auf einer separaten Betonbodenplatte oder auf einer festen Bestuhlung, die für diesen Zweck bestimmt ist und stellen Sie die Heizpumpenanlage auf die mitgelieferten Silentblöcke (Verschraubung und Unterlegscheiben nicht mitgeliefert).

Maximale Entfernung zwischen Heizpumpenanlage und Schwimmbecken 15 Meter.

Gesamtlänge (hin und zurück) der hydraulischen Leitungen 30 Meter.

Isolieren Sie sowohl die sichtbaren als auch die verdeckten hydraulischen Leitungen.

Die Wärmepumpe ist mit einem Mindestabstand vom Becken gemäß NF C 15-100 (d. h. für Frankreich 3,5 m entfernt von der Wasseroberfläche) oder gemäß den in den jeweiligen Ländern geltenden Installationsstandards zu installieren.

Die Wärmepumpe nicht in der Nähe einer Wärmequelle installieren.

Bei einer Installation in schneereichen Gebieten wird eine Abdeckung der Maschine empfohlen, um eine Schneeanhäufung auf dem Verdampfer zu verhindern.

3.3 Hydraulischer Anschluss

Die Heizpumpenanlage wird mit zwei Verbindungsstücken mit einem Durchmesser von 50 mm geliefert. Verwenden Sie PVC-Rohre mit 50 mm Durchmesser für das hydraulische Leitungsnetz. Schließen Sie die den Wassereingang der Heizpumpenanlage an die Leitung der Filtergruppe an. Schließen Sie dann den Wasserausgang der Heizpumpenanlage an die Wasserleitung des Beckens an (s. Darstellung weiter unten).

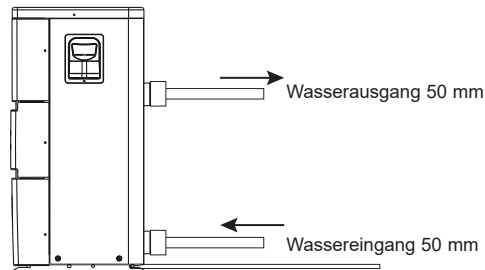

Installieren Sie einen Schieber, den so genannten "By-pass", zwischen den Eingang und den Ausgang der Heizpumpenanlage.



Wird ein automatischer Verteiler oder ein Elektrolyseur verwendet, muss dieser unbedingt nach der Heizpumpenanlage eingebaut werden, um so den Titan-Kondensator gegen eine zu hohe Konzentration chemischer Produkte zu schützen.



Achten Sie darauf, den By-pass-Schieber und die Verbindungsstücke am Ein- und Auslass der Anlage einzubauen, um den problemlosen Ablass der Anlage während der Wintermonate und einen einfacheren Zugang oder einen Abbau bei Wartungsarbeiten zu erleichtern.

3. INSTALLATION UND ANSCHLÜSSE (Fortsetzung)

3.4 Elektrischer Anschluss



Die Elektroinstallation und die Verkabelung dieses Gerätes müssen den geltenden Installationsvorschriften vor Ort entsprechen.

F	NF C15-100	GB	BS7671:1992
D	DIN VDE 0100-702	EW	EVHS-HD 384-7-702
A	ÖVE 8001-4-702	H	MSZ 2364-702/1994/MSZ 10-553 1/1990
E	UNE 20460-7-702 1993, RECBT ITC-BT-31 2002	M	MSA HD 384-7-702.S2
IRL	Wiring Rules (Richtlinien elektrischer Leitungen, Anm. d. Übers.) + IS HD 384-7-702	PL	PN-IEC 60364-7-702:1999
I	CEI 64-8/7	CZ	CSN 33 2000 7-702
LUX	384-7.702 S2	SK	STN 33 2000-7-702
NL	NEN 1010-7-702	SLO	SIST HD 384-7-702.S2
P	RSIUEE	TR	TS IEC 60364-7-702



Prüfen Sie, ob die verfügbare Stromversorgung und die Netzfrequenz den den erforderlichem Betriebsstrom entsprechen. Dabei müssen der jeweilige Standort des Gerätes und der erforderliche Strombedarf aller anderen, am gleichen Schaltkreis angeschlossener Geräte berücksichtigt werden.

ENPI4M 230V \sim +/- 10 % 50 Hz 1 Phase

ENPI6M 230V \sim +/- 10 % 50 Hz 1 Phase

Beachten Sie die schematische Darstellung der Verkabelung im Anhang. Die Anschlussbox befindet sich auf der rechten Seite der Anlage. Es gibt drei Anschlüsse für die Stromversorgung und zwei für die Steuerung der Filterpumpe (Nachlaufsteuerung).

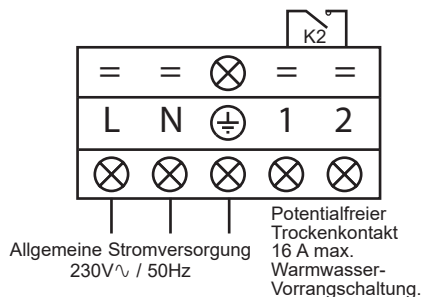

3. INSTALLATION UND ANSCHLUSS (Fortsetzung)



Die Leitung der Stromversorgung muss ordnungsgemäß mit einer Gerätesicherung vom Typ Motorversorgung (aM) oder einem Hauptschalter D sowie einem Differentialschalter 30mA ausgestattet sein (siehe nachfolgende Tafel).

Modelle		ENPI4M	ENPI6M
Netzteil	V/Ph/Hz	230V $\sqrt{}$ 50Hz	230V $\sqrt{}$ 50Hz
Sicherungsdurchmesser Typ aM	A	8 aM	10 aM
Leistungsschalter Kurve D	A	8 D	10 D
Leistungsquerschnitt	mm ²	3G 2,5	3G 2,5



Ein Netzkabel vom Typ RO 2V / R 2V oder vergleichbar.



Die Leistungsquerschnitte werden für maximal 25 m Länge angegeben. Sie müssen gleichwohl überprüft und auf die Installationsbedingungen angepasst werden.



Achten Sie stets darauf, dass die Hauptstromversorgung abgeschaltet ist, bevor Sie den elektrischen Steuerkasten öffnen.

3.5 Erste Inbetriebnahme

Verfahren zur Inbetriebnahme - Nachdem Sie die Installation beendet haben, gehen Sie wie folgt vor:

- 1) Drehen Sie die Ventilatoren von Hand, um zu überprüfen, dass sie sich frei von Hand bewegen lassen und dass der Propeller korrekt auf der Antriebswelle befestigt ist.
- 2) Vergewissern Sie sich, dass die Einheit korrekt an die Hauptstromversorgung angeschlossen ist (siehe Schaltplan im Anhang).
- 3) Starten Sie die Filterpumpe.
- 4) Vergewissern Sie sich, dass alle Wasserein- und auslässe offen sind und dass das Wasser in die Anlage, bevor es erwärmt oder abgekühlt wird.
- 5) Vergewissern Sie sich, dass das Ablassrohr für das Kondensat ordnungsgemäß befestigt und frei von Blockaden ist.
- 6) Aktivieren Sie die Stromversorgung für die Anlage und drücken Sie dann den Start/Stop-Knopf  auf der Bedientafel.

3. INSTALLATION UND ANSCHLUSS (Fortsetzung)

- 7) Stellen Sie sicher, dass das Alarmsignal (\triangle) nicht rot leuchtet. Ggf. in Anleitung zur Problembehandlung (siehe § 6.4) nachschlagen.
- 8) Arretieren Sie den Wasserdurchsatz mit dem By-pass-Schieber (s. § 3.6 und 2.1), wie für das jeweilige Modell vorgeschrieben, so dass eine Temperaturdifferenz zwischen Wasserein- und -ausgang von 2°C beibehalten wird.
- 9) Nachdem die Anlage einige Minuten in Betrieb ist, vergewissern Sie sich, dass die Luft, die aus der Anlage ausströmt, sich abgekühlt hat (um 5 bis 10°).
- 10) Ist die Anlage in Betrieb, schalten Sie die Filterpumpe ab. Die Anlage sollte sich automatisch abschalten und den Fehlercode E03 anzeigen.
- 11) Lassen sie die Anlage und die Schwimmbadpumpe 24 Stunden am Tag laufen, bis die gewünschte Wassertemperatur im Pool erreicht ist. Sobald das Eingangswasser die gewünschte Temperatur erreicht hat, schaltet sich die Anlage ab. Sie wird sich dann wieder automatisch einschalten (sofern die Schwimmbadpumpe in Betrieb ist), wenn die Temperatur des Schwimmbadwassers um mehr als 0,5°C von der eingestellten Temperatur abweicht.

Wasserdurchsatzregler - Die Anlage ist mit einem Regler für den Wasserdurchsatz ausgestattet, der diese einschaltet, wenn die Pumpe des Schwimmbadfilters in Betrieb ist und der diese ausschaltet, wenn die Filterpumpe außer Betrieb ist. Fehlt Wasser, so erscheint der Alarm-Code E03 auf dem Regler (siehe § 6.4).

Zeitliche Verzögerung - Die Anlage enthält eine zeitliche Verzögerung von 3 Minuten, welche die Komponenten des Steuerschaltkreises schützt und jegliche Instabilität bezüglich eines Neustarts sowie jegliche Störung im Bereich des Kontaktgebers verhindert. Aufgrund dieser zeitlichen Verzögerung startet die Anlage ca. 3 Minuten nach jeder Unterbrechung des Steuerschaltkreises automatisch neu. Selbst eine kurze Stromunterbrechung aktiviert diese zeitliche Verzögerung.

3. INSTALLATION UND ANSCHLUSS (Fortsetzung)

3.6 Einstellung des Wasserdurchsatzes

Stellen Sie den so genannten By-pass-Schieber bei geöffneten Wassereinlass- und -auslassschiebern so ein, dass ein Unterschied von 2°C zwischen der Wassereingangstemperatur und der Wasserausgangstemperatur erreicht wird (siehe Schematische Darstellung § 3.1). Sie können die Einstellung der Eingangs- und Ausgangstemperaturen direkt auf der Bedientafel kontrollieren.



Anmerkung: Das Öffnen des By-pass-Schiebers führt zu einem geringeren Durchsatz oder zu einer Zunahme des ΔT .
Das Schließen des By-pass-Schiebers führt zu einem höheren Durchsatz oder zu einer Verringerung des ΔT .

4. BENUTZEROBERFLÄCHE

4.1 Allgemeine Darstellung

Die Heizpumpenanlage ist mit einem digitalen Touchscreen-Bedienfeld ausgestattet, elektronisch angeschlossen und werksseitig auf Heizmodus voreingestellt.

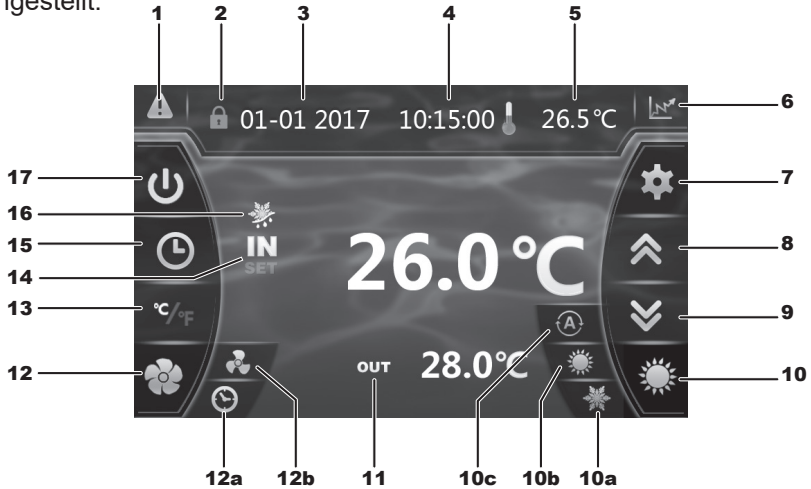

Zeichenerklärung

1		Alarm (rot blinkend)
2		Bildschirm gesperrt
3		Datum
4		Uhrzeit
5		Außentemperatur
6		Grundlage für die Erfassung (Wassertemperatur und aufgenommene Leistung)
7		Lesen der Parameter und Speicherung
8		Nach oben scrollen / Erhöhen
9		Nach unten scrollen / Verringern
10		Auswahl der Betriebsart
10a		Kühlmodus

10b		Heizmodus
10c		Automatikmodus
11		Wasserauslass
12		Auswahl Ruhemodus
12a		Einstellung Timer Ruhemodus
12b		Kontrollleuchte Ruhemodus und Aktivierung
13		Umstellung °C/°F
14		Temperatur Wassereingang
15		Einstellung Datum und Uhrzeit Timer ON/OFF
16		Abtauenmodus
17		Start/Stopp

4. BENUTZEROBERFLÄCHE (Fortsetzung)

Modus OFF

Befindet sich die Heizpumpenanlage im Stand-by-Modus (Modus OFF), ist die Schaltfläche  grau hinterlegt.

Modus ON

Befindet sich die Heizpumpenanlage in Betrieb oder in der Regulierung (Modus ON) leuchtet die Schaltfläche  grün.

4.2 Einstellung Datum und Uhrzeit



Zurück zum vorherigen
Bildschirm

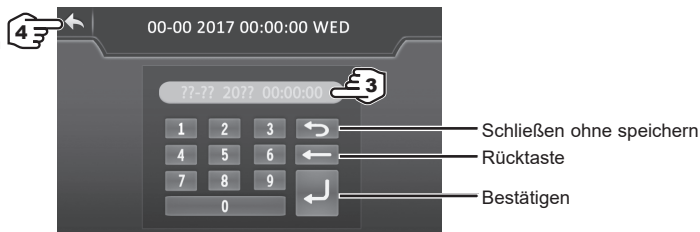

Sämtliche Felder vor dem Bestätigen ausfüllen (Tag/Monat/Jahr, «Stunde/Minute/Sekunde»), da andernfalls die Änderungen nicht gespeichert werden.

4.3 Einstellung der Timer-Funktion

Die Einstellung dieser Funktion ist notwendig, wenn Sie die Heizpumpenanlage über einen kürzeren als den von der Filteruhr vorgegebenen Zeitraum betreiben möchten. Damit können Sie einen zeitlich versetzten Beginn oder ein vorzeitiges Ende programmieren bzw. einen Teilbereich des Betriebszeitplans unterbinden (zum Beispiel nachts). Sie können 1 Start-Timer und 1 Stopp-Timer programmieren.

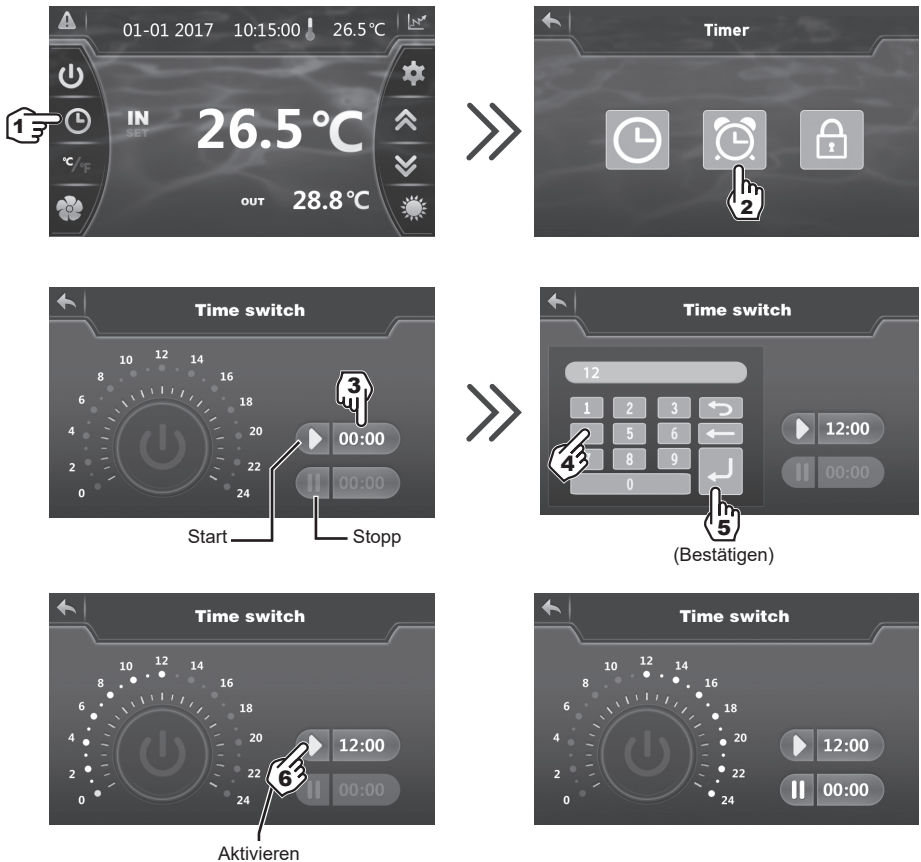

4. BENUTZEROBERFLÄCHE (Fortsetzung)



Blaue Hinterlegung = Aktiviert
Graue Hinterlegung = Deaktiviert



Die Einstellung erfolgt in Schritten von jeweils einer Stunde.



- Sobald die Startzeit eingestellt ist, auf  drücken (Schritt 6), um den Timer zu aktivieren. Das Symbol und die Uhrzeit werden blau hinterlegt.
- Die Schritte 3 bis 6 wiederholen, um die Ausschaltzeit einzustellen und zu aktivieren. ( 00:00).
- Sobald die Einstellungen erfolgt sind, erscheint der Betriebsbereich der Wärmepumpe grün hinterlegt und der Ausschaltbereich gelb hinterlegt.
- Zweimal auf  drücken, um zum Hauptbildschirm zurückzukehren.

4. BENUTZEROBERFLÄCHE (Fortsetzung)

4.4 Einstellung und Anzeige des Sollwerts



Im Modus “OFF” und im Modus “ON”

Drücken Sie die Knöpfe , damit der Sollwert angezeigt wird, und drücken Sie dann auf  oder  um den gewünschten Sollwert festzulegen.

Durch drücken auf , bestätigen, die Rückkehr zum Hauptbildschirm erfolgt automatisch,



Die Einstellung erfolgt mit einer Präzision von 0,5 °C.



Es wird empfohlen, niemals eine Temperatur von 30°C zu überschreiten, um Veränderungen der Auskleidungen zu vermeiden

4. BENUTZEROBERFLÄCHE (Fortsetzung)



4.5 Sperren und Entsperren des Touchscreen.

Der Kontrollbildschirm wird automatisch nach einer Minute gesperrt (Werkseinstellung).

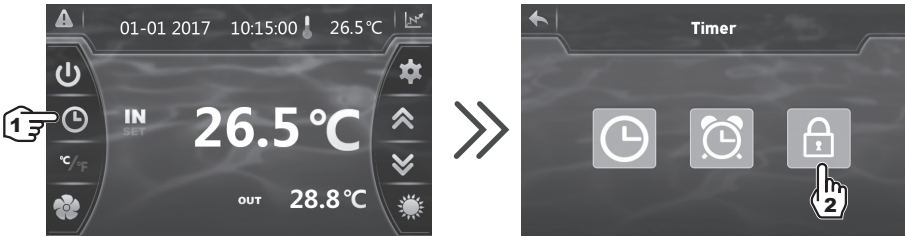
Die Zeit, bevor der Bildschirm automatisch gesperrt wird, kann angepasst (1 bis 10 Minuten) werden. Die Funktion lässt sich aber auch komplett aufheben.



Automatische Sperre aktiviert

- 3) Zeit zwischen 1 und 10 Minuten anpassen. Die Speicherung erfolgt automatisch,
- 4) Zweimal auf  drücken, um zum Hauptbildschirm zurückzukehren
- 5) Um die automatische Sperre zu deaktivieren, auf  drücken

Um den Bildschirm zu entsperren, 2 s lang auf eine beliebige Stelle am Bildschirm drücken.

Den Code "22" eingeben und bestätigen durch Drücken der Schaltfläche **EN**



4. BENUTZEROBERFLÄCHE (Fortsetzung)

4.6 Activation et réglage du mode SILENCE

Der Ruhemodus ermöglicht eine äußerst leise Nutzung der Wärmepumpe Energiesparmodus, da der Heizbedarf gering ist (Aufrechterhaltung der Beckentemperatur oder falls extrem leiser Betrieb erforderlich).

Diese Funktion kann entweder manuell oder über eine Zeitschaltung Aktiviert/ Deaktiviert werden.

Manuelle Aktivierung

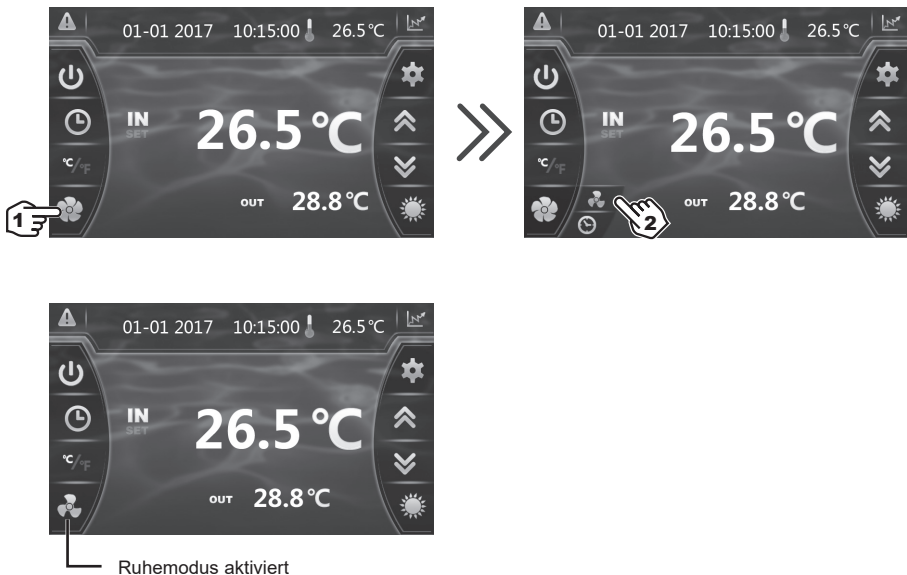

4. BENUTZEROBERFLÄCHE (Fortsetzung)

Manuelle Deaktivierung



Ruhemodus deaktiviert

Einstellung des Timer

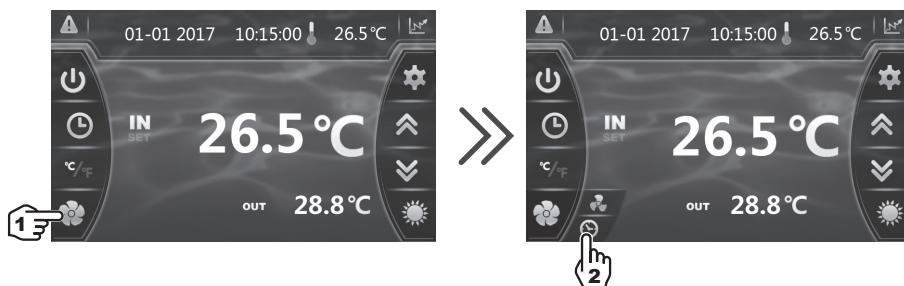

4. BENUTZEROBERFLÄCHE (Fortsetzung)

Einstellung des Timer (Fortsetzung)

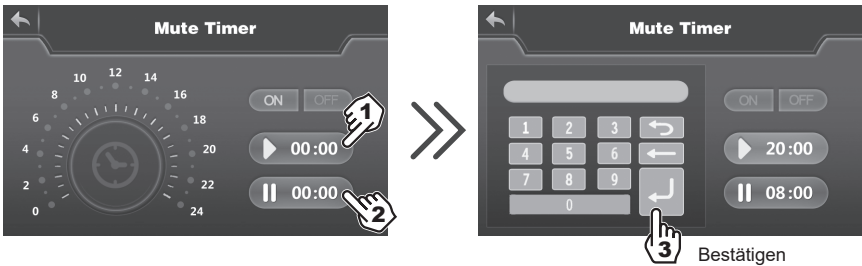

- 1) Startzeit, Eingabe und Bestätigung.
- 2) Endzeit, Eingabe und Bestätigung.
- 3) Bestätigen.

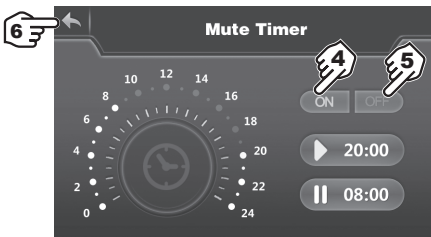

- 4) Aktivierung.
- 5) Deaktivierung.
- 6) Zurück zum Hauptbildschirm.



**Die Einstellung erfolgt in Schritten von jeweils einer Stunde.
Sobald der Timer aktiviert ist, ist er 7 Tage in der Woche aktiv.**

5. WARTUNG UND WINTERZEIT

5.1 Wartung

Diese Maßregeln zur Wartung müssen ein Mal pro Jahr durchgeführt werden, um die Langlebigkeit und gute Funktionsweise der Heizpumpenanlage zu garantieren.

- Reinigen Sie den Evaporator mit Hilfe einer flexiblen Bürste, einem Luft- oder einem Wasserstrahl (**Achtung: Verwenden Sie niemals einen Hochdruckreiniger**).
- Kontrollieren Sie den korrekten Abfluss des Kondensats.
- Kontrollieren Sie die hydraulischen und elektrischen Anschlüsse.
- Kontrollieren Sie die hydraulische Dichtigkeit des Kondensator.
- Die Dichtheit des Kältekreislaufs mithilfe eines Leckdetektors **durch eine autorisierte Fachkraft** prüfen lassen.



Vor allen Wartungsmaßnahmen muss die Heizpumpenanlage von jeglicher Stromversorgung getrennt werden. Die Wartungsmaßnahmen müssen von einem qualifizierten Fachmann durchgeführt werden, dem der Umgang mit Kühlfüssigkeiten vertraut ist.

5.2 Winterzeit

- Stellen Sie die Heizpumpenanlage auf den Modus "OFF".
- Trennen Sie die Heizpumpenanlage von der Stromversorgung.
- Leeren Sie den Kondensator mit Hilfe des Wasserablassers, um jegliche Schadensgefahr zu vermeiden. (großes Frostrisiko).
- Schließen Sie den By-pass-Schieber und lösen Sie die Eingangs- und Ausgangsverbindungsstücke.
- Entfernen Sie so gut es geht das Altwasser im Kondensator mit Hilfe einer Druckluftpistole.
- Verschließen Sie den Wasserein- und -ausgang an der Heizpumpenanlage, um das Eindringen von Fremdkörpern zu verhindern.
- Decken Sie die Heizpumpenanlage mit der für diesen Zweck vorgesehenen Winterschutzhülle ab.



Jeglicher Schaden, der durch eine schlechte Winterlagerung entsteht, hebt alle Garantieansprüche auf.

6. ANHANG

6.1 Stromtafel

ENPI4M

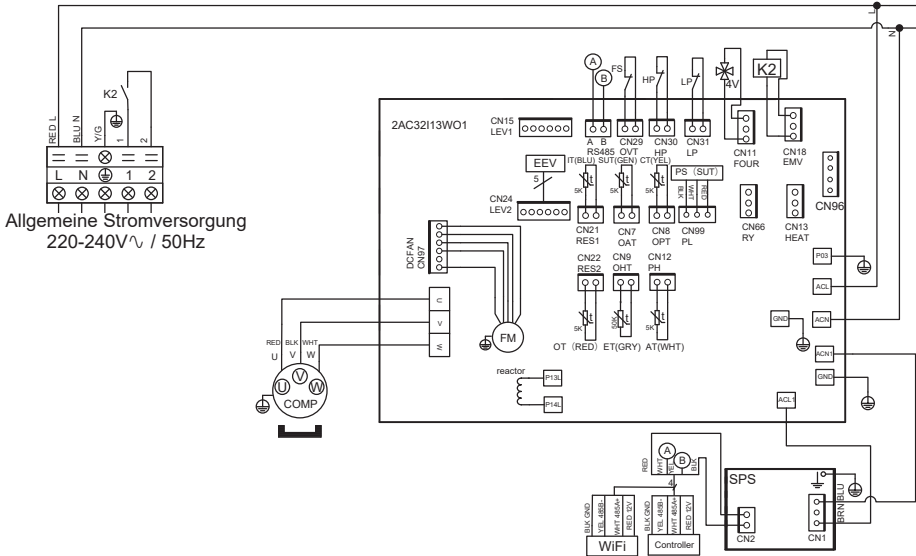

LEGENDE

- | | |
|--|---|
| AT : AUSSENTEMPERSORSOR | LP : NIEDRIGDRUCKREGLER |
| COMP : KOMPRESSOR | OT : SENSOR DER TEMPERATUR DES WASSERAUSLASSES |
| CT : TEMPERATURSENSOR DES EVAPORATORS | SUT : SENSOR DER SAUGTEMPERATUR |
| EEV : ELEKTRONISCHER SENSOR | 4V : 4-WEGE-VENTIL |
| FM : GEBLÄSEMOTOR | K2 : POTENTIALFREIER TROCKENKONTAKT MAX. 16 A |
| FS : SENSOR DES WASSERSTANDES | ET : DRUCKTEMPERATURSONDE |
| HP : HOCHDRUCKREGLER | PS : DRUCKSENSOR |
| IT : WASSEREINLASSES | |

6. ANHANG (Fortsetzung)

ENPI6M

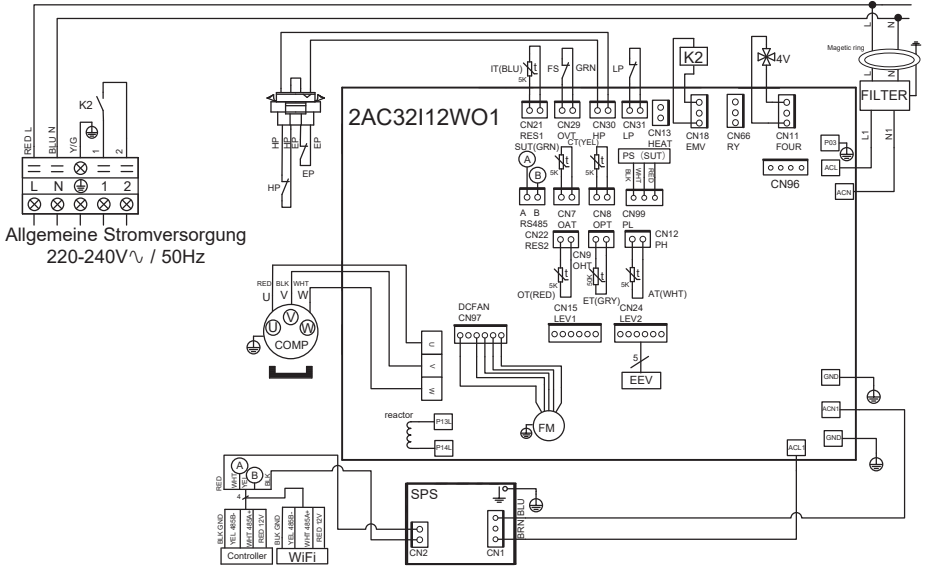

LEGENDE

- | | |
|--|---|
| AT : AUSSENTEMPERSURSENSOR | LP : NIEDRIGDRUCKREGLER |
| COMP : KOMPRESSOR | OT : SENSOR DER TEMPERATUR DES WASSERAUSLASSES |
| CT : TEMPERATURSENSOR DES EVAPORATORS | SUT : SENSOR DER SAUGTEMPERATUR |
| EEV : ELEKTRONISCHER SENSOR | 4V : 4-WEGE-VENTIL |
| FM : GEBLÄSEMOTOR | K2 : POTENTIALFREIER TROCKENKONTAKT MAX. 16 A |
| FS : SENSOR DES WASSERSTANDES | ET : DRUCKTEMPERATURSONDE |
| HP : HOCHDRUCKREGLER | PS : DRUCKSENSOR |
| IT : WASSEREINLASSES | |

6. ANHANG (Fortsetzung)

6.2 Vorrangige Heizanschlüsse einphasige Pumpe

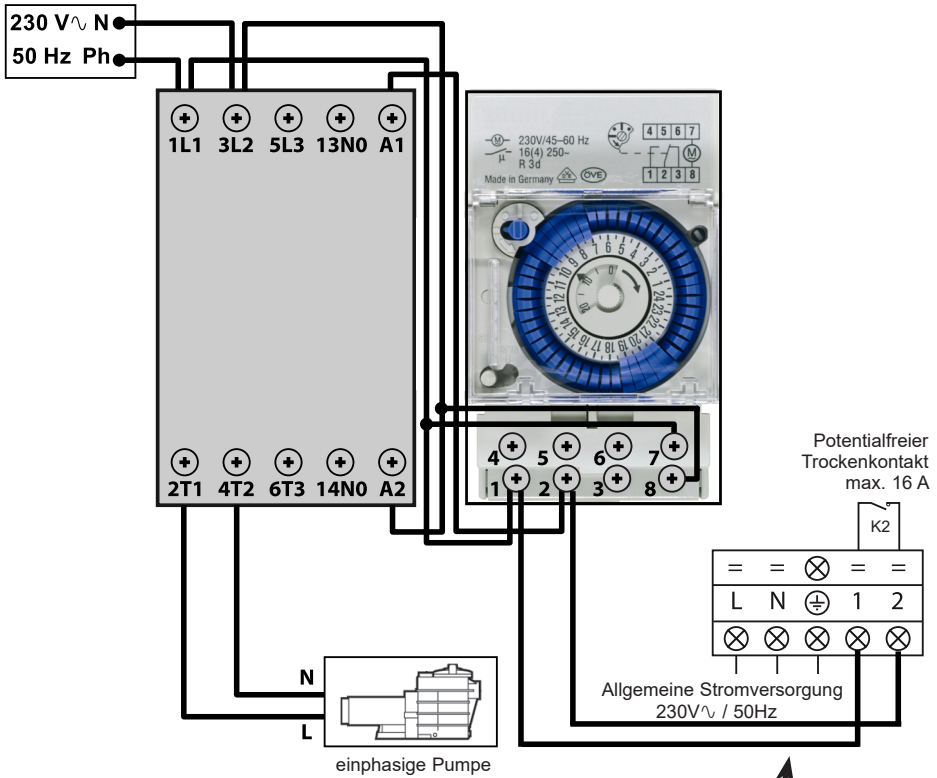

Die Anschlüsse 1 und 2 liefern einen potenzialfreien Trockenkontakt ohne Polarität 230 V \sim / 50 Hz. Verkabeln Sie die Anschlüsse 1 und 2 unter Berücksichtigung des folgenden Kabelschemas, um die Filtrationspumpe jede Stunde in einem 2-Minuten-Zyklus zu aktivieren, wenn die Temperatur des Beckens unter den Sollwert fällt.

! Die Stromversorgung der Filtrationspumpe niemals direkt an die Anschlüsse 1 und 2 anschließen.



Seite bewusst leer gelassen

6. ANHANG (Fortsetzung)

6.3 Explosionszeichnungen und Einzelteile

ENPI4M / ENPI6M

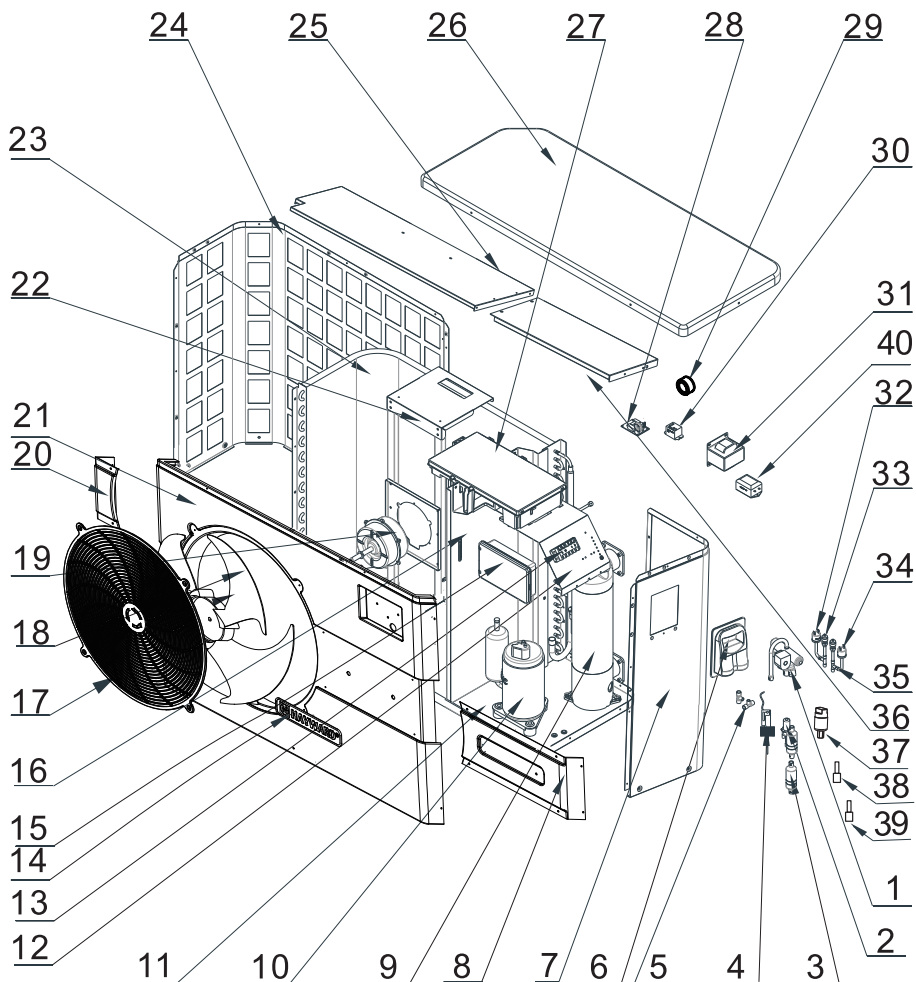

6. ANHANG (Fortsetzung)

ENPI4M / ENPI6M

Nr	Beschreibung	Ref.	ENPI4M	ENPI6M
1	4-Wege-Ventil	HWX20041437	✓	✓
2	Elektronischer Sensor	HWX81000015	✓	n/a
		HWX81000016	n/a	✓
3	Filter ø9.7-ø9.7 (Ø28)	HWX20041444	✓	✓
4	Sensor des Wasserdurchsatzes	HWX83000012	✓	✓
5	T-Stecker ø9.52-2 x ø6.5(T) x 1.0	HWX304030000002	✓	✓
6	Stromanschlussklappe	HWX320922029	✓	✓
7	Rechtes Schild	HWX80700455	✓	✓
8	Dekorative Platte rechts	HWX80900089	✓	✓
9	Titan/PVC--Kondensator	HWX80600074	✓	n/a
		HWX80600096	n/a	✓
10	Kompressor	HWX20000110448	✓	n/a
		HWX80100003	n/a	✓
11	/	/	/	/
12	/	/	/	/
13	Klemmleiste L-N-GND -5 Anschlüssen 4mm ²	HWX40003901	✓	✓
14	HAYWARD-Logo	HWX20000230596	✓	✓
15	Farb-Touchscreen	HWX95005310612	✓	✓
16	/	/	/	/
17	Schutzgitter des Gebläses	HWX20000220169	✓	✓
18	Gebläsepropeller	HWX20000270004	✓	✓
19	Motor Ventilator DC	HWX20000330132	✓	✓
20	Dekorative Platte links	HWX80900088	✓	✓
21	Schild Vorne	HWX80900087	✓	✓
22	Motorträger	HWX80700248	✓	✓
		HWX80600044	✓	n/a
23	Flügelevaporator	HWX80600100	n/a	✓
24	Linkes Schild	HWX80700455	✓	✓
25	/	/	/	/
26	Obere Platte	HWX301090200806	✓	✓
		HWX82300008	✓	n/a
27	Elektronische Treiberkarte	HWX82300007	n/a	✓
		HWX82600008	✓	✓
28	Transformator 230V~/12VDC	HWX82600008	✓	✓
29	/	/	/	/
30	Relais K2	HWX20000360297	✓	✓
31	Wicklung 20A 50Hz 5mH	HWX82500005	✓	✓
32	Druckregler Niederdruck NO 0.30MPa/0.15MPa	HWX20000360157	✓	✓
33	Druckanschluss 40 mm 1/2"	HWX20000140150	✓	✓
34	Druckregler Hochdruck NC 3.2MPa/4.4MPa	HWX20013605	✓	✓
35	T-Stecker ø6.5-2 x ø6.5(T) x 0.75T2M	HWX20001460	✓	✓
36	/	/	/	/
37	Drucksensor	HWX20000360123	✓	✓
38	Abgabekompressorsensor 50k-660mm	HWX83000026	✓	✓
39	Lufttemperatursensor 5k-350mm	HWX83000049	✓	✓
	Sensor des Wasserauslasses 5k-410mm	HWX83000050	✓	✓
	Sensor des Wassereinlasses 5k-850mm	HWX83000052	✓	✓
	Saugsonde des Kompressors 5k-560mm	HWX83000044	✓	✓
	Abtaulsonde 5k-680mm	HWX83000051	✓	✓
40	EMV-Filter	HWX20003257	n/a	✓

6. ANHANG (Fortsetzung)

6.4 Anleitung zur Fehlerbehebung



Manche Maßnahmen müssen von einem mit der Anlage vertrauten Techniker durchgeführt werden.

Tritt an der Wärmepumpe ein Fehler auf, erscheint das Symbol  rot blinkend in der linken Ecke des Bildschirms.

Auf das Symbol  drücken, um zur Fehlerliste zu gelangen.

Im Falle einer Störung erscheinen die folgenden Anzeigen auf dem Bildschirm:

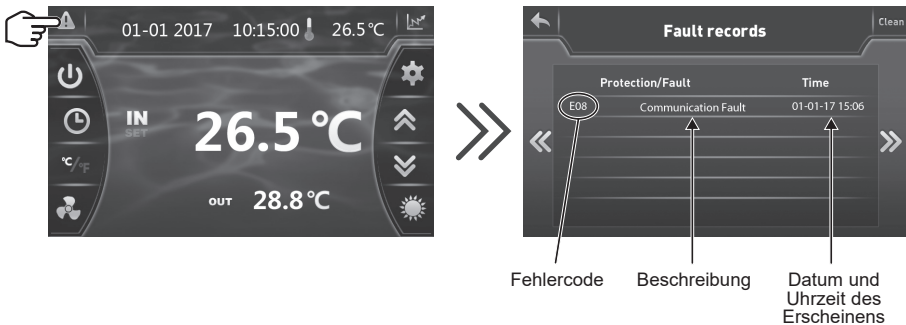

Nach Lösung des Problems wird der Fehler automatisch quittiert, das Dreieck wird wieder dauerhaft grau.



Um die Fehlerliste zu löschen, auf **Clean drücken, und durch Betätigung von  auf den vorherigen Bildschirm zurückkehren.**

6. ANHANG (Fortsetzung)

Störung	Fehlercode	Beschreibung	Lösung
Ausfall des Sensors des Wassereinlasses	P01	Der Sensor ist offen oder kurzgeschlossen	Prüfen Sie die Verbindung CN21/RES1 auf der Karte und den Verlängerungsstecker oder tauschen Sie den Sensor aus.
Ausfall des Sensors des Wasserauslasses	P02		Prüfen Sie die Verbindung N22/RES2 auf der Karte und den Verlängerungsstecker oder tauschen Sie den Sensor aus.
Ausfall des Außentempersensors	P04		Prüfen Sie die Verbindung CN12/PH auf der Karte und den Verlängerungsstecker oder tauschen Sie den Sensor aus.
Ausfall des Magnetspulensensors	P05		Prüfen Sie die Verbindung CN8/OPT auf der Karte und den Verlängerungsstecker oder tauschen Sie den Sensor aus.
Fehler an der Saugsonde des Kompressors	P07		Prüfen Sie die Verbindung CN7/OAT auf der Karte und den Verlängerungsstecker oder tauschen Sie den Sensor aus.
Fehler Fördermengenfühler des Kompressors	P081		Prüfen Sie die Verbindung CN9/OHT auf der Karte und den Verlängerungsstecker oder tauschen Sie den Sensor aus.
Hochdruckregler	E01	Der Sensor ist offen oder kurzgeschlossen	Prüfen Sie die Verbindung CN30/HP an der Karte prüfen oder Sensor ersetzen.
			Wasserdurchfluss prüfen
			Wasserdurchflussmesser prüfen
			Öffnung der Ventile prüfen
			Druckausgleicher prüfen
			Verschmutzung des Verdampfers prüfen
			Wassertemperatur zu warm
			Problem von nicht kondensierbarem Material nach einer Wartung, Kältekreislaufs leeren und evakuieren.
Zu hohe Kältemittelfüllung, Flüssigkeit in eine Flasche ableiten.			
Niedrigdruckregler	E02	Der Sensor ist offen oder kurzgeschlossen	Den Anschluss AI/DI03 an der Karte prüfen oder Sensor ersetzen.
			Großes Kältemittelleck, Leck mit Detektor suchen
			Zu geringer Luftstrom, Drehzahl des Ventilators prüfen
			Verschmutzung des Verdampfers prüfen, dessen Oberfläche reinigen
Ausfall des Durchsatzsensors	E03	Der Sensor ist offen oder kurzgeschlossen	Den Anschluss AI/DI02 an der Karte prüfen oder Sensor ersetzen.
			Fehlendes Wasser, Funktion der Filterpumpe prüfen
			Öffnung der Absperrventile prüfen
			Einstellung des Druckausgleichers prüfen

6. ANHANG (Fortsetzung)

Störung	Fehlercode	Beschreibung	Lösung
Differenz Temperatur Eingang/ Ausgang > 13 °C	E06	Nur im Modus Kalt anwendbar	Fehlendes Wasser, Funktion der Filterpumpe prüfen
			Öffnung der Absperrventile prüfen
			Einstellung des Druckausgleichers prüfen
Frostschutz Frostmodus	E07	Temperatur Wasserausgang < 4 °C	Wärmepumpe stoppen, Kondensator leeren, Frostgefahr
Kommunikationsproblem	E08	Keine Kommunikation zwischen der elektronischen Karte und der Benutzeroberfläche	Prüfen Sie die Anschlüsse und die Verbindung – siehe Schaltschema
Frostschutz der Stufe 1	E19	2° < Wassertemperatur < 4° und Lufttemperatur < 0°	Den Betrieb der Wärmepumpe anhalten, den Kondensator leeren, um Frostbildung zu verhindern; standardmäßig startet die Wärmepumpe die Filterpumpe, um Frostbildung zu verhindern
Frostschutz der Stufe 2	E29	Wassertemperatur < 2° und Lufttemperatur < 0°	Den Betrieb der Wärmepumpe anhalten, den Kondensator leeren, um Frostbildung zu verhindern; standardmäßig startet die Wärmepumpe die Filterpumpe, um Frostbildung zu verhindern
Fehler des Gebläsemotors	F031	Blockierter Motor oder Anschlussfehler	Prüfen Sie die freie Drehung; prüfen Sie die Verbindung CN97/DCFAN; tauschen Sie den Motor aus
Fehler des Gebläsemotors	F051	Anschlussfehler	Prüfen Sie die Verbindung DCFAN/ CN97; tauschen Sie den Motor aus
Außentemperatur zu niedrig	TP	Betriebsgrenze erreicht	Schalten Sie die Wärmepumpe aus
Fehler Drucksensor	PP	Der Sensor ist offen oder kurzgeschlossen	Anschluss prüfen (gemäß Schaltplan)

6. ANHANG (Fortsetzung)

6.5 Grundlage für die Erfassung

Auf dem Hauptbildschirm auf  drücken, um zum gespeicherten Verlauf der Wassereingangs- und Wasserausgangstemperaturen zu gelangen.



Diese Daten sind 60 Tage lang verfügbar.

Auf  drücken, um zur verbrauchten durchschnittlichen elektrischen Leistung zu gelangen.

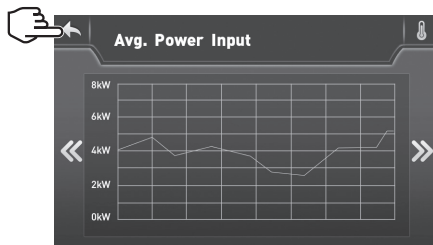
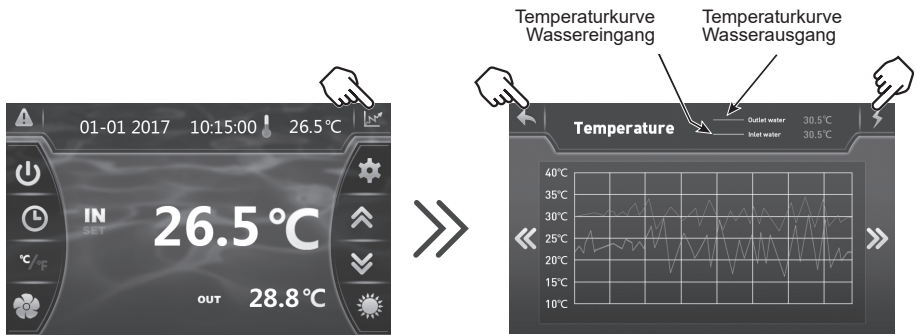

Auf  drücken, um zum Hauptbildschirm zurückzukehren.

6. ANHANG (Fortsetzung)

6.6 Garantie

GARANTIEVORAUSSETZUNGEN

Für sämtliche HAYWARD-Produkte bestehen innerhalb von zwei Jahren ab Kauf des Produkts Garantien hinsichtlich sämtlicher Fertigungsfehler oder Materialmängel. Bei jedem Antrag auf Garantie muss der Nachweis des Kaufs, einschließlich des Belegs zum Kaufdatum, erbracht werden. Wir bitten Sie also um Aufbewahrung Ihrer Rechnung.

Die HAYWARD-Garantie, die grundsätzlich ganz im Ermessen von HAYWARD liegt, beschränkt sich auf die Reparatur oder den Ersatz, hinsichtlich fehlerhafter Produkte, sofern sie sachgemäß benutzt wurden, nämlich in Übereinstimmung mit den im Benutzerleitfaden befindlichen Vorschriften; das Produkt darf keinesfalls verändert worden sein und darf ausschließlich mit den Bauteilen und Einzelteilen von HAYWARD benutzt werden. Die Garantie erstreckt sich nicht auf Beschädigungen aufgrund von Frost und Einwirkungen chemischer Substanzen.

Ausgeschlossen von der Garantie sind sämtliche sonstigen Kosten (Transport, Arbeitstätigkeit...). HAYWARD kann nicht haftbar gemacht werden für direkte oder indirekte Schäden, die sich aufgrund falscher Montage, fehlerhaften Anschlusses oder der falschen Funktion des Produkts ergeben.

Falls Sie einen Garantieantrag stellen, eine Reparatur beantragen oder ein Produkt austauschen möchten, so wenden Sie sich bitte an Ihren Händler. Ausgeschlossen ist eine Material-Rücksendung an unser Werk ist ohne unsere vorherige schriftliche Zustimmung.

Die Verschleißteile unterliegen nicht der Garantie.

ISENPINVR32

ENERGYLINE PRO iNVERTER

ZWEMBAD WARMTEPOMP



Installatie- en bedieningshandleiding

INHOUD

1. VOORWOORD	1
2. TECHNISCHE EIGENSCHAPPEN	4
2.1 Technische gegevens over de warmtepomp	4
2.2 Werkgebied	5
2.3 Afmetingen	6
3. INSTALLATIE EN AANSLUITING	7
3.1 Basisschema	7
3.2 Warmtepomp	7
3.3 Hydraulische aansluiting	8
3.4 Elektrische aansluiting	9
3.5 Eerste gebruik	10
3.6 Instelling van het waterdebiet	12
4. GEBRUIKERSINTERFACE	13
4.1 Algemene voorstelling	13
4.2 Instelling Datum en Tijd	14
4.3 De Timer instellen	14
4.4 Instelbereik en visualisatie van de gewenste waarde	16
4.5 Het touchscreen vergrendelen en ontgrendelen.	17
4.6 Instellen van de SILENCE functie	18
5. ONDERHOUD EN OVERWINTERING	21
5.1 Onderhoud	21
5.2 Overwintering	21
6. BIJLAGEN	22
6.1 Elektrische schema's	22
6.2 Aansluitingen prioriteit verwarming eenfasepomp	24
6.3 Opengewerkte tekeningen en onderdelen	26
6.4 Gids voor het probleemoplossing	28
6.5 Registratiebasis	31
6.6 Garantie	32

Aandachtig lezen en bewaren voor later gebruik.

Dit document moet aan de eigenaar van het zwebad overhandigd en door hem op een veilige plaats bewaard worden.

1. VOORWOORD

Hartelijk dank voor de aanschaf van deze Hayward zwembadwarmtepomp. De Hayward FULL INVERTER warmtepomp is ontworpen volgens strenge productienormen om te voldoen aan de hoogste kwaliteitseisen.

De Hayward warmtepompen bieden u uitzonderlijke prestaties terwijl gedurende het hele zwemseizoen door het vermogen, het elektriciteitsverbruik en het geluidsniveau aan te passen aan de verwarming van uw zwembad dankzij de FULL INVERTER-besturingslogica.



Lees de instructies in deze handleiding zorgvuldig door voordat u het apparaat in gebruik neemt.

Hayward warmtepompen zijn uitsluitend bedoeld voor het verwarmen van zwembadwater, gebruik deze apparatuur niet voor andere doeleinden.

Deze handleiding bevat alle noodzakelijke informatie over installatie, probleemoplossing en onderhoud.

Lees deze handleiding zorgvuldig door voordat u het apparaat opent of onderhoudswerkzaamheden aan het apparaat uitvoert. De fabrikant van dit product is in geen geval aansprakelijk voor enig letsel van een gebruiker of schade aan het apparaat als gevolg van mogelijke fouten tijdens de installatie, het verhelpen van storingen of onnodig onderhoud. Het is van essentieel belang om de instructies in deze handleiding te allen tijde op te volgen.

Elke aanbeveling die niet wordt opgevolgd, maakt de garantie ongeldig.

VOORWOORD (vervolg)



Veiligheidsinstructies



Dit apparaat bevat R32.

Gebruik nooit een ander koelmiddel dan R32. Elk ander gasvormig lichaam vermengd met de R32 kan abnormaal hoge drukken veroorzaken die kunnen leiden tot breuken in leidingen en/of persoonlijk letsel.

Gebruik bij reparaties of onderhoudswerkzaamheden nooit koperen buizen met een dikte van minder dan 0,8 mm.

Omdat de warmtepomp onder druk staat, mag u nooit gaten boren in de leidingen of proberen deze te solderen. Er bestaat explosiegevaar.

Stel het apparaat nooit bloot aan vlammen, vonken of andere ontstekingsbronnen. Het kan ontploffen en ernstige of zelfs dodelijke verwondingen veroorzaken.

- In geval van opslag moet de warmtepomp worden opgeslagen in een goed geventileerde ruimte met een vloeroppervlakte van meer dan A_{\min} (m²) volgens de volgende formule: $A_{\min} = (M/(2,5 \times 0,22759 \times h_0))^2$
M is de koelmiddelvulling in het apparaat in kg en h₀ is de opslaghoogte. Voor grondopslag h₀ = 0,6 m.
- De warmtepomp is uitsluitend bestemd voor installatie buiten gebouwen.
- Het apparaat moet door gekwalificeerd personeel worden geïnstalleerd.
- Installeer de warmtepomp niet op een steun die de trillingen van het apparaat kan versterken.
- Controleer of de bijgeleverde beugel voor het apparaat de juiste maat heeft voor het gewicht van het apparaat.
- Installeer de warmtepomp niet op een plaats waar het geluidsniveau kan worden versterkt of op een plaats waar het geluid van het apparaat de buurt kan verstoren.
- Alle elektrische aansluitingen moeten worden uitgevoerd door een gekwalificeerde elektromonteur en in overeenstemming met de geldende normen in het land van installatie, zie § 3.4.
- Schakel de hoofdstroomtoevoer en de hoofdschakelaar uit voordat u elektrische werkzaamheden uitvoert. Elke nalatigheid kan elektrische schokken veroorzaken.
- Controleer voor de installatie of de aardkabel niet is doorgeknipt of losgekoppeld.

VOORWOORD (vervolg)

- Sluit de voedingskabel goed aan en draai deze goed vast. Als de aansluiting niet correct is, kunnen elektrische onderdelen beschadigd raken.
- Blootstelling van de warmtepomp aan water of een vochtige omgeving kan elektrocutie veroorzaken. Wees voorzichtig.
- Als u een defect of een abnormale situatie constateert, stop dan de installatie van de warmtepomp en neem onmiddellijk contact op met uw dealer.
- Onderhoud en diverse bewerkingen moeten worden uitgevoerd met de aanbevolen frequentie en tijden, zoals aangegeven in deze handleiding.
- Reparaties moeten worden uitgevoerd door gekwalificeerd personeel.
- Gebruik alleen originele reserveonderdelen.
- Gebruik nooit een andere reinigingsprocedure dan die welke in deze handleiding wordt aanbevolen.

Belangrijke informatie over het gebruikte koelmiddel

Dit product bevat gefluoreerde broeikasgassen die onder het Kyoto-protocol vallen. Laat deze gassen niet in de atmosfeer vrijkomen.

Type koelmiddel R32

GWP-waarde(1): 675, Waarde gebaseerd op het 4e IPCC-rapport.

De hoeveelheid koudemiddel op basis van de F Gas 517/2014 regeling staat aangegeven op het typeplaatje van het apparaat.

Afhankelijk van de Europese of lokale wetgeving kunnen periodieke koelmiddellekkage-inspecties vereist zijn. Neem contact op met uw lokale distributeur voor meer informatie.

(1) Aardopwarmingsvermogen

2. TECHNISCHE EIGENSCHAPPEN

2.1 Technische gegevens over de warmtepomp

Modellen	ENERGYLINE PRO INVERTER	ENP14M	ENP16M
Voedingsspanning	V	220V-240V ~ / 1ph / 50Hz	
Koelmiddel	/	R32	
Belasting	kg	0,50	0,65
Massa in TCO ₂	/	0,34	0,44
Frequentie van de controle op lekkage	/	Geen eisen, maar jaarlijks geadviseerd	
Verwarmingscapaciteit Min--Max ^(a)	kW	2,50--9,73	3,20--11,9
Opgenomen elektrisch vermogen Min--Max ^(a)	kW	0,20--1,34	0,28--1,68
Nominale bedrijfstrom Min--Max ^(a)	A	1,33--6,02	1,34--7,32
COP Max--Min ^(a)	/	12,32--7,12	11,51--7,10
Verwarmingscapaciteit Min--Max ^(b)	kW	1,71--7,60	2,70--9,70
Opgenomen elektrisch vermogen Min--Max ^(b)	kW	0,27--1,49	0,44--1,88
COP Max--Min ^(b)	/	6,40--5,1	6,10--5,55
Maximale bedrijfstrom (MBS)	A	7,30	8,90
Vermogen van de zekering	A/m	8	10
D-curve stroomonderbreker	D	8	10
Startstroom	A	< MBS	< MBS
Hydraulische aansluiting	mm	50mm	
Nominaal waterdebiet ^(a)	m ³ /h	4,20	5,10
Max. waterdrukverlies	kPa	3,3	4,5
Compressor	/	DC-omvormer Mitsubishi	DC-omvormer Hoogst
Type	/	Dubbele roterende	Dubbele roterende
Hoeveelheid	/	1	
Wikkelweerstand bij 20°C	Ohm	1,91	0,788
Ventilator	/	Axiaal	
Hoeveelheid	/	1	
Diameter	mm	405	510
Aantal bladen	/	3	
Motor	/	DC-omvormer	
Hoeveelheid	/	1	1
Rotatiesnelheid	Tr/min	500--700	500-650
Snelheid Stille modus	Tr/min	300	400
Geluidsdruk niveau op 1m	dB(A)	33--41	33-41
Geluidsdruk niveau op 10m	dB(A)	16--25	16--25
Netto afmetingen van de eenheid (B-I-H)	mm	1046/400/768	
Gewicht	kg	53	65



(a) Droge lucht 27°C - Relatieve vochtigheid 78% - Watertoevoertemperatuur 26°C.

(b) Droge lucht 15°C - Relatieve vochtigheid 71% - Watertoevoertemperatuur 26°C

2. TECHNISCHE EIGENSCHAPPEN (vervolg)

2.2 Werkgebied

Gebruik de warmtepomp in volgende temperatuur- en vochtigheidsbereiken om een correct en efficiënt te garanderen.

	Verwarmingsmodus 	Afkoelingsmodus 
Buitentemperatuur	-12°C – +35°C	+7°C – +43°C
Watertemperatuur	+12°C – +40°C	+8°C – +40°C
Relatieve vochtigheid	< 80%	< 80%
Instelbereik van de gewenste waarde	+15°C – +32°C	+8°C – +32°C



Als de temperatuur of de vochtigheid niet aan deze voorwaarden voldoet, kunnen beveiligingen losraken en kan de warmtepomp niet meer werken.



De maximale verwarmingstemperatuur is 32°C om beschadiging van de liners te voorkomen. Hayward wijst alle aansprakelijkheid af in geval van gebruik boven 32°C.

2. TECHNISCHE EIGENSCHAPPEN (vervolg)

2.3 Afmetingen

Modellen :

ENPI4M / ENPI6M

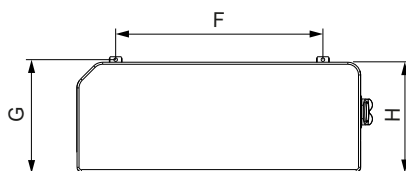
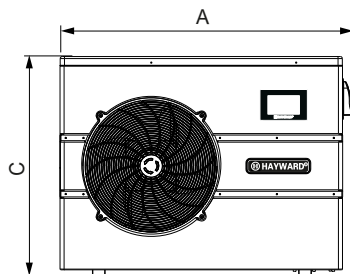
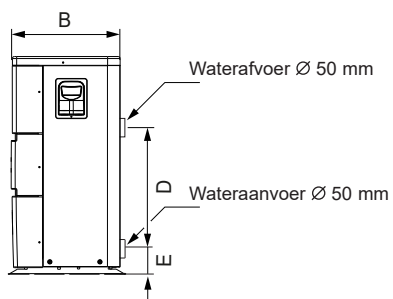

Unit : mm

Merkteken	Modell	ENPI4M / ENPI6M
A		1046
B		400
C		768
D		350
E		110
F		615
G		428
H		400

3. INSTALLATIE EN AANSLUITING

3.1 Basisschema

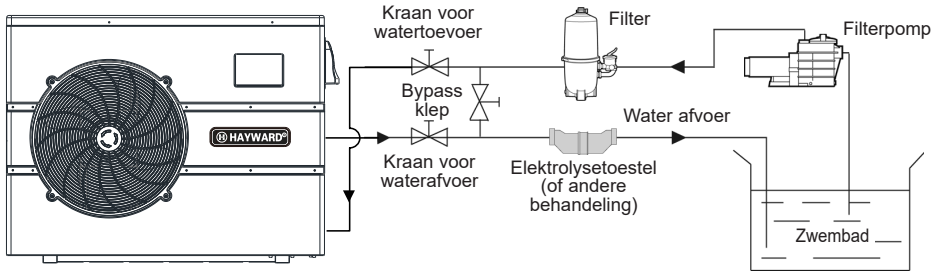

Opmerking : Met de warmtepomp wordt geen randapparatuur of filter meegeleverd. De onderdelen op het schema moeten door de installateur voorzien worden.

3.2 Warmtepomp



Plaats de pomp en openlucht en buiten een gesloten technisch locaal.

De installatie moet beschut staan en de hieronder voorgeschreven minimumafstanden moeten gerespecteerd worden om luchtterugvoer en een minder goede werking van de warmtepomp te voorkomen

Unit: mm

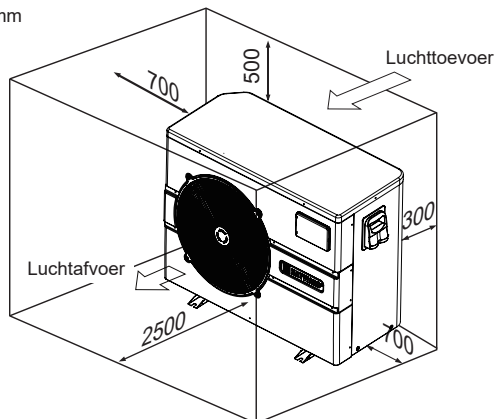

3. INSTALLATIE EN AANSLUITING (vervolg)



Installeer de warmtepomp bij voorkeur op een betonplaat of een bevestigingsstoel die voor dit doeleinde voorzien is en installeer de warmtepomp op de voorziene silentblokken (schroeven en rondellen niet meegeleverd).

De maximumafstand tussen de warmtepomp en het zwembad is 15 meter.

De totale lengte van de hydraulische leidingen is 30 meter.

De bovengrondse en ondergrondse hydraulische kanalen isoleren.

De warmtepomp moet op een minimum afstand van het bassin worden geïnstalleerd conform de NF C 15-100 (dat wil zeggen op 3,5 m van het waterbassin voor Frankrijk) of conform de geldende installatienormen in andere landen.

Installeer de waterpomp niet in de buurt van een warmtebron.

In geval van installatie in regio's waar het geregeld sneeuwt, wordt aangeraden het apparaat overdekt te installeren om te voorkomen dat er zich sneeuw op de verdampers opstapelt.

3.3 Hydraulische aansluiting

De warmtepomp is voorzien van 2 aansluitingen met een diameter van 50 mm. Gebruik PVC-buizen voor de hydraulische leidingen Ø 50 mm. Sluit de watertoevoer van de warmtepomp op de leiding die van de filtergroep komt en sluit daarna de waterafvoer van de warmtepomp op de waterleiding die naar het zwembad loopt (cv tekening hieronder).

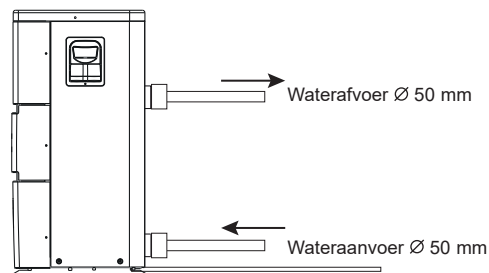

Installeer een bypassklep tussen de in- en uitgang van de warmtepomp.



Als u een automatische distributeur of een elektrolyseapparaat gebruikt, moet deze na de warmtepomp geïnstalleerd worden om de Titanium condensor tegen een te hoge concentratie aan chemische producten te beschermen.



Zorg ervoor dat de bypassklep en de aansluitingen op de aan- en afvoer van het water goed geïnstalleerd zijn om de drainage tijdens de winterperiode, de toegang en de demontage voor onderhoud te vergemakkelijken.

3. INSTALLATIE EN AANSLUITING (vervolg)

3.4 Elektrische aansluiting



De elektrische installatie en de bekabeling van deze uitrusting moeten conform zijn met de plaatselijk geldende normen.

F	NF C15-100	GB	BS7671:1992
D	DIN VDE 0100-702	EW	EVHS-HD 384-7-702
A	ÖVE 8001-4-702	H	MSZ 2364-702/1994/MSZ 10-553 1/1990
E	UNE 20460-7-702 1993, RECBT ITC-BT-31 2002	M	MSA HD 384-7-702.S2
IRL	Wiring Rules + IS HD 384-7-702	PL	PN-IEC 60364-7-702:1999
I	CEI 64-8/7	CZ	CSN 33 2000 7-702
LUX	384-7.702 S2	SK	STN 33 2000-7-702
NL	NEN 1010-7-702	SLO	SIST HD 384-7-702.S2
P	RSIUEE	TR	TS IEC 60364-7-702



Controleer of de elektrische voeding en de netwerkfrequentie overeenstemmen met de vereiste werkstroom, door rekening te houden met de specifieke plaatsing van het toestel en de noodzakelijke stroom om alle andere toestellen die op hetzelfde circuit aangesloten zijn, te voeden.

ENPI4M 230V \sim +/- 10 % 50 Hz 1 Fase

ENPI6M 230V \sim +/- 10 % 50 Hz 1 Fase

Bestudeer het overeenkomstige bedradingschema in bijlage.

De aansluitdoos bevindt zich aan de rechterkant van de eenheid. Drie connecties zijn voor de elektrische voeding en twee voor de besturing van de warmtepomp (Bediening).

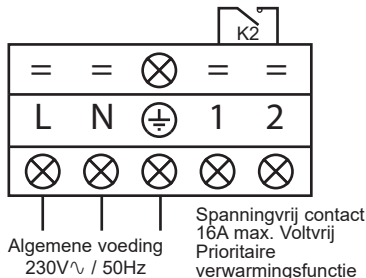

3. INSTALLATIE EN AANSLUITING (vervolg)



De elektrische voedingskabel moet, op gepaste manier, voorzien zijn van een beveiligingszekering van het type motorvoeding (aM) of een stroomonderbreker met D-curve en een differentieelschakelaar 30mA (zie tabel hieronder).

Modellen		ENPI4M	ENPI6M
Elektrische voeding	V/Ph/Hz	230V~ 50Hz	230V~ 50Hz
Smeltzekering type aM	A	8 aM	10 aM
Stroomonderbreker met D-curve	A	8 D	10 D
Kabelsectie	mm ²	3G 2,5	3G 2,5



Gebruik een voedingskabel van het type RO 2V / R 2V of equivalent.



De kabelsecties worden gegeven voor een maximale lengte van 25 m. Deze moeten echter worden gecontroleerd en aangepast afhankelijk van de installatieomstandigheden.



Schakel altijd de hoofdschakelaar uit alvorens de elektriciteitsdoos te openen.

3.5 Eerste gebruik

Opstartprocedure - zodra de installatie beëindigd is, moet u de volgende stappen volgen en respecteren :

- 1) Draai de ventilatoren handmatig om te controleren of deze met de hand gedraaid kunnen worden en of het blad op de motorboom bevestigd is.
- 2) Controleer of de eenheid correct op de hoofdvoeding aangesloten is (zie bedradingsschema in bijlage).
- 3) Activeer de filterpomp.
- 4) Controleer of alle waterkleppen openstaan en dat het water naar de eenheid loopt alvorens in verwarming of koeling opstart.
- 5) Controleer of de drainageleiding correct vastgemaakt is en niet verstopt is.
- 6) Schakel de elektrische voeding van de eenheid in en druk daarna op de Start/Stop-knop  op het controlepaneel.

3. INSTALLATIE EN AANSLUITING (vervolg)

- 7) Zorg dat het alarmsignaal () niet rood oplicht. In voorkomende gevallen de storingsgids raadplegen (zie § 6.4).
- 8) Leg het waterdebiet vast met behulp van de bypassklep (zie § 3.6 en 2.1), zoals respectievelijk vastgelegd is voor ieder model, zodat er een temperatuurverschil van 2°C is tussen het Binnenkomend en Uitgaand water.
- 9) Wanneer het toestel enkele minuten gedraaid heeft, controleer dan dat de lucht die eruit komt, afgekoeld is (tussen 5° en 10°).
- 10) Stop de filterpomp terwijl de eenheid blijft draaien. De eenheid moet automatisch stoppen en de foutcode E03 weergeven.
- 11) Laat de eenheid en de zwembadpomp 24u op 24u draaien totdat de gewenste watertemperatuur bereikt is. Wanneer het binnenkomend water de gewenste temperatuur bereikt heeft, zal de eenheid stilvallen. Ze zal automatisch opstarten (als de zwembadpomp in werking is) als de temperatuur van het zwembad 0.5°C lager is dan de gewenste temperatuur.

Debietschakelaar - De eenheid is voorzien van een debietschakelaar die de warmtepomp inschakelt wanneer de filterpomp van het zwembad in werking is, en uitschakelt wanneer de de filterpomp stopt. Bij onvoldoende water zal de alarmcode E03 op de schakelaar getoond worden (Zie § 6.4).

Vertraging - De eenheid vertoont een vertraging van 3 minuten om de onderdelen van het besturingscircuit te beschermen en om onregelmatige opstart en storingen van de contactor te vermijden. Dankzij deze vertraging start de eenheid automatisch op ongeveer 3 minuten na een stroomonderbreking. Zelfs een korte stroomonderbreking zal de uitgestelde start activeren.

3. INSTALLATIE EN AANSLUITING (vervolg)

3.6 Instelling van het waterdebiet

Terwijl de kleppen voor binnenkomend en uitgaand water openstaan, moet u de bypassklep afstellen om een temperatuurverschil van 2°C tussen het binnenkomend en uitgaand water te bekomen (zie basisschema §3.1). U kan de instelling controleren voor de temperaturen van het binnenkomend en uitgaand water te visualiseren op het controlepaneel.

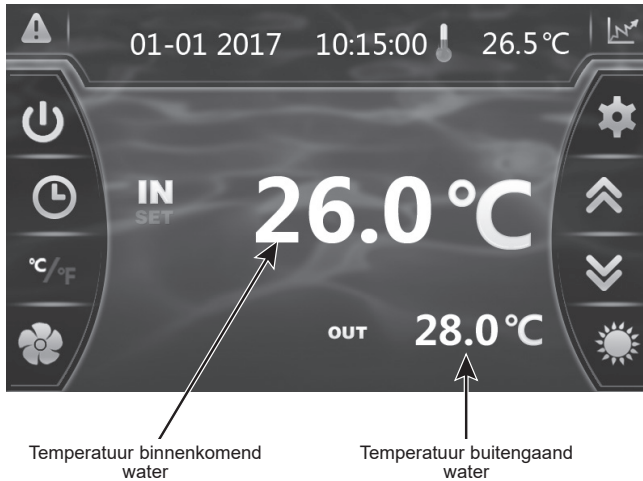

Opmerking : De opening van de bypassklep zorgt voor een lager waterdebiet.
De sluiting van de bypassklep zorgt voor een hoger waterdebiet.

4. GEBRUIKERSINTERFACE

4.1 Algemene voorstelling

De warmtepomp is uitgerust met een digitaal besturingspaneel met touchscreen, elektrisch aangesloten en voorgeïnstalleerd in verwarmingsmodus.

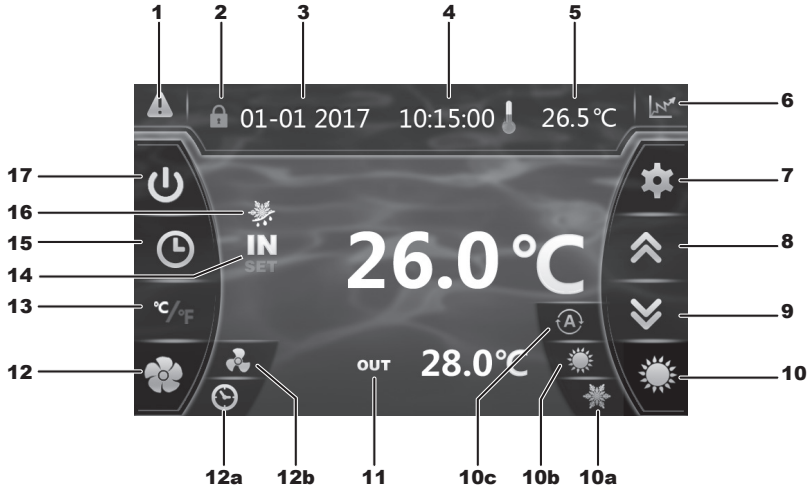

Legende

1		Alarm (rood knipperend)
2		Schermblokkade
3		Datum
4		Tijd
5		Buitemtemperatuur
6		Registratiebasis (watertemperatuur en geabsorbeerd vermogen)
7		Lezen en opslaan instellingen
8		Schuifbalk bovenaan / Verhogen
9		Schuifbalk onderaan / Verlagen
10		Selectie van de werkingsmodus
10a		Afkoelingsmodus

10b		Verwarmingsmodus
10c		Automatische modus
11		Temperatuur waterafvoer
12		Selectie stille modus
12a		Instelling timer stille modus
12b		Verklikkerlampje stille modus en activering
13		Conversie °C/°F
14		Temperatuur wateraanvoer
15		Instelling datum en tijd Timer ON/OFF
16		Modus de-icing
17		Start/Stop

4. GEBRUIKERSINTERFACE (vervolg)

Modus OFF

Wanneer de warmtepomp in slaapstand staat (Modus OFF), de knop  is grijs.

Modus ON

Wanneer de warmtepomp in werking of in gebruik is (Modus ON), de knop  licht groen op.

4.2 Instelling Datum en Tijd



Terug naar hoofdscherm

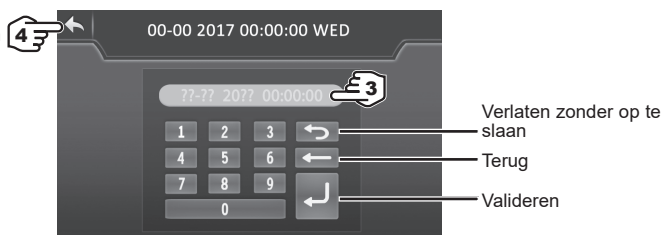

Alle velden invoeren (Dag/Maand/Jaar, Uur/Minuut/Seconde voordat u valideert, indien u dit niet doet worden de wijzigingen niet opgeslagen.

4.3 De Timer instellen

De instellingen van deze functie zijn noodzakelijk zodra u uw warmtepomp binnen een kortere termijn dan vastgelegd door de filterklok wilt gebruiken. Op die manier kunt u een uitgestelde start en een vroegtijdige uitschakeling programmeren of eenvoudigweg een periode waarin de pomp niet gebruikt mag worden.

U kunt 1 Timer Start en 1 Timer Stop programmeren.

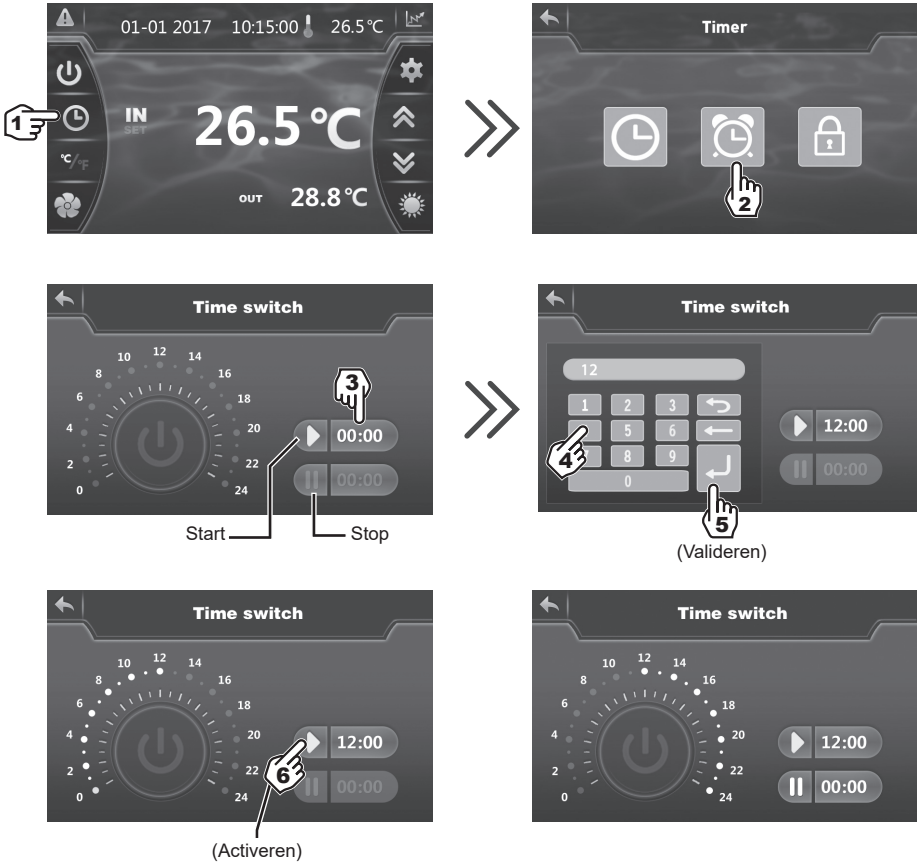

4. GEBRUIKERSINTERFACE (vervolg)



Helder blauw = Geactiveerd
Grijs = gedeactiveerd



Het instellingsinterval is van «van uur tot uur».



- Als de starttijd is ingesteld, op  drukken (stap 6) om de Timer te activeren. Het symbool en de tijd worden helder blauw weergegeven.
- De stappen 3 tot 6 opnieuw uitvoeren om de eindtijd in te stellen en te activeren ( 00:00).
- Als het instellen is afgerond, worden de werking van de warmtepomp helder groen en het eindtijdvak helder geel weergegeven.
- Druk 2 keer op  om terug te gaan naar het hoofdscherm.

4. GEBRUIKERSINTERFACE (vervolg)

4.4 Instelbereik en visualisatie van de gewenste waarde



In Modus “OFF” of “ON”

Druk op de knop  om de instructies weer te geven, en druk vervolgens op  of  om de gewenste instructie te kiezen.

Valideren door op , te drukken, het hoofdscherm verschijnt automatisch,



De waarde kan tot op 0.5°C nauwkeurig ingesteld worden.



Het is aangewezen nooit de 30°C te overschrijden om te vermijden dat de liners verkleuren.

4. GEBRUIKERSINTERFACE (vervolg)

4.5 Het touchscreen vergrendelen en ontgrendelen.

Het controlescherm vergrendelt automatisch na een minuut (standaard instelling).

De tijd voordat het scherm automatisch vergrendelt, kan worden ingesteld tussen 1 en 10 minuten of deze functie kan volledig worden geannuleerd.

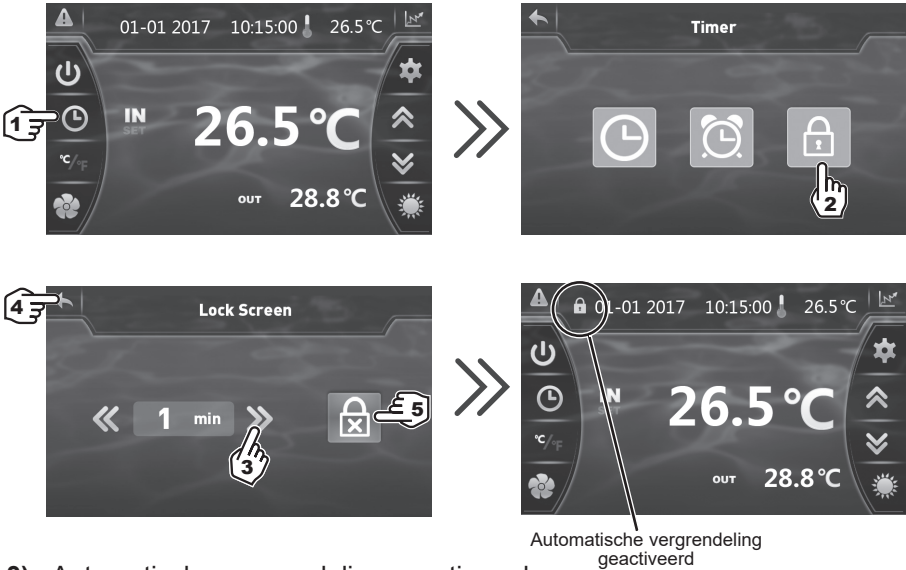

- 3) Automatische vergrendeling geactiveerd
- 4) Druk 2 keer op om terug te gaan naar het hoofdscherm.
- 5) Om het scherm te ontgrendelen, (ongeacht waar) gedurende 2 sec op het scherm drukken. .

Om het scherm te ontgrendelen, (ongeacht waar) gedurende 2 sec op het scherm drukken. Voer de code "22" in en valideer door te drukken op .



4. GEBRUIKERSINTERFACE (vervolg)

4.6 Instellen van de SILENCE functie

In de stille modus werkt de warmtepomp in de economische modus en heel stil als de verwarmingsbehoefte laag is (handhaven van de temperatuur van het bassin of indien een ultrastille werking nodig is).

Deze functie kan zowel handmatig als met behulp van een timer geactiveerd/ gedeactiveerd worden.

Handmatige activering

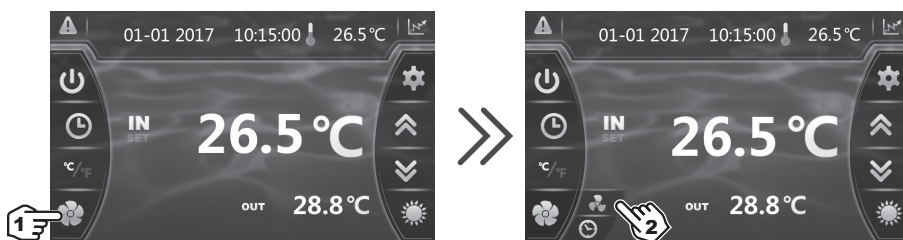

Stille modus geactiveerd

4. GEBRUIKERSINTERFACE (vervolg)

Handmatige deactivering



Stille modus
gedeactiveerd

Instelling van de Timer

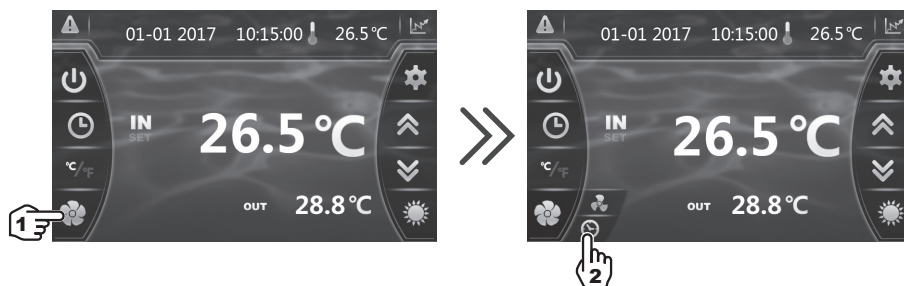

4. GEBRUIKERSINTERFACE (vervolg)

Instelling van de Timer (vervolg)

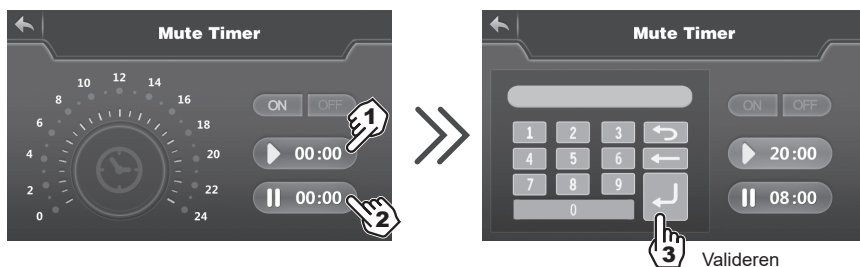

- 1) Starttijd, invoer en validering.
- 2) Eindtijd, invoer en validering.
- 3) Valideren.



- 4) Activering.
- 5) Deactivering.
- 6) Terug naar hoofdscherm,



Het instellingsinterval is van «van uur tot uur».
Als de Timer is geactiveerd, is deze 7 dagen per week actief.

5. ONDERHOUD EN OVERWINTERING

5.1 Onderhoud

1 keer per jaar moeten er onderhoudswerken plaatsvinden om de levensduur en een goede werking van de warmtepomp te kunnen garanderen.

- Poets de verdamper met een zachte borstel, een luchtstraal of met water **Opgelet, gebruik nooit een hogedrukreiniger**).
- Controleer of de condensaten goed afgevoerd worden.
- Controleer of de elektrische en hydraulische aansluitingen goed afsluiten.
- Controleer de hydraulische dichting van de condensor.
- De waterdichtheid van het koelcircuit **door een erkende professional** laten controleren met een lekdetector.



Voor ieder onderhoud moet de warmtepomp ontkoppeld worden van elke elektrische bron. Onderhoud mag enkel door een gekwalificeerde en bevoegde installateur gebeuren die gewend is met koelmiddelen om te gaan.

5.2 Overwintering

- Zet de warmtepomp in Modus "OFF".
- Ontkoppel de voeding van de warmtepomp.
- Maak de condensor leeg met behulp van de aflatopening om schade te vermijden. (belangrijk risico bij bevriezing).
- Sluit de "by-pass"-klep af en schroef de aansluitingen op de in-/uitlaat los.
- Voer het resterende water in de condensor door middel van een luchtpistool af.
- Sluit de watertoevoer en -afvoer van de warmtepomp af om te vermijden dat vreemde voorwerpen binnendringen.
- Bedek de warmtepomp met de meegeleverde overwinteringshoes.



Eender welke schade veroorzaakt door een slechte overwintering, zorgt ervoor dat de garantie geannuleerd wordt.

6. BIJLAGEN

6.1 Elektrische schema's

ENPI4M

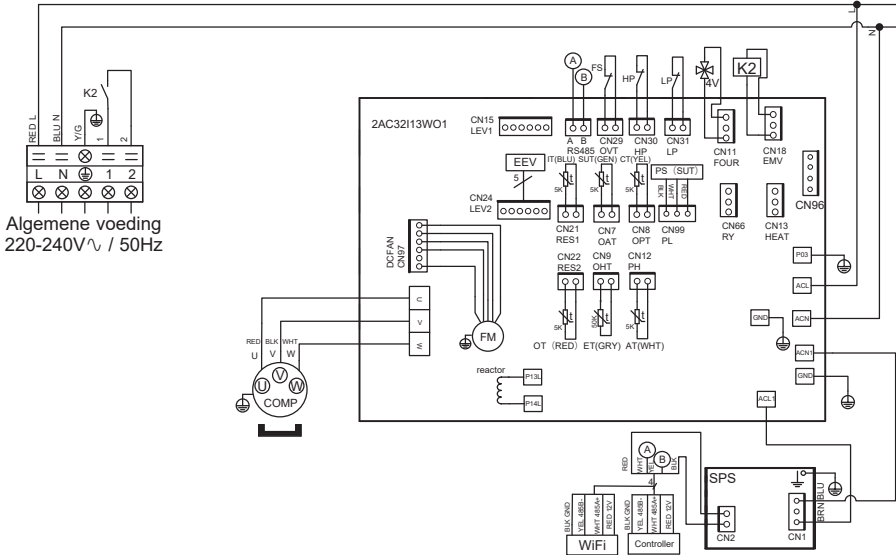

OPMERKINGEN

- | | |
|--|---|
| <p>AT : LUCHTTEMPERATUURSENSOR</p> <p>COMP : COMPRESSOR</p> <p>CT : CONDENSATIETEMPERATUUR SENSOR</p> <p>EEV : ELEKTRONISCHE DRUKREGELAAR</p> <p>FM : VENTILATORMOTOR</p> <p>FS : WATERDETECTOR</p> <p>HP : HOGEDRUKSCHAKELAAR</p> <p>IT : TEMPERATUURSENSOR VOOR BINNENKOMEND WATER</p> | <p>LP : LAGEDRUKSCHAKELAAR</p> <p>OT : TEMPERATUURSENSOR VOOR BUITENGAAND WATER</p> <p>SUT : AANZUIGTEMPERATUURSENSOR</p> <p>4V : 4-WEGSKRAAN</p> <p>K2 : VOLTVRIJ CONTACT MAX 16 A</p> <p>ET : TEMPERATUURSENSOR OPSTUWING</p> <p>PS : DRUKSENSOR</p> |
|--|---|

6. BIJLAGEN (vervolg)

ENPI6M

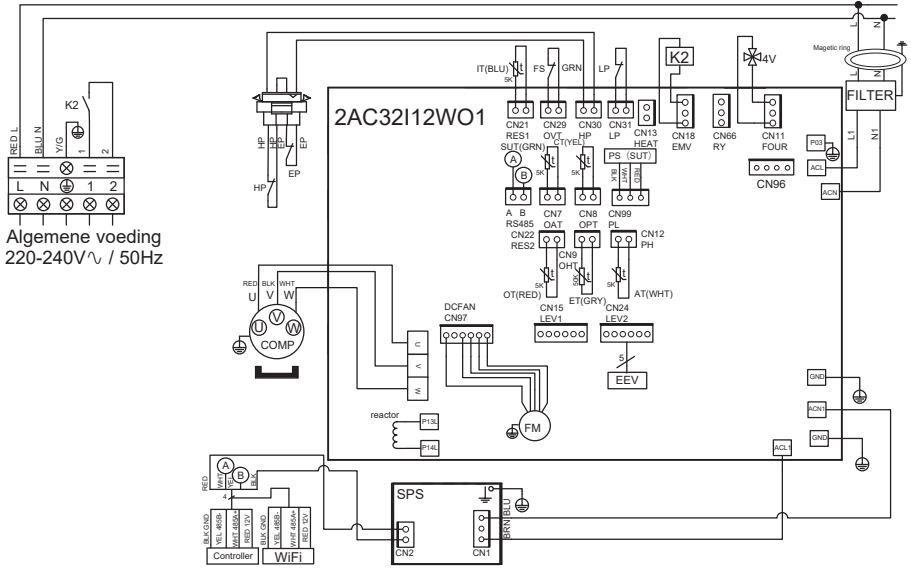

OPMERKINGEN

- | | |
|--|---|
| AT : LUCHTTEMPERATUURSSENSOR | LP : LAGEDRUKSCHAKELAAR |
| COMP : COMPRESSOR | OT : TEMPERATUURSSENSOR VOOR BUITENGAAND WATER |
| CT : CONDENSATIETEMPERATUUR SENSOR | SUT : AANZUIGTEMPERATUURSSENSOR |
| EEV : ELEKTRONISCHE DRUKREGELAAR | 4V : 4-WEGSKRAAN |
| FM : VENTILATORMOTORR | K2 : VOLT VRIJ CONTACT MAX 16 A |
| FS : WATERDETECTOR | ET : TEMPERATUURSSENSOR OPSTUWING |
| HP : HOGEDRUKSCHAKELAAR | PS : DRUKSENSOR |
| IT : TEMPERATUURSSENSOR VOOR BINNENKOMEND WATER | |

6. BIJLAGEN (vervolg)

6.2 Aansluitingen prioriteit verwarming eenfasepomp

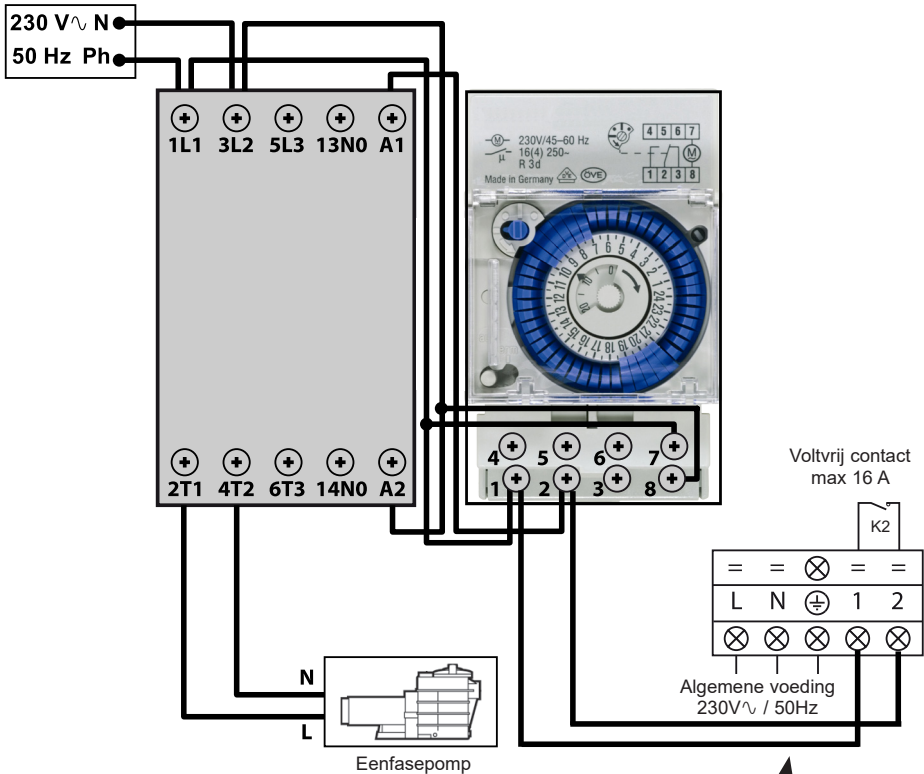

De zuilen 1-2 leveren een spanningvrij contact, zonder polariteit 230 V \sim / 50 Hz.

Sluit de zuilen 1 en 2 met kabels aan zoals op het schema hierboven is aangegeven zodat de werking van de filterpomp wordt ingesteld op een cyclus van 2 minuten per uur als de temperatuur van het bassin lager is dan aanbevolen.

 De voeding van de filterpomp nooit direct aansluiten op de zuilen 1 en 2.



Opzettelijk leeg gelaten pagina

6. BIJLAGEN (vervolg)

6.3 Opengewerkte tekeningen en onderdelen

ENPI4M / ENPI6M

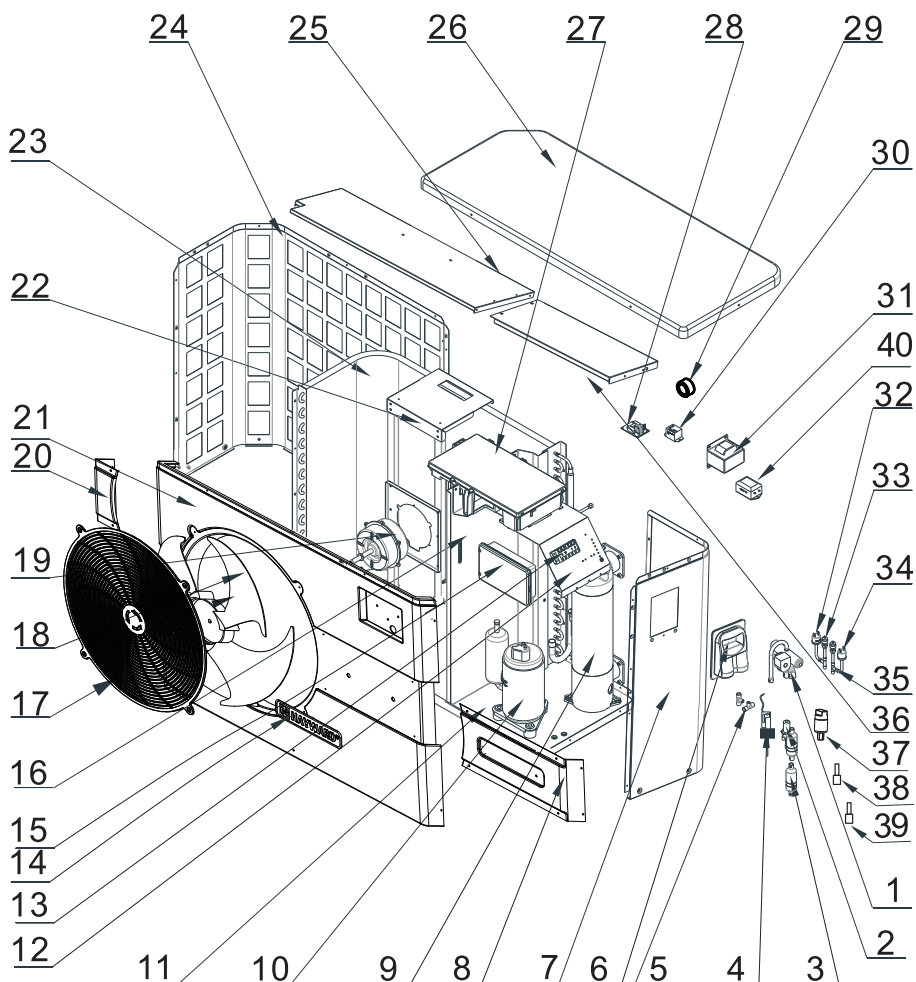

6. BIJLAGEN (vervolg)

ENPI4M / ENPI6M

Nr.	Omschrijving	Ref.	ENPI4M	ENPI6M
1	4-wegskraan	HWX20041437	✓	✓
2	Elektronisch reduceerventiel	HWX81000015	✓	n/a
		HWX81000016	n/a	✓
3	Filter ø9.7-ø9.7 (Ø28)	HWX20041444	✓	✓
4	Detector waterdebiet	HWX83000012	✓	✓
5	T-schakelaar ø9.52-2 x ø6.5(T) x 1.0	HWX30403000002	✓	✓
6	Elektrische toegangsopening	HWX320922029	✓	✓
7	Rechterpaneel	HWX80700455	✓	✓
8	Decoratief paneel rechts	HWX80900089	✓	✓
9	Titaancondensator/pvc	HWX80600074	✓	n/a
		HWX80600096	n/a	✓
10	Compressor	HWX20000110448	✓	n/a
		HWX80100003	n/a	✓
11	/	/	/	/
12	/	/	/	/
13	Aansluitblok L-N-GND -5 aansluitingen 4mm ²	HWX40003901	✓	✓
14	Logo HAYWARD	HWX20000230596	✓	✓
15	Tactiel kleurenscherm	HWX95005310612	✓	✓
16	/	/	/	/
17	Beschermingsrooster ventilator	HWX20000220169	✓	✓
18	Ventilatorblad	HWX20000270004	✓	✓
19	Motor ventilator DC	HWX20000330132	✓	✓
20	Decoratief paneel links	HWX80900088	✓	✓
21	Paneel Voor	HWX80900087	✓	✓
22	Motorsteun	HWX80700248	✓	✓
		HWX80600044	✓	n/a
23	Verdamper met lamellen	HWX80600100	n/a	✓
24	Linkerpaneel	HWX80700455	✓	✓
25	/	/	/	/
26	Paneel bovenaan	HWX301090200806	✓	✓
		HWX82300008	✓	n/a
27	Elektronische driver-kaart	HWX82300007	n/a	✓
		HWX82600008	✓	✓
28	Transformator 230V~/12VDC	HWX82600008	✓	✓
29	/	/	/	/
30	Relais K2	HWX20000360297	✓	✓
31	Spoel 20A 50Hz 5mH	HWX82500005	✓	✓
32	Drukregelaar lage druk NO 0.30MPa/0.15MPa	HWX20000360157	✓	✓
33	Drukafsluiter 40mm 1/2"	HWX20000140150	✓	✓
34	Drukregelaar hoge druk NC 3.2MPa/4.4MPa	HWX20013605	✓	✓
35	T-schakelaar ø6.5-2 x ø6.5(T) x 0.75T2M	HWX20001460	✓	✓
36	/	/	/	/
37	Druksensor	HWX20000360123	✓	✓
38	Compressor ontlading sonde 50 kΩ-660mm	HWX83000026	✓	✓
39	Luchttemperatuursonde 5k-350mm	HWX83000049	✓	✓
	Waterafvoer sonde 5k-410mm	HWX83000050	✓	✓
	Sensor voor binnenkomend water 5k-850mm	HWX83000052	✓	✓
	Aspiratiesonde compressor 5k-560mm	HWX83000044	✓	✓
	Ontdooisensor 5k-680mm	HWX83000051	✓	✓
40	EMC filter	HWX20003257	n/a	✓

6. BIJLAGEN (vervolg)

6.4 Gids voor het probleemoplossing



Sommige handelingen mogen enkel door een bevoegd techniker uitgevoerd worden.

In geval van een defect van de warmtepomp, verschijnt het rood knipperende symbool  in de linkerhoek van het scherm.

Op het symbool  drukken om naar de foutenlijst te gaan.

In geval van een defect, worden de volgende indicaties op het scherm weergegeven:

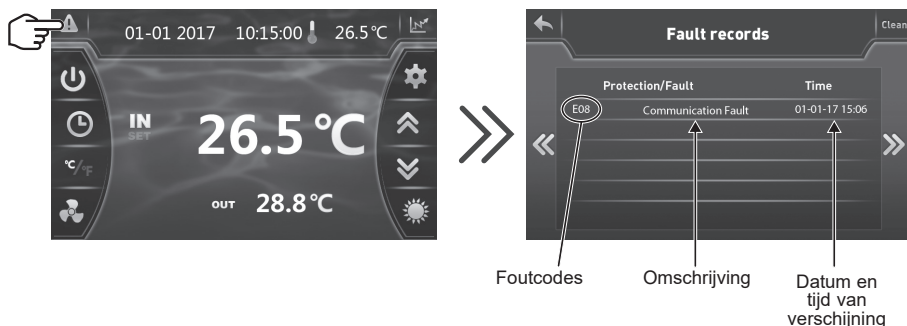

Nadat het probleem is opgelost, wordt de fout automatisch afgewerkt, de driehoek wordt grijs.



*Om de foutenlijst te wissen, op **Clean** drukken en terug gaan naar het vorige scherm door op  te drukken.*

6. BIJLAGEN (vervolg)

Probleem	Foutcodes	Omschrijving	Oplossing
Inlaat watertemperatuur sensor fout	P01	De sensor is open of in kortsluiting	Controleer de CN21/RES1-connector op de printplaat en verleng of vervang de sensor.
Uitlaat watertemperatuur sensor fout	P02		Controleer de N22/RES2-connector op de printplaat en verleng of vervang de sensor.
Omgevingstemperatuursensor fout	P04		Controleer de CN12/PH-connector op de printplaat en verleng of vervang de sensor.
Ontdooisensor fout	P05		Controleer de CN8/OPT-connector op de printplaat en verleng of vervang de sensor.
Defect aspiratiesonde compressor	P07		Controleer de CN7/OAT-connector op de printplaat en verleng of vervang de sensor.
Defect aanzuigsonde Compressor	P081		Controleer de CN9/OHT-connector op de printplaat en verleng of vervang de sensor.
Overdrukbescherming	E01	De sensor is open of in kortsluiting	<p>Controleer de CN30 / HP-connector op het bord of vervang de sensor</p> <p>Waterdebiet controleren</p> <p>Waterdebietdetector controleren</p> <p>Opening van de kleppen controleren</p> <p>Bypass controleren</p> <p>De verdamper op vervuiling controleren</p> <p>Te hoge watertemperatuur</p> <p>Probleem met niet-condenseerbare stoffen, verwijder vloeistof en lucht uit het koelcircuit</p> <p>Te veel vloeistof aanwezig, verwijder de vloeistof in een fles</p>
Onderdrukbescherming	E02	De sensor is open of in kortsluiting	<p>De AI/DI03 aansluiting op de kaart controleren of de sensor vervangen</p> <p>Controleer de lagedrukregelaar en de druk van het koelcircuit om na te gaan of er een lek is.</p> <p>Te laag luchtdebiet, de rotatiesnelheid van de ventilator controleren</p> <p>De verdamper op vervuiling controleren</p>
Debietmeter fout	E03	De sensor is open of in kortsluiting	<p>De AI/DI02 aansluiting op de kaart controleren of de sensor vervangen</p> <p>Te weinig water, de werking van de filterpomp controleren</p> <p>Opening van de stopkleppen controleren</p> <p>Bypass controleren</p>

6. BIJLAGEN (vervolg)

Probleem	Foutcodes	Omschrijving	Oplossing
Temperatuurverschil tussen Aanvoer/ Afvoer > 13°C	E06	Alleen in Koude modus toepasbaar	De warmtepomp stoppen, de werking van de filterpomp controleren
			Opening van de stopkleppen controleren
			Bypass controleren
Antivriesbescherming Koude Modus	E07	Temperatuur waterafvoer < 4°C	De warmtepomp stoppen, de condensator leegmaken, risico op bevroering
Debietmeter fout	E08	Geen communicatie tussen de elektronische kaart en de gebruikersinterface	Aansluitingen en connectoren controleren - zie elektrisch schema
Antivriesbescherming van niveau 1	E19	< 2°C Watertemperatuur < 4° en luchttemperatuur < 0°	Schakel de warmtepomp uit, maak de condensator leeg om bevroering te voorkomen, de pomp start standaard de filterpomp om bevroering te voorkomen
Antivriesbescherming van niveau 2	E29	Watertemperatuur < 2° en luchttemperatuur < 0°	Schakel de warmtepomp uit, maak de condensator leeg om bevroering te voorkomen, de pomp start standaard de filterpomp en de warmtepomp om bevroering te voorkomen.
Fout in de ventilatormotor	F031	Motor geblokkeerd of verbinding mislukt	Controleer de vrije rotatie; controleer het CN97/DCFan-aansluitsysteem; vervang de motor.
Fout in de ventilatormotor	F051	Verbindingsfout	DCFAN/CN97-aansluiting controleren; motor vervangen
Buitentemperatuur te laag	TP	Bedrijfslimiet bereikt	Warmtepomp uitschakelen
Defect druksensor	PP	De sensor is open of in kortsluiting	De aansluitingen controleren (zie elektrisch schema)

6. BIJLAGEN (vervolg)

6.5 Registratiebasis

Druk op het hoofdscherm op  om naar de gegevenshistoriek van de temperaturen van de wateraanvoer en -afvoer te gaan.



Deze gegevens zijn 60 dagen beschikbaar.

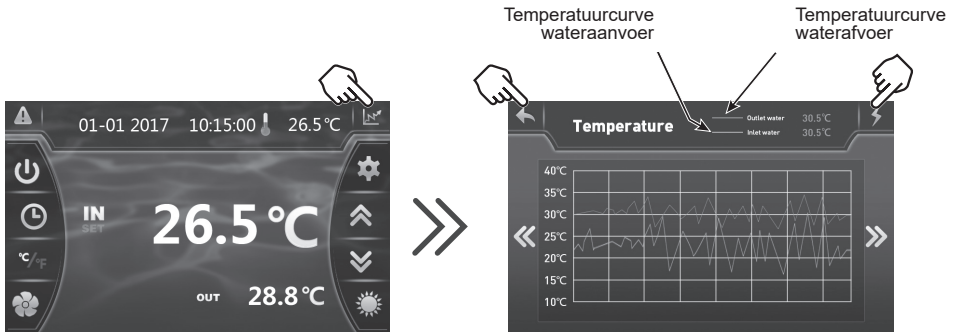

Druk op  om naar het gemiddeld verbruikte elektriciteitsvermogen te gaan.

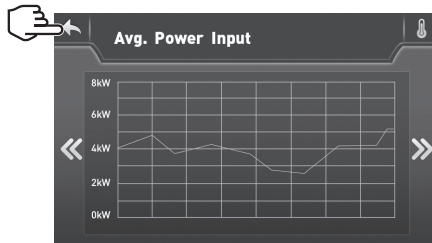

Druk op  om terug te gaan naar het vorige scherm.

6. BIJLAGEN (vervolg)

6.6 Garantie

GARANTIEVOORWAARDEN

Alle HAYWARD-producten vallen onder garantie in geval van fabrieks- of materiaalfouten gedurende twee jaar vanaf de aankoopdatum. Elke garantieaanvraag moet samen met een aankoopbewijs met datum ingediend worden. Wij dringen er dus op aan dat u uw factuur bewaart. De HAYWARD-garantie is beperkt tot reparatie of vervanging, bepaald door HAYWARD, van de defecte toestellen zolang ze op een normale wijze en volgens de voorschriften die in de handleiding vermeld, gebruikt zijn, het apparaat niet aangepast is en enkel gebruikt is in met HAYWARD componenten en onderdelen. Schade veroorzaakt door vrieskou en chemische agensen vallen niet onder garantie. Alle andere kosten (transport, werkuren...) worden niet door de garantie gedekt.

HAYWARD kan niet verantwoordelijk gesteld worden voor eender welke directe of indirecte schade veroorzaakt tijdens de installatie, aansluiting of onjuist gebruik van een product.

Om een garantie aan te vragen en herstel of vervanging van een product te eisen, moet u zich tot uw verdeler wenden. Wij zullen geen enkele retour naar de fabriek aanvaarden zonder een vooraf bekomen schriftelijke goedkeuring. Slijtage valt niet onder garantie.

ISENPINVR32

ENERGYLINE PRO iNVERTER

UNITÀ DI RISCALDAMENTO A POMPA DI CALORE PER PISCINE



Manuale d'Uso e di Installazione

INDICE

1. INTRODUZIONE	1
2. SPECIFICHE TECNICHE	4
2.1 Prestazioni dell'Unità di Riscaldamento a Pompa di Calore per Piscine	4
2.2 Soglie di funzionamento	5
3. INSTALLAZIONE E COLLEGAMENTO	7
3.1 Schema di principio	7
3.2 Pompa di calore	7
3.3 Collegamento idraulico	8
3.4 Collegamento Elettrico	9
3.5 Primo avviamento	10
3.6 Regolazione della portata d'acqua	12
4. INTERFACCIA UTENTE	13
4.1 Presentazione generale	13
4.2 Impostazione di Data e Ora	14
4.3 Configurazione della funzione timer	14
4.4 Configurazione e visualizzazione set point	16
4.5 Blocco e sblocco del touch screen	17
4.6 Configurazione della funzione SILENCE	18
5. MANUTENZIONE E SVERNAMENTO	21
5.1 Manutenzione	21
5.2 Svernamento	21
6. APPENDICI	22
6.1 Schemi Elettrici	22
6.2 Collegamenti priorità riscaldamento pompa monofase	24
6.3 Esplosi e parti di ricambio	26
6.4 Guida alla Risoluzione dei Problemi	28
6.5 Base di rilevamento	31
6.6 Garanzia	32

Leggere attentamente e riporre in luogo facilmente accessibile per la consultazione.

La presente documentazione deve essere consegnata al proprietario della piscina, il quale dovrà conservarla in un luogo sicuro.

1. INTRODUZIONE

Vi ringraziamo per aver acquistato la nostra pompa a calore per piscina Hayward. La pompa a calore Hayward FULL INVERTER è stata appositamente studiata secondo severe norme di fabbricazione, allo scopo di fornire il più elevato livello di qualità possibile.

Le pompe a calore Hayward vi offriranno eccezionali prestazioni durante tutta la stagione dei bagni adattando la potenza, i consumi elettrici ed il livello acustico alle esigenze di riscaldamento della vostra piscina, grazie al circuito logico di controllo FULL INVERTER.



Leggere attentamente le istruzioni contenute in questo manuale prima dell'uso

Le pompe a calore Hayward sono esclusivamente destinate al riscaldamento dell'acqua della piscina. Non vanno usate per altri scopi.

Il presente manuale contiene tutte le informazioni necessarie riguardo all'installazione, alla risoluzione delle anomalie e alla manutenzione della pompa.

Leggere attentamente il manuale prima di aprire la pompa o di effettuare operazioni di manutenzione sulla stessa. Il costruttore della pompa non sarà ritenuto in alcun caso responsabile di eventuali danni fisici subiti da un utente o di eventuali danni subiti dal materiale in seguito ad errori d'installazione, a tentativi di risoluzione di anomalie o ad interventi di manutenzione inutili. Vanno sempre rispettate le istruzioni contenute nel manuale

Il mancato rispetto delle istruzioni annulla la garanzia.

INTRODUZIONE (segue)



Istruzioni di sicurezza



Questo apparecchio contiene R32.

Non usare mai un refrigerante diverso dall'R32. La miscela di altri corpi gassosi con l'R32 rischia di provocare pressioni anormalmente elevate che possono causare guasti o rotture dei tubi e danni fisici alle persone

Non usare mai, durante le riparazioni o le operazioni di manutenzione, tubi di rame dotati di spessore inferiore a 0,8 mm.

La pompa a calore è sotto pressione: occorre, pertanto, evitare, in qualunque caso, di forare i tubi o di effettuare giunzioni brasate. Rischio di esplosione.

Non esporre l'apparecchio alle fiamme, alle scintille o ad altre sorgenti di combustione. La pompa potrebbe esplodere provocando ferite gravi o addirittura mortali.

- Quando non viene usata, la pompa a calore va riposta in un locale sufficientemente ventilato, dotato di una superficie al suolo di A_{\min} (m²) calcolata secondo la seguente formula : $A_{\min} = (M/(2.5 \times 0.22759 \times h_0))^2$
M corrisponde alla carica di refrigerante in kg contenuta nell'apparecchio, mentre h₀ corrisponde all'altezza di stoccaggio. Se la pompa viene riposta a livello del suolo h₀ = 0,6 m.
- La pompa a calore va installata esclusivamente all'esterno degli edifici.
- L'impianto va installato unicamente da personale qualificato.
- Non installare la pompa a calore su un supporto suscettibile di amplificare le vibrazioni prodotte dalla stessa.
- Verificare che le dimensioni del supporto previsto per l'impianto siano adeguate rispetto al peso dell'apparecchiatura
- Non installare la pompa in un luogo suscettibile di amplificarne il livello acustico o in cui il rumore prodotto dall'impianto rischi di disturbare i vicini.
- L'allacciamento elettrico va effettuato da un elettricista qualificato, secondo le norme vigenti nel paese in cui è installata la pompa cfr. § 3.4.
- Staccare l'alimentazione principale e il sezionatore prima di effettuare qualunque intervento. Qualunque distrazione può causare un'elettrocuzione.
- Prima di procedere all'installazione, verificare che il cavo di terra non sia tagliato o scollegato.

INTRODUZIONE (segue)

- Collegare e serrare correttamente il cavo d'alimentazione elettrica. Un collegamento non correttamente effettuato può danneggiare i componenti elettrici.
- L'esposizione della pompa a calore all'acqua o all'umidità può provocare un'elettrocuzione. State molto attenti.
- Se riscontrate un difetto o un'anomalia, non installate la pompa e chiamate immediatamente il rivenditore.
- La manutenzione e le diverse operazioni vanno effettuate con la frequenza e nei momenti consigliati dal manuale.
- Le riparazioni vanno effettuate da personale qualificato.
- Usare solo pezzi di ricambio originali.
- Non usare metodi di pulizia diversi da quello consigliato nel manuale.

Avvertenze importanti riguardo al refrigerante utilizzato

Questo prodotto contiene gas serra fluorurati regolamentati dal protocollo di Kyoto. Non sprigionare questo gas nell'atmosfera.

Tipo di refrigerante: R32

Valore GWP(1): 675, valore basato sulla quarta relazione del GIEC.

La quantità di refrigerante basata sulla regolamento n. 517/ 2014 (F-Gas) è indicata sulla piastrina segnaletica dell'apparecchiatura

La vigente normativa europea o locale potrà esigere ispezioni periodiche delle perdite/fughe. Per maggiori informazioni in merito, contattare il distributore locale.

(1) Potenziale di riscaldamento globale

2. SPECIFICHE TECNICHE

2.1 Prestazioni dell'Unità di Riscaldamento a Pompa di Calore per Piscine

Modelli	ENERGYLINE PRO INVERTER	ENPI4M	ENPI6M
Tensione di alimentazione	V	220V-240V ~ / 1ph / 50Hz	
Refrigerante	/	R32	
Carica	kg	0,50	0,65
Massa in tCO ₂ e	/	0,34	0,44
Frequenza di controllo delle perdite	/	Non obbligatoria, ma consigliata una volta all'anno	
Capacità di riscaldamento Min--Max ^(a)	kW	2,50--9,73	3,20--11,9
Potenza elettrica assorbita Min--Max ^(a)	kW	0,20--1,34	0,28--1,68
Corrente nominale di esercizio Min--Max ^(a)	A	1,33--6,02	1,34--7,32
COP Max--Min ^(a)	/	12,32--7,12	11,51--7,10
Capacità di riscaldamento Min--Max ^(b)	kW	1,71--7,60	2,70--9,70
Potenza elettrica assorbita Min--Max ^(b)	kW	0,27--1,49	0,44--1,88
COP Max--Min ^(b)	/	6,40--5,1	6,10--5,55
Corrente nominale ammissibile (CMS)	A	7,30	8,90
Calibro del fusibile	aM	8	10
Interruttore curva D	D	8	10
Corrente di avviamento	A	< CMS	< CMS
Allacciamento idraulico	mm	50mm	
Portata idrica nominale ^(a)	m ³ /h	4,20	5,10
Perdita di carica sull'acqua max	kPa	3,3	4,5
Compressore	/	DC Inverter Mitsubishi	DC Inverter Highly
Tipo	/	Doppio rotante	Doppio rotante
Quantità	/	1	
Resistenza di avvolgimento a 20°C	Ohm	1,91	0,788
Ventilatore	/	Assiale	
Quantità	/	1	
Diametro	mm	405	510
Numero di pale	/	3	
Motore	/	DC Inverter	
Quantità	/	1	1
Velocità di rotazione	giri/min.	500--700	500-650
Velocità modalità silenziosa	giri/min.	300	400
Livello di pressione acustica a 1 metro	dB(A)	33--41	33-41
Livello di pressione acustica a 10 metri	dB(A)	16--25	16--25
Dimensioni nette dell'unità (L-I-H)	mm	1046/400/768	
Peso	kg	53	65



(a) Aria asciutta 27°C – Umidità relativa 78% - Temperatura d'ingresso dell'acqua 26°C.

(b) Aria asciutta 15°C - Umidità relativa 71% - Temperatura d'ingresso dell'acqua 26°C.

2. SPECIFICHE TECNICHE (segue)

2.2 Soglie di funzionamento

Per assicurare un funzionamento sicuro ed efficiente, utilizzare la pompa di calore entro le seguenti soglie di temperatura e umidità.

	Modalità riscaldamento 	Modalità Raffreddamento 
Temperatura esterna	-12°C – +35°C	+7°C – +43°C
Temperatura acqua	+12°C – +40°C	+8°C – +40°C
Umidità relativa	< 80%	< 80%
Soglia di configurazione set point	+15°C – +32°C	+8°C – +32°C



Se la temperatura o l'umidità non soddisfano le suddette condizioni, è possibile che si verifichi l'intervento di dispositivi di sicurezza che impediscano alla pompa di calore di azionarsi.



Per evitare eventuali rischi di deterioramento dei liner la temperatura massima di riscaldamento è limitata a 32°C. Hayward declina ogni responsabilità in caso di uso a temperature superiori a +32°C.

2. SPECIFICHE TECNICHE (segue)

2.3 Dimensioni

Modelli:

ENPI4M / ENPI6M

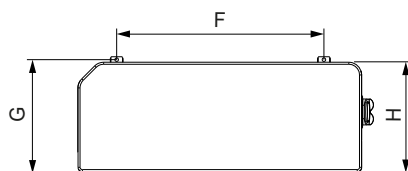
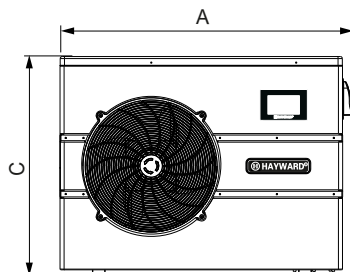
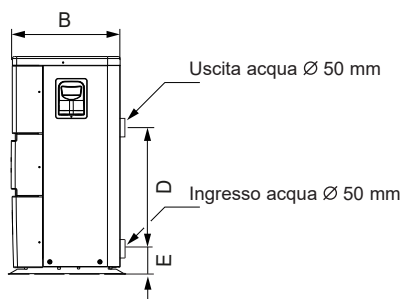

Unità : mm

Numerazione \ Modella	ENPI4M / ENPI6M
A	1046
B	400
C	768
D	350
E	110
F	615
G	428
H	400

3. INSTALLAZIONE E COLLEGAMENTO

3.1 Schema di principio

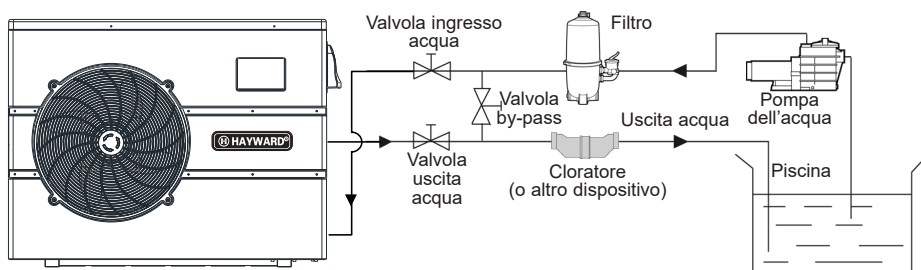

N.B.: L'unità fornita è priva di dispositivi di trattamento o di filtraggio. Gli elementi rappresentati nello schema devono essere forniti dall'installatore.

3.2 Pompa di calore



Installare l'Unità di Riscaldamento a Pompa di Calore per Piscine all'esterno e al di fuori di locali tecnici chiusi.

Installare l'unità in luogo riparato e rispettare le distanze minime sottoindicate, al fine di evitare il rischio di ricircolo dell'aria o eventuali diminuzioni delle prestazioni complessive dell'unità stessa.

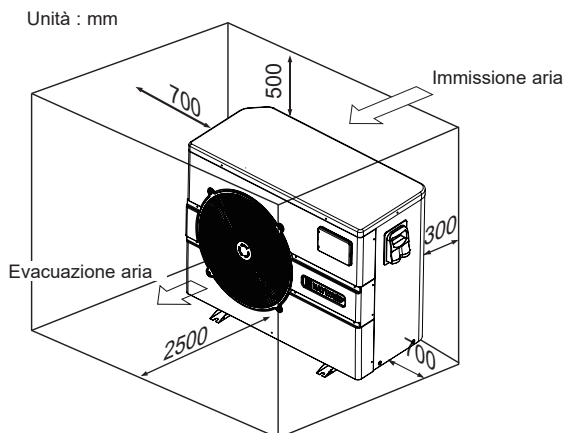

3. INSTALLAZIONE E COLLEGAMENTO (segue)



Preferibilmente, installare l'Unità di Riscaldamento a Pompa di calore su soletta in calcestruzzo alleggerito o su apposito supporto in metallo e montare l'unità sui silentblock in dotazione (bulloneria e rondelle non fornite).

Distanza max. tra l'unità e la piscina: 15 metri.

Lunghezza totale andata/ritorno tubazioni idrauliche: 30 metri.

Isolare le tubazioni idrauliche sia interrate che non interrate.

La pompa di calore deve essere installata a una distanza minima dalla vasca conforme alla norma NF C 15-100 (ossia, per la Francia, a 3,5 m dallo specchio d'acqua) o conforme alle norme relative all'installazione vigenti negli altri paesi.

Non installare la pompa di calore in prossimità di fonti di calore.

In caso d'installazione in regioni nevose, si consiglia di proteggere la macchina per prevenire un eventuale accumulo di neve sull'evaporatore.

3.3 Collegamento idraulico

L'unità è dotata di due raccordi di unione del diametro di 50 mm. Utilizzare tubi in PVC per tubazioni idrauliche Ø 50 mm. Collegare la tubazione per l'ingresso dell'acqua dell'unità alla conduttura proveniente dal gruppo di filtraggio, quindi collegare la tubazione per lo scarico dell'acqua alla conduttura utilizzata per immettere acqua nella piscina (cf. schema seguente).

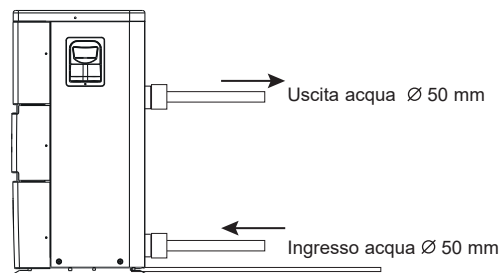

Installare una valvola by-pass tra l'ingresso e l'uscita dell'unità.



Se si utilizza un cloratore o un cloratore automatico, installare tale dispositivo dopo l'unità, al fine di proteggere il condensatore in Titanio da una concentrazione troppo elevata di prodotto chimico.



Per facilitare il drenaggio dell'unità durante la preparazione all'inverno e fornire facile accesso alle operazioni di smontaggio e manutenzione, si consiglia di installare la valvola by-pass e i raccordi di unione in dotazione in corrispondenza dell'ingresso e dell'uscita dell'unità.

3. INSTALLAZIONE E COLLEGAMENTO (segue)

3.4 Collegamento Elettrico



L'installazione elettrica e il cablaggio del presente dispositivo devono essere conformi alle norme d'installazione locali vigenti.

F	NF C15-100	GB	BS7671:1992
D	DIN VDE 0100-702	EW	EVHS-HD 384-7-702
A	ÖVE 8001-4-702	H	MSZ 2364-702/1994/MSZ 10-553 1/1990
E	UNE 20460-7-702 1993, RECBT ITC-BT-31 2002	M	MSA HD 384-7-702.S2
IRL	Wiring Rules + IS HD 384-7-702	PL	PN-IEC 60364-7-702:1999
I	CEI 64-8/7	CZ	CSN 33 2000 7-702
LUX	384-7.702 S2	SK	STN 33 2000-7-702
NL	NEN 1010-7-702	SLO	SIST HD 384-7-702.S2
P	RSIUEE	TR	TS IEC 60364-7-702



Assicurarsi che l'alimentazione elettrica disponibile e la frequenza di rete siano adeguate alla corrente operativa richiesta, tenendo in considerazione l'area di collocazione dell'unità e la corrente necessaria ad alimentare ogni altro dispositivo collegato allo stesso circuito.

ENPI4M 230V \sim +/- 10 % 50 Hz 1 Fase

ENPI6M 230V \sim +/- 10 % 50 Hz 1 Fase

Fare riferimento allo schema dell'impianto elettrico corrispondente in appendice.

La scatola di collegamento è posta sul lato destro dell'unità. Tre connessioni sono destinate all'alimentazione elettrica e due al comando della pompa di filtraggio (Asservimento).

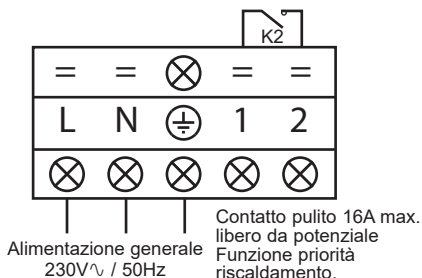

3. INSTALLAZIONE E COLLEGAMENTO (segue)



La linea di alimentazione elettrica deve essere opportunamente provvista di salvamotore tipo alimentazione motore (aM) o di interruttore curva D e interruttore differenziale 30mA (v. tabella seguente).

Modelli		ENPI4M	ENPI6M
Alimentazione elettrica	V/Ph/Hz	230V~ 50Hz	230V~ 50Hz
Calibro fusibile tipo aM	A	8 aM	10 aM
Interruttore curva D	A	8 D	10 D
Sezione cavo	mm ²	3G 2,5	3G 2,5



Utilizzare un cavo di alimentazione tipo RO 2V / R 2V o equivalente.





Le sezioni del cavo sono fornite per una lunghezza massima di 25 m, ma devono comunque essere controllate e adattate a seconda delle condizioni d'installazione.



Staccare sempre l'alimentazione principale prima di aprire la scatola elettrica.

3.5 Primo avviamento

Procedura di avviamento - dopo aver completato l'installazione, attenersi alla seguente procedura:

- 1) Ruotare manualmente i ventilatori per verificarne la libertà di movimento e per assicurarsi che l'elica sia correttamente fissata all'albero motore.
- 2) Assicurarsi che l'unità sia correttamente collegata alla fonte di alimentazione principale (v. schema dell'impianto elettrico in appendice).
- 3) Attivare la pompa di filtraggio.
- 4) Verificare che tutte le valvole dell'acqua siano aperte e che l'acqua fluisca nell'unità prima di avviare qualsiasi processo di riscaldamento o raffreddamento.
- 5) Verificare che la manichetta per lo scarico della condensa sia correttamente collegata e che non vi sia ostacolo al suo funzionamento.
- 6) Attivare l'alimentazione elettrica destinata all'unità, quindi premere il pulsante ON/OFF  sul pannello di controllo.
- 7) Controllare che il segnale d'allarme non () si accenda rosso. Se necessario, consultare la sezione relativa alla Risoluzione dei problemi (v. § 6.4).

3. INSTALLAZIONE E COLLEGAMENTO (segue)

- 8) Definire la portata dell'acqua agendo sulla valvola by-pass (v. § 3.6 e 2.1) secondo le indicazioni riportate sulla targhetta identificativa del modello, fino a ottenere una differenza nella temperatura dell'acqua in Ingresso/ Uscita di 2°C.
- 9) Dopo alcuni minuti di utilizzo, assicurarsi che l'aria in uscita sia più fredda (5-10°C).
- 10) Ad unità avviata, spegnere la pompa di filtraggio. L'unità si spegne automaticamente e viene visualizzato il codice errore E03.
- 11) Lasciare l'unità e la pompa piscina in funzione per 24 ore al giorno fino a quando l'acqua non raggiunge la temperatura desiderata. Quando la temperatura dell'acqua in ingresso raggiunge il valore predefinito, l'unità si spegne. L'unità si riavvia automaticamente (fino a quando la pompa della piscina rimane in funzione) quando la temperatura dell'acqua scende di 0,5°C rispetto alla temperatura impostata.

Interruttore di portata - L'unità è dotata di un interruttore di portata che ne regola l'accensione, quando la pompa di filtraggio della piscina è in funzione, e lo spegnimento, quando la pompa di filtraggio della piscina è fuori servizio. Se il livello dell'acqua è troppo basso, il codice d'allarme E03 viene visualizzato sul regolatore (v. § 6.4).

Temporizzazione - L'unità è dotata di un dispositivo di temporizzazione con ritardo di 3 minuti atto a proteggere i componenti del circuito di controllo e a prevenire avvii intempestivi e interferenze concernenti il contattore. Questa funzione riavvia automaticamente l'unità circa 3 minuti dopo ogni interruzione del circuito di controllo. Tale dispositivo si attiva anche in seguito a una breve interruzione di corrente.

3. INSTALLAZIONE E COLLEGAMENTO (segue)

3.6 Regolazione della portata d'acqua

Tenendo aperte le valvole, regolare la valvola by-pass in modo tale da ottenere una differenza di 2° C tra la temperatura dell'acqua in ingresso e la temperatura dell'acqua in uscita (v. schema di principio § 3.1). È possibile accertarsi della corretta regolazione verificando la temperatura dell'acqua in ingresso e in uscita visualizzata sul pannello di controllo.



N.B.: L'apertura della valvola by-pass genera una portata minore e un conseguente aumento del ΔT .
La chiusura della valvola by-pass genera una portata maggiore e una conseguente diminuzione del ΔT .

4. INTERFACCIA UTENTE

4.1 Presentazione generale

L'unità è dotata di un pannello di comando digitale touch screen collegato elettricamente e preimpostato in fabbrica in modalità riscaldamento.



Legenda

1		Allarme (rosso lampeggiante)
2		Schermo bloccato
3		Data
4		Ora
5		Temperatura esterna
6		Base di rilevamento (Temperatura acqua e potenza assorbita)
7		Letture impostazioni e dati salvati
8		Su / Aumenta
9		Giù / Riduci
10		Selezione della modalità di funzionamento
10a		Modalità Raffreddamento

10b		Modalità Riscaldamento
10c		Modalità automatica
11		Uscita acqua
12		Selezione modalità silenzioso
12a		Regolazione timer modalità silenzioso
12b		Spia modalità silenzioso e attivazione
13		Conversione °C/°F
14		Temperatura acqua in Ingresso
15		Impostazione data e ora Timer ON/OFF
16		Modalità sbrinatorio
17		ON/OFF

4. INTERFACCIA UTENTE (segue)

Modalità OFF

Quando l'unità è in stand-by (Modalità OFF), il pulsante è grigio. 

Modalità ON

Quando l'unità è in funzione o in fase di impostazione (Modalità ON) il pulsante si accende verde. 

4.2 Impostazione di Data e Ora



Torna alla schermata precedente 

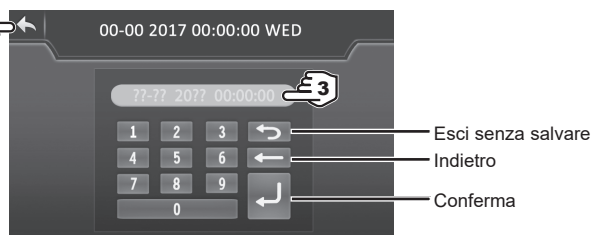

Compilare tutti i campi (Giorno/Mese/Anno, Ora/Minuto/Secondo) prima di confermare; in caso contrario le modifiche non saranno salvate.

4.3 Configurazione della funzione timer

La configurazione di questa funzione è necessaria se si desidera azionare l'unità per un periodo più breve rispetto a quello impostato tramite l'orologio che regola l'azionamento della pompa di filtraggio. In questo modo, è possibile ritardare l'avvio, anticipare l'arresto o impedire l'avviamento dell'unità durante una determinata fascia oraria (ad esempio di notte).

È possibile programmare fino a 1 Timer Partenza e 1 Timer Stop.

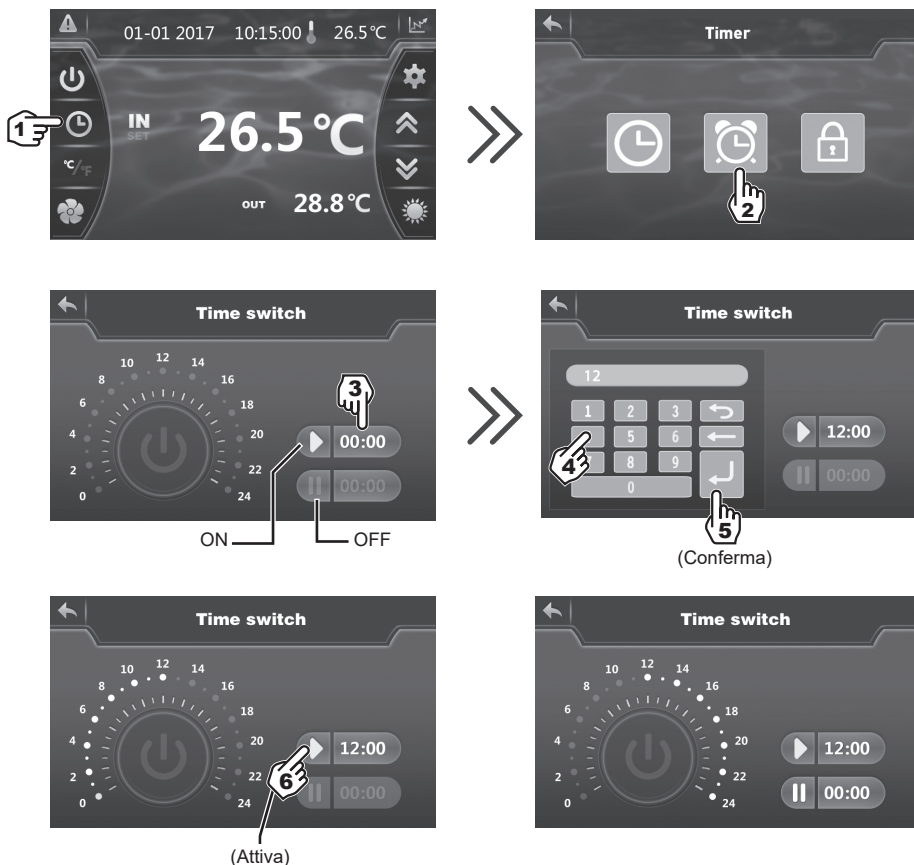

4. INTERFACCIA UTENTE (segue)



Evidenziato blu = Attivato
Grigio = Disattivato



Il passo di regolazione è «di ora in ora».

- Dopo aver impostato l'ora di inizio, toccare  (fase 6) per attivare il Timer. Il simbolo e l'ora vengono evidenziati in blu.
- Ripetere i passaggi da 3 a 6 per impostare e attivare l'ora di fine ( 00:00).
- Una volta terminate le regolazioni, l'intervallo di tempo in cui la pompa di calore è in funzione è evidenziato in verde, mentre l'intervallo di tempo in cui è ferma è evidenziato in giallo.
- Toccare 2 volte  per tornare alla schermata principale.

4. INTERFACCIA UTENTE (segue)

4.4 Configurazione e visualizzazione set point



In Modalità “OFF” e in Modalità “ON”

Visualizzare il set point premendo  , quindi impostare il set point desiderato premendo  o  .

Toccare  per confermare e tornare automaticamente alla schermata principale.



La configurazione viene effettuata con una precisione di regolazione di 0,5 °C.



Si raccomanda di non oltrepassare la temperatura di 30°C al fine di evitare di alterare i liner.

4. INTERFACCIA UTENTE (segue)



4.5 Blocco e sblocco del touch screen

Il display di controllo si blocca automaticamente dopo un minuto (impostazione predefinita).

L'intervallo di tempo necessario affinché lo schermo si blocchi automaticamente può essere impostato da 1 a 10 minuti, ma l'opzione può anche essere disattivata.



Blocco automatico attivo

- 3) Impostare l'intervallo di tempo su un valore compreso tra 1 e 10 minuti. Il salvataggio avviene automaticamente.
- 4) Per tornare alla schermata principale, toccare 2 volte .
- 5) Per disattivare il blocco automatico, toccare .

Per sbloccare lo schermo, tenere premuto (in qualsiasi punto) per 2 s.

Digitare il codice "22" e confermare toccando .



4. INTERFACCIA UTENTE (segue)

4.6 Configurazione della funzione SILENCE

La modalità silenzioso permette di usare la pompa di calore risparmiando energia e generando molto meno rumore quando le esigenze di riscaldamento sono ridotte (mantenimento della vasca a temperatura o necessità di avere un funzionamento ultrasilenzioso).

Attivazione Manuale



4. INTERFACCIA UTENTE (segue)

Disattivazione Manuale



Modalità Silenzioso
disattivata

Impostazione del Timer

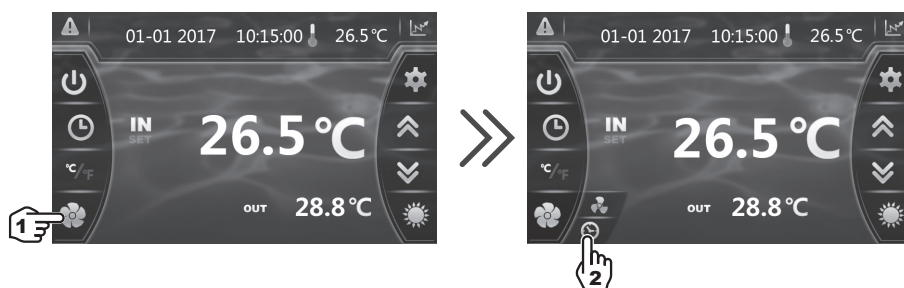

4. INTERFACCIA UTENTE (segue)

Impostazione del Timer (segue)

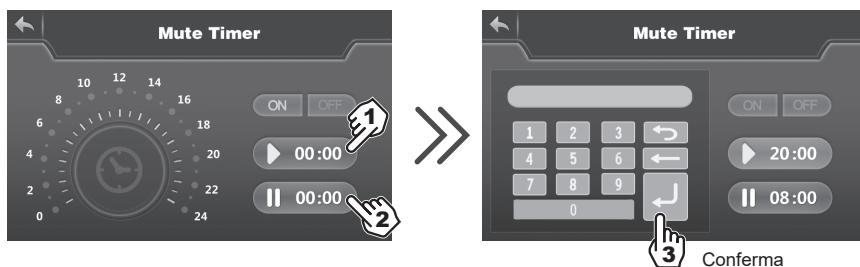

- 1) Ora di inizio, digitazione e conferma.
- 2) Ora di inizio, digitazione e conferma.
- 3) Conferma.



- 4) Attivazione.
- 5) Disattivazione.
- 6) Ritorno alla schermata principale.



Il passo di regolazione è "di ora" in ora».

Una volta attivato, il Timer rimane attivo 7 giorni su 7.

5. MANUTENZIONE E SVERNAMENTO

5.1 Manutenzione

Per garantire la longevità e il corretto funzionamento dell'Unità di Riscaldamento a Pompa di Calore per Piscine, le presenti operazioni di manutenzione devono essere effettuate 1 volta all'anno.

- Pulire l'evaporatore con una spazzola morbida, un getto di aria compressa o con acqua (**Attenzione: non utilizzare in nessun caso idropulitrici**).
- Controllare che lo scarico della condensa avvenga correttamente.
- Controllare che i collegamenti idraulici e quelli elettrici siano serrati correttamente.
- Controllare la tenuta idraulica del condensatore.
- Far controllare la tenuta del circuito frigorifero al rilevatore di perdite da un **professionista autorizzato**.



Prima di eseguire qualsiasi operazione di manutenzione, assicurarsi che l'unità sia scollegata da ogni fonte di corrente elettrica. Le operazioni di manutenzione devono essere effettuate esclusivamente da personale qualificato e abilitato alla manipolazione di fluidi frigoriferi.

5.2 Svernamento

- Mettere l'unità in Modalità "OFF".
- Interrompere l'alimentazione dell'unità.
- Svotare il condensatore tramite l'apposito scolo per evitare eventuali rischi di degrado. (elevato rischio di congelamento).
- Chiudere la valvola by-pass e svitare i raccordi di unione ingresso/uscita.
- Eliminare dal condensatore l'acqua stagnante residua servendosi di una pistola ad aria compressa.
- Ostruire l'ingresso e l'uscita dell'acqua dell'unità, al fine di evitare l'eventuale intrusione di corpi estranei.
- Coprire l'unità con l'apposito telo per l'inverno.



Una volta attivato, il Timer rimane attivo 7 giorni su 7.

6. APPENDICI

6.1 Schemi Elettrici

ENPI4M

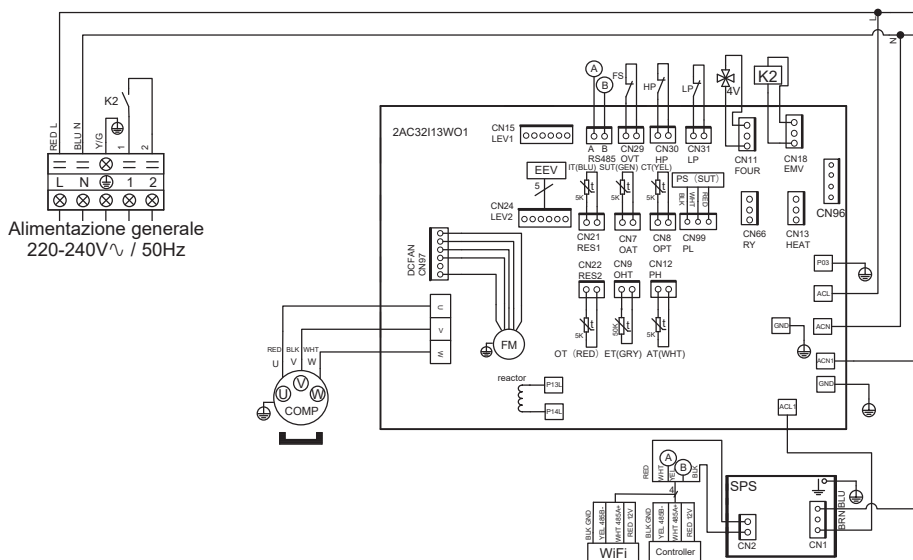

LEGENDA

- | | |
|---|--|
| AT : SONDA TEMPERATURA ARIA | LP : PRESSOSTATO BASSA PRESSIONE |
| COMP : COMPRESSORE | OT : SONDA TEMPERATURA ACQUA IN USCITA |
| CT : SONDA TEMPERATURA EVAPORATORE | SUT : SONDA TEMPERATURA ASPIRAZIONE |
| EEV : REGOLATORE DI PRESSIONE ELETTRONICO | 4V : VALVOLA 4 VIE |
| FM : MOTORE VENTOLA | K2 : CONTATTO PULITO LIBERO DA POTENZIALE 16A MAX. |
| FS : RILEVATORE ACQUA | ET : SONDA TEMPERATURA DI MANDATA |
| HP : PRESSOSTATO ALTA PRESSIONE | PS : SENSORE DI PRESSIONE |
| IT : SONDA TEMPERATURA ACQUA IN INGRESSO | |

6. APPENDICI (segue)

ENPI6M

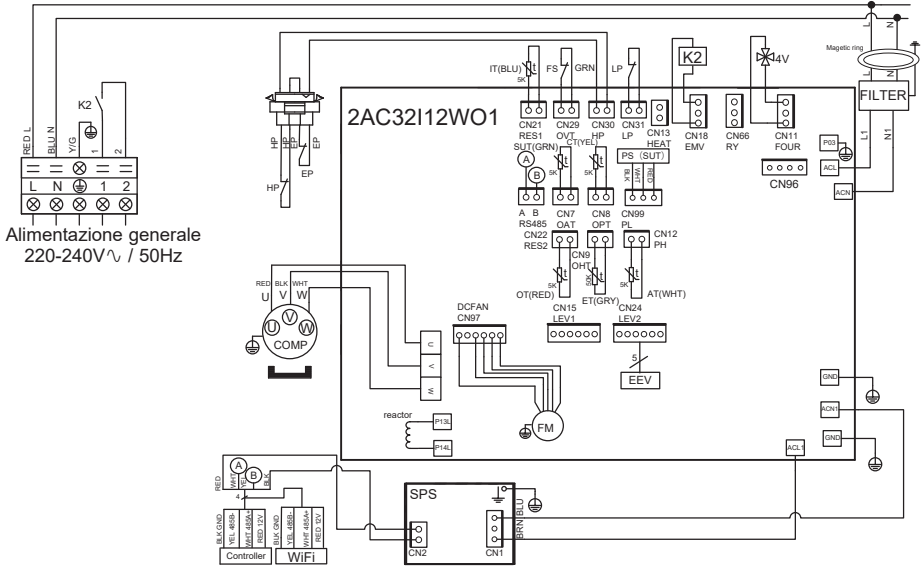

LEGENDA

- | | |
|--|---|
| AT : SONDA TEMPERATURA ARIA | LP : PRESSOSTATO BASSA PRESSIONE |
| COMP : COMPRESSORE | OT : SONDA TEMPERATURA ACQUA IN USCITA |
| CT : SONDA TEMPERATURA EVAPORATORE | SUT : SONDA TEMPERATURA ASPIRAZIONE |
| EEV : REGOLATORE DI PRESSIONE ELETTRONICO | 4V : VALVOLA 4 VIE |
| FM : MOTORE VENTOLA | K2 : CONTATTO PULITO LIBERO DA POTENZIALE 16A MAX. |
| FS : RILEVATORE ACQUA | ET : SONDA TEMPERATURA DI MANDATA |
| HP : PRESSOSTATO ALTA PRESSIONE | PS : SENSORE DI PRESSIONE |
| IT : SONDA TEMPERATURA ACQUA IN INGRESSO | |

6. APPENDICI (segue)

6.2 Collegamenti priorità riscaldamento pompa monofase

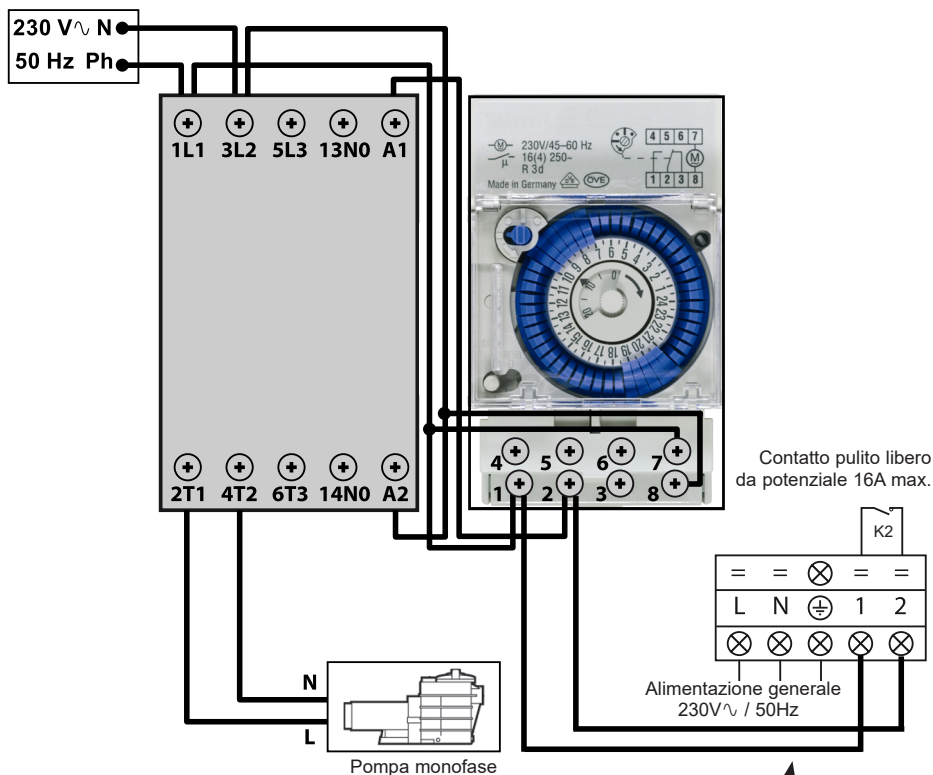

I morsetti 1 e 2 offrono un contatto pulito libero da potenziale, senza polarità 230 V \sim / 50 Hz.

Collegare i morsetti 1 e 2 come indicato nello schema di cablaggio di cui sopra per garantire il funzionamento della pompa di filtraggio per un ciclo di 2 min. ogni ora qualora la temperatura all'interno della vasca fosse inferiore al set point impostato.

 Non collegare l'alimentazione della pompa di filtraggio direttamente ai morsetti 1 e 2.



Pagina lasciata intenzionalmente bianca

6. APPENDICI (segue)

6.3 Esplosi e parti di ricambio

ENPI4M / ENPI6M

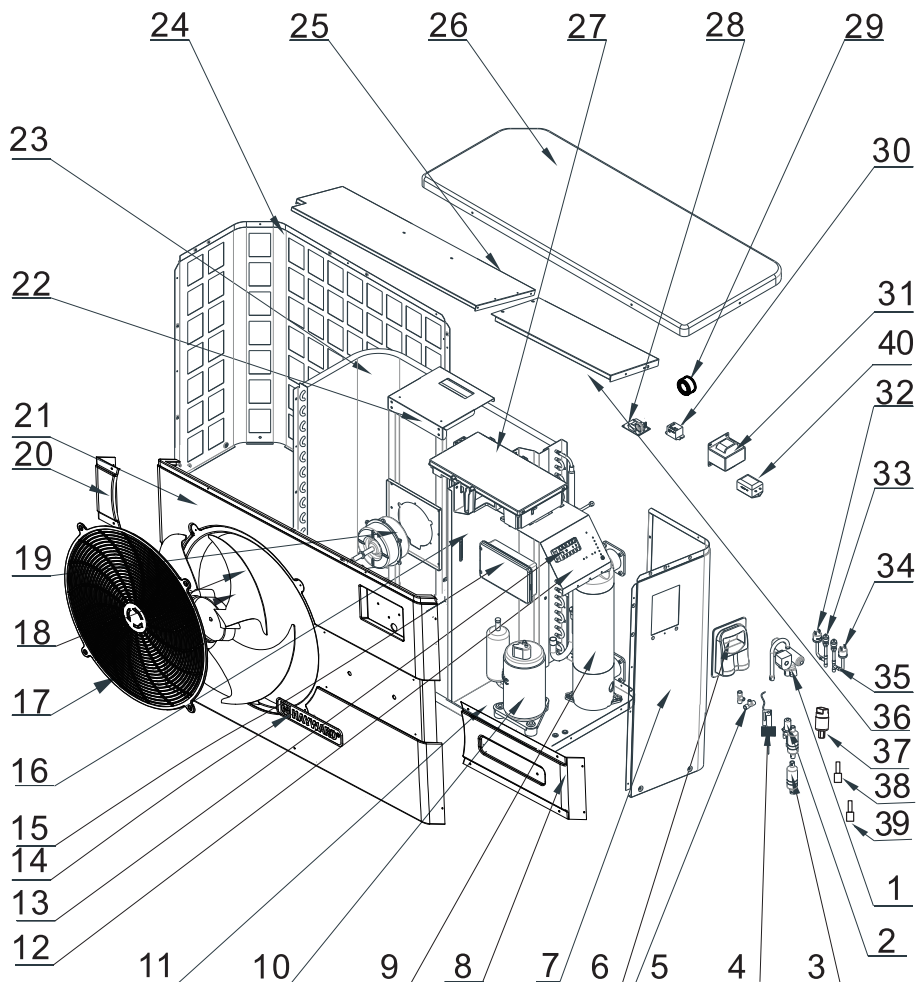

6. APPENDICI (segue)

ENPI4M / ENPI6M

Num.	Designazione	Rif.	ENPI4M	ENPI6M
1	Valvola 4 vie	HWX20041437	✓	✓
2	Riduttore di pressione elettronico	HWX81000015	✓	n/a
		HWX81000016	n/a	✓
3	Filtro ø9.7-ø9.7 (Ø28)	HWX20041444	✓	✓
4	Rilevatore portata acqua	HWX83000012	✓	✓
5	Connettore a T ø9.52-2 x ø6.5(T) x 1.0	HWX304030000002	✓	✓
6	Portello d'accesso scatola elettrica	HWX320922029	✓	✓
7	Pannello destro	HWX80700455	✓	✓
8	Pannello decorativo destro	HWX80900089	✓	✓
9	Condensatore Titanio/PVC	HWX80600074	✓	n/a
		HWX80600096	n/a	✓
10	Compressore	HWX20000110448	✓	n/a
		HWX80100003	n/a	✓
11	/	/	/	/
12	/	/	/	/
13	Morsettiera L-N-GND -5 connessioni 4mm ²	HWX40003901	✓	✓
14	Logo HAYWARD	HWX20000230596	✓	✓
15	Touch screen a colori	HWX95005310612	✓	✓
16	/	/	/	/
17	Griglia di protezione ventilatore	HWX20000220169	✓	✓
18	Elica ventilatore	HWX20000270004	✓	✓
19	Motore ventola DC	HWX20000330132	✓	✓
20	Pannello decorativo sinistro	HWX80900088	✓	✓
21	Pannello anteriore	HWX80900087	✓	✓
22	supporto motore	HWX80700248	✓	✓
		HWX80600044	✓	n/a
23	Evaporatore a piastre	HWX80600100	n/a	✓
24	Pannello sinistro	HWX80700455	✓	✓
25	/	/	/	/
26	Pannello superiore	HWX301090200806	✓	✓
27	Scheda elettronica Driver	HWX82300008	✓	n/a
		HWX82300007	n/a	✓
28	Trasformatore 230V~/12VDC	HWX82600008	✓	✓
29	/	/	/	/
30	Relè K2	HWX20000360297	✓	✓
31	Bobina 20A 50Hz 5mH	HWX82500005	✓	✓
32	Pressostato Bassa pressione NO 0.30MPa/0.15MPa	HWX20000360157	✓	✓
33	Rilevamento Pressione 40mm 1/2"	HWX20000140150	✓	✓
34	Pressostato Alta pressione NC 3.2MPa/4.4MPa	HWX20013605	✓	✓
35	Connecteur T ø6.5-2 x ø6.5(T) x 0.75T2M	HWX20001460	✓	✓
36	/	/	/	/
37	Sensore di Pressione	HWX20000360123	✓	✓
38	Sonda scarico compressore 50 kQ-660mm	HWX83000026	✓	✓
39	Sonda temperatura aria 5k-350mm	HWX83000049	✓	✓
	Sonda uscita acqua 5k-410mm	HWX83000050	✓	✓
	Sonda temperatura acqua in ingresso 5k-850mm	HWX83000052	✓	✓
	Sonda di aspirazione compressore 5k-560mm	HWX83000044	✓	✓
	Sonda antigelo 5k-680mm	HWX83000051	✓	✓
40	Filtro EMC	HWX20003257	n/a	✓

6. APPENDICI (segue)

6.4 Guida alla Risoluzione dei Problemi



Alcune delle presenti operazioni devono essere effettuate da un tecnico autorizzato.

In caso di guasto della pompa di calore, il simbolo  lampeggia rosso nell'angolo a sinistra dello schermo.

Toccare il simbolo  per accedere all'elenco degli errori.

In caso di problemi sullo schermo compaiono le seguenti indicazioni:

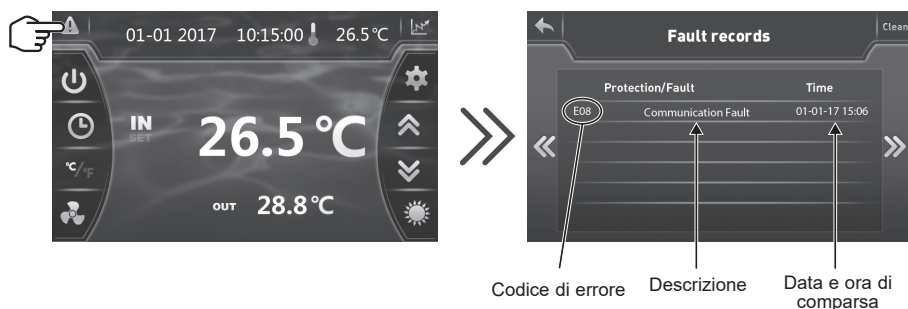

Una volta risolto il problema, lo stato dell'errore si aggiorna automaticamente e il triangolo diventa grigio fisso.



*Per cancellare l'elenco degli errori, toccare **Clean**, quindi tornare alla schermata precedente toccando .*

6. APPENDICI (segue)

Malfunzionamento	Codice errore	Descrizione	Soluzione
Guasto sonda temperatura acqua in ingresso	P01	Circuito aperto o cortocircuito	Verificare la connessione CN21/RES1 sulla scheda e il connettore prolunga oppure sostituire il sensore
Guasto sonda acqua in uscita	P02		Verificare la connessione N22/RES2 sulla scheda e il connettore prolunga oppure sostituire il sensore
Guasto sonda temperatura esterna	P04		Verificare la connessione CN12/PH sulla scheda e il connettore prolunga oppure sostituire il sensore
Guasto sonda antigelo	P05		Verificare la connessione CN8/OPT sulla scheda e il connettore prolunga oppure sostituire il sensore
Guasto sonda di aspirazione compressore	P07		Verificare la connessione CN7/OAT sulla scheda e il connettore prolunga oppure sostituire il sensore
Guasto sonda di mandata Compressore	P081		Verificare la connessione CN9/OHT sulla scheda e il connettore prolunga oppure sostituire il sensore
Protezione alta pressione	E01	Circuito aperto o cortocircuito	Verificare la connessione CN30/HP sulla scheda e il connettore prolunga oppure sostituire il sensore
			Controllare la portata d'acqua
			Controllare il sensore della portata d'acqua
			Controllare l'apertura delle valvole
			Controllare la valvola by-pass
			Controllare il livello di sporco dell'evaporatore
			Temperatura acqua troppo calda
			Problema incondensabile in seguito a manutenzione, svuotare e porre sottovuoto il circuito frigorifero
Carico fluido eccessivo, espellere il fluido in una bombola			
Protezione bassa pressione	E02	Circuito aperto o cortocircuito	Controllare i collegamenti AI/DI03 della scheda o sostituire il sensore
			Perdita rilevante di fluido frigorifero, cercare la perdita con il rilevatore
			Portata aria troppo bassa, controllare la velocità di rotazione della ventola
			Controllare il livello di sporco dell'evaporatore e pulirne la superficie
Guasto sensore di portata	E03	Circuito aperto o cortocircuito	Controllare i collegamenti AI/DI02 della scheda o sostituire il sensore
			Manca acqua, controllare che la pompa di filtrazione funzioni correttamente
			Controllare che le valvole di arresto siano aperte
			Controllare la regolazione della valvola by-pass

6. APPENDICI (segue)

Malfunzionamento	Codice errore	Descrizione	Soluzione
Differenza di temperatura Ingresso/ Uscita > 13°C	E06	Applicabile solo in modalità Freddo	Manca acqua, controllare che la pompa di filtrazione funzioni correttamente
			Controllare che le valvole di arresto siano aperte
			Controllare la regolazione della valvola by-pass
Protezione antigelo Modalità raffreddamento	E07	Temperatura acqua in uscita < a 4°C	Interrompere il funzionamento della pompa di calore, spurgare il condensatore antigelo
Guasto nel circuito di comunicazione	E08	Assenza di comunicazione tra la scheda elettronica e l'interfaccia utente	Verificare i collegamenti e la connessione – vedi schema elettrico
Protezione antigelo livello 1	E19	2°< Temperatura acqua <4° e Temperatura aria <0°	Interrompere il funzionamento della pompa di calore, spurgare il condensatore antigelo, la pompa di calore avvia automaticamente la pompa di filtrazione per evitare il gelo
Protezione antigelo livello 2	E29	Temperatura acqua < a 2° e Temperatura aria < 0°	Interrompere il funzionamento della pompa di calore, spurgare il condensatore antigelo, la pompa di calore avvia automaticamente la pompa di filtrazione e la pompa di calore per evitare il gelo.
Anomalie motore ventilatore	F031	Motore bloccato o difetto di collegamento	Verificare la corretta rotazione; verificare la connessione CN97/DCFan; sostituire il motore
Anomalie motore ventilatore	F051	Difetto di collegamento	Verificare la connessione DCFAN/ CN97; sostituire il motore
Temperatura esterna troppo bassa	TP	Raggiungimento del limite di funzionamento	Fermare la pompa
Guasto sensore di pressione	PP	Circuito aperto o cortocircuito	Controllare i collegamenti (v. schema elettrico)

6. APPENDICI (segue)

6.5 Base di rilevamento

Partendo dalla schermata principale, toccare  per accedere alla cronologia dei rilevamenti delle temperature dell'acqua in entrata e in uscita.



I dati sono disponibili per 60 giorni.

Toccare  per accedere alla potenza elettrica media consumata.

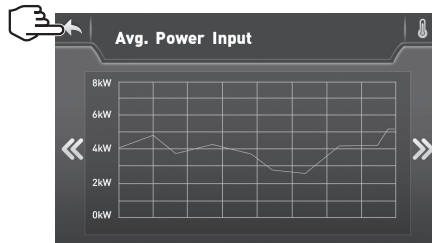
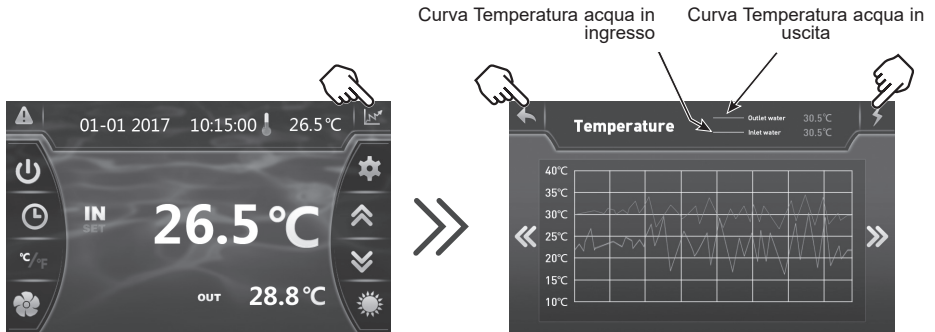

Toccare  per tornare alla schermata principale.

6. APPENDICI (segue)

6.6 Garanzia

CONDIZIONI DI GARANZIA

Tutti i prodotti HAYWARD sono garantiti contro tutti i difetti di fabbricazione o di materiale per un periodo di due anni dalla data di acquisto. Le eventuali richieste garanzia dovranno essere accompagnate dalla prova di acquisto comprovante detta data. Si raccomanda pertanto di conservare la fattura.

La garanzia HAYWARD è limitata alla riparazione o alla sostituzione, a discrezione della stessa HAYWARD, dei prodotti difettosi solo ed esclusivamente in caso di normale utilizzo e in conformità alle prescrizioni riportate nel manuale d'uso del prodotto; sarà altresì riconosciuta valida, qualora il prodotto in questione non sia stato in alcun caso alterato ed utilizzato esclusivamente in abbinamento a parti e componenti HAYWARD. Gli eventuali danni dovuti a gelo e ad attacchi di agenti chimici non sono coperti da garanzia.

Ogni altra spesa (trasporto, manodopera...) è esclusa dalla garanzia.

HAYWARD declina ogni responsabilità per danni, diretti o indiretti, riconducibili a installazione, collegamento o utilizzo non corretti del prodotto.

Per richiedere un intervento in garanzia e la riparazione o la sostituzione di un componente, rivolgersi ad un rivenditore autorizzato. Salvo previo accordo scritto, gli eventuali resi saranno respinti.

I componenti soggetti ad usura non sono coperti dalla garanzia.

ISENPINVR32

ENERGYLINE PRO INVERTER

VARMEPUMPE TIL SVØMMEBASSENG



Installerings- og brukerveiledning

INNHold

1. INNLEDNING	1
2. SPESIFIKASJONER	4
2.1 Varmepumpens ytelse	4
2.2 Driftsområde	5
2.3 Dimensjoner	6
3. INSTALLERING OG TILKOBLING	7
3.1 Skjematisk diagram	7
3.2 Varmepumpe	7
3.3 Vanntilkobling	8
3.4 Elektrisk tilkobling	9
3.5 Førstegangs oppstart	10
3.6 Innstilling av vannstrømmen	12
4. BRUKERGRENSESNITT	13
4.1 Oversikt	13
4.2 Justering av dato og klokkeslett	14
4.3 Innstilling av Timer	14
4.4 Innstilling og visning av settpunkt	16
4.5 Låse og låse opp berøringsskjermen	17
4.6 Innstilling av funksjon SILENCE	18
5. VEDLIKEHOLD OG VINTERKLARGJØRING	21
5.1 Vedlikehold	21
5.2 Vinterklargjøring	21
6. VEDLEGG	22
6.1 Koblingsskjemaer	22
6.2 Kobling med prioritet på enfaset varmpumpe	24
6.3 Sprengskisse og reservedeler	26
6.4 Veiledning for feilsøking	28
6.5 Lagringsbase	31
6.6 Garanti	32

1. INNLEDNING

Takk for at du har kjøpt denne Hayward varmpumpen til svømmebasseng. Hayward FULL INVERTER varmpumpe har blitt utformet i henhold til strenge produktionsstandarder for å oppfylle det høye kvalitetsnivået.

Hayward varmpumper vil gi deg enestående ytelser gjennom hele badesesongen ved at de tilpasser effekt, elektrisk forbruk og støynivå etter bassengets oppvarmingsbehov takket være kontrolllogikken FULL INVERTER.



Les instruksene i denne veiledningen nøye før du tar enheten i bruk.

Hayward varmpumper er kun forutsett til å varme opp bassengvann, og materialet må ikke brukes til andre bruksområder.

Denne brukerveiledningen inneholder all nødvendig informasjon vedrørende installasjon, feilretting og vedlikehold.

Les denne brukerveiledningen nøye før du åpner enheten eller utfører vedlikeholdsoperasjoner på den. Produsenten av dette produktet vil ikke i noen tilfeller bli holdt ansvarlig for skader på brukeren eller ødeleggelser på enheten som er en følge av feil ved installasjon, feilretting eller unødvendig vedlikehold. Det er svært viktig at instruksene i denne brukerveiledningen blir nøye fulgt på ethvert tidspunkt.

Alle anbefalinger som ikke etterkommes vil oppheve garantien.

INNLEDNING (fortsetter)



SIKKERHETSINSTRUKSER



Dette apparatet inneholder R32.

Det må ikke brukes noe annet kuldemedium enn R32. Enhver annen gass blandet med R32 kan føre til unormalt høye trykk som igjen kan forårsake feil eller eksplosjon av rørene samt personskade.

Ved reparasjon eller vedlikehold må R32 aldri brukes med kobberrør med en tykkelse på mindre enn 0,8 mm.

Da varmpumpen er under trykk må man aldri forsøke å stikke hull på eller lodde rørene. Det er fare for eksplosjon.

Apparatet må ikke utsettes for flammer, gnister eller andre antenningskilder. Det vil kunne eksplodere og føre til alvorlige skader eller død.

- Dersom varmpumpen skal lagres må den oppbevares i et godt ventilert lokale med et gulvareal på mer enn A_{\min} (m²) gitt med følgende formel:
$$A_{\min} = (M / (2.5 \times 0.22759 \times h_0))^2$$

M er mengden kuldemedium i apparatet i kg, og h₀ er lagringshøyden. For lagring på gulvet h₀ = 0,6 m.
- Varmepumpen er kun forutsett for å bli installert på utsiden av bygninger.
- Enheten må installeres av kvalifisert personell.
- Varmepumpen må ikke installeres på et underlag som risikerer å forsterke enhetens vibrasjoner.
- Sjekk at underlaget som er forutsett for enheten er riktig dimensjonert for vekten av apparatet.
- Varmepumpen må ikke installeres på et sted hvor støynivået vil kunne forsterkes, eller på et sted hvor støyen fra enheten vil kunne være til sjenanse for naboene.
- Alle elektriske tilkoplinger må utføres av en kvalifisert og godkjent elektriker og i henhold til gjeldende standarder i installasjonslandet jfr. § 3.4.
- Bryt hovedstrømtilførselen og skillebryteren før alt elektrisk arbeid. Dersom dette ikke blir gjort kan det forårsake elektrisk sjokk.
- Sjekk at jordledningen ikke er kuttet eller frakoplet før installasjon.

INNLEDNING (fortsetter)

- Kople til og stramme tilførselskabelen på riktig måte. Dersom forbindelsen er dårlig kan det føre til skade på de elektriske delene.
- Dersom varmpumpen utsettes for vann eller fuktig miljø, kan det føre til elektrisk sjokk. Utvis stor forsiktighet.
- Dersom du detekterer en feil eller en unormal situasjon, må ikke varmpumpen installeres, men ta umiddelbart kontakt med forhandleren.
- Vedlikeholdet og de ulike operasjonene må utføres med de anbefalte intervallene og på de anbefalte tidspunktene slik det er angitt i denne brukerveiledningen.
- Reparasjoner må utføres av kvalifisert personell.
- Bruk kun originale reservedeler.
- Det må aldri brukes en annen rengjøringsprosedyre enn den som fabrikanten har anbefalt.

Viktig informasjon angående det brukte kuldemediet.

Dette produktet inneholder fluorholdige klimagasser som er berammet av Kyoto-protokollen Disse gassene må ikke frigjøres i atmosfæren.

Kuldemedium: R32

GWP-verdi(1): 675, Verdi basert på den 4. rapporten fra IPCC.

Mengden kuldemedium basert på regelverket F Gaz 517/2014 er angitt på dataplatten på enheten.

Periodiske inspeksjoner av lekkasje av kuldemedium kan bli påkrevet avhengig av den europeiske eller lokale lovgivningen. Ta kontakt med din lokale forhandler for mer informasjon.

(1) Global warming potential (GWP))

2. SPESIFIKASJONER

2.1 Varmepumpens ytelse

Modeller	ENERGYLINE PRO INVERTER	ENPI4M	ENPI6M
Tilførselsspenning	V	220V-240V ~ / 1ph / 50Hz	
Kuldemedium	/	R32	
Last	kg	0,50	0,65
Masse i teqCO ₂	/	0,34	0,44
Hyppighet for lekkasjekontroll	/	Er ikke påkrevet, men årlig kontroll anbefales	
Oppvarmingskapasitet Min--Maks ^(a)	kW	2,50--9,73	3,20--11,9
Absorbert elektrisk effekt Min--Maks ^(a)	kW	0,20--1,34	0,28--1,68
Nominell strømverdi Min--Maks ^(a)	A	1,33--6,02	1,34--7,32
COP Maks--Min ^(a)	/	12,32--7,12	11,51--7,10
Oppvarmingskapasitet Min--Maks ^(b)	kW	1,71--7,60	2,70--9,70
Absorbert elektrisk effekt Min--Maks ^(b)	kW	0,27--1,49	0,44--1,88
COP Maks--Min ^(b)	/	6,40--5,1	6,10--5,55
Maksimum strømverdi	A	7,30	8,90
Sikringsstørrelse	aM	8	10
Effektbryter Kurve D	D	8	10
Startstrøm	A	< Maksimum strømverdi	< Maksimum strømverdi
Hydraulisk tilkopling	mm	50mm	
Nominell vannstrøm ^(a)	m ³ /h	4,20	5,10
Fall i vanntrykk (maks.)	kPa	3,3	4,5
Kompressor	/	Mitsubishi DC-omformer	Highly DC-omformer
Type	/	Dobbeltroterende	Dobbeltroterende
Antall	/	1	
Svingningsmotstand ved 20°C	Ohm	1,91	0,788
Vifte	/	Axial	
Antall	/	1	
Diameter	mm	405	510
Antall rotor	/	3	
Motor	/	DC-omformer	
Antall	/	1	1
Rotasjonshastighet	Omdr/min	500--700	500-650
Hastighet i Silent Mode	Omdr/min	300	400
Lydtrykknivå ved 1 m	dB(A)	33--41	33-41
Lydtrykknivå ved 10 m	dB(A)	16--25	16--25
Enhetens dimensjoner, netto (L-I-H)	mm	1046/400/768	
Vekt	kg	53	65



(a) Tørrluft 27°C – Relativ fuktighet 78% - Temperatur til vanninnløp 26°C.

(b) Tørrluft 15°C – Relativ fuktighet 71% - Temperatur til vanninnløp 26°C.

2. SPESIFIKASJONER (fortsetter)

2.2 Driftsområde

Bruk varmepumpen i de følgende temperatur- og fuktighetsområder for å sikre en trygg og effektiv drift.

	Oppvarmingsmodus 	Kjølemodus 
Utetemperatur	-12°C – +35°C	+7°C – +43°C
Vanntemperatur	+12°C – +40°C	+8°C – +40°C
Relativ luftfuktighet	< 80%	< 80%
Innstillingsområde for settpunkt	+15°C – +32°C	+8°C – +32°C



Hvis temperatur eller luftfuktighet ikke samsvarer med disse betingelsene, kan sikkerhetsanordninger aktiveres og varmepumpen slutte å fungere.



Maksimumstemperaturen for oppvarming er begrenset til 32°C for å unngå forringelse av foringene. Hayward fraskriver seg alt ansvar i tilfelle av en bruk utover 32°C.

2. SPESIFIKASJONER (fortsetter)

2.3 Dimensjoner

Modeller:

ENPI4M / ENPI6M

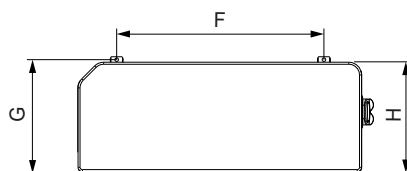
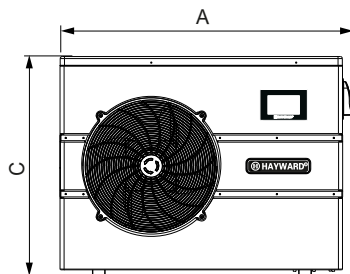
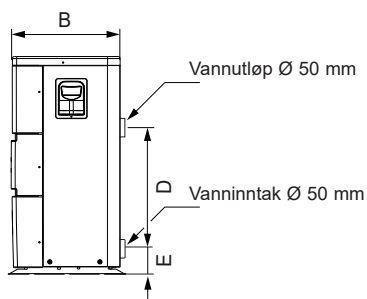

Enhet : mm

Nummer	Model	ENPI4M / ENPI6M
A		1046
B		400
C		768
D		350
E		110
F		615
G		428
H		400

3. INSTALLERING OG TILKOBLING

3.1 Skjematisk diagram

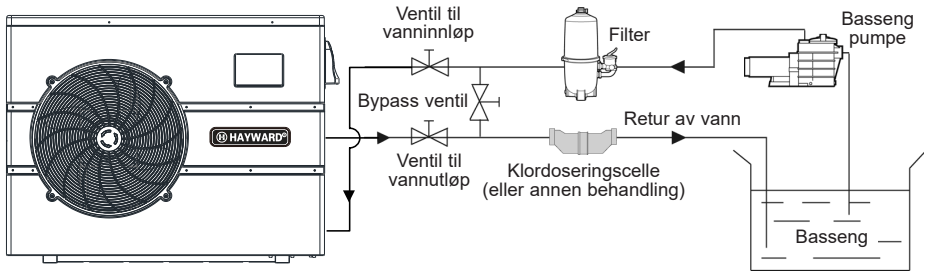

Merk: Varmepumpen er levert uten noe utstyr for behandling eller filtrering. Elementene som presenteres i diagrammer er deler som må leveres av installatøren.

3.2 Varmepumpe



Plasser varmpumpen utendørs, og ikke i lukkede tekniske lokaler.

Plassert under beskyttelse, må minsteavstander angitt nedenfor følges for å unngå resirkulering av luft, og en degradering av varmpumpens i totale prestasjoner.

Enhet: mm

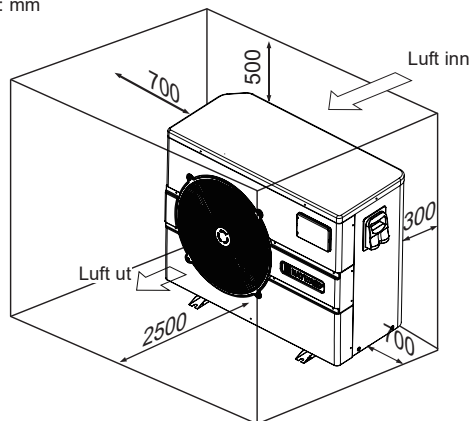

3. INSTALLERING OG TILKOBLING (fortsetter)



Helst installere varmpumpen på en frittliggende betongplate eller spesielt feste til dette formålet, og monter varmpumpen på de medfølgende Silentbloc-underlagene (skruer og skiver ikke inkludert).

Maksimal avstand for installasjon mellom varmpumpen og bassenget 15 meter.

Total tur-retur lengde for vannkanalene 30 meter.

Isoler vannkanaler på bakken og under jorden.

Varmepumpen må bygges opp og installeres med en minimum avstand fra bassenget, i henhold til standard NF C 15-100 (minst 3,5 meter fra bassenget i Frankrike) eller i henhold til gjeldende regler og forskrifter i hvert enkelt land.

Varmepumpen må ikke installeres i nærheten av en varmekilde.

I land hvor det er mye snø, bør det bygges opp et tak over maskinen for å unngå at snø bygger seg over ribbene på varmpumpen.

3.3 Vanntilkobling

Varmepumpen leveres med to koblingsdeler med diameter på 50 mm. Bruk PVC-rør på Ø 50 mm for vannkanaler. Koble varmpumpens vanninnløp til kanalen fra filteringsenheten, og koble deretter varmpumpens vannutløp til kanalen som går til bassenget (se diagram nedenfor).

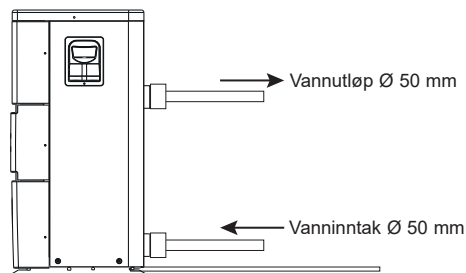

Installer en bypassventil mellom varmpumpens vanninnløp og vannutløp.



Dersom automatisk fordeler eller klordoseringscelle benyttes, må det være installert etter varmpumpen, for å beskytte Titanium-kondensatoren mot en for stor konsentrasjon av kjemiske stoffer.



Sørg for å installere bypassventilen og de medfølgende koblingsdelene ved enhetens vanninnløp og vannutløp, for å forenkle tømning om vinteren, for å forenkle tilgang eller demontering for vedlikehold.

3. INSTALLERING OG TILKOBLING (fortsetter)

3.4 Elektrisk tilkobling



Den elektriske installasjonen og kabling av dette utstyret må være i overensstemmelse med lokale forskrifter for installasjoner.

F	NF C15-100	GB	BS7671:1992
D	DIN VDE 0100-702	EW	EVHS-HD 384-7-702
A	ÖVE 8001-4-702	H	MSZ 2364-702/1994/MSZ 10-553 1/1990
E	UNE 20460-7-702 1993, RECBT ITC-BT-31 2002	M	MSA HD 384-7-702.S2
IRL	Wiring Rules + IS HD 384-7-702	PL	PN-IEC 60364-7-702:1999
I	CEI 64-8/7	CZ	CSN 33 2000 7-702
LUX	384-7.702 S2	SK	STN 33 2000-7-702
NL	NEN 1010-7-702	SLO	SIST HD 384-7-702.S2
P	RSIUEE	TR	TS IEC 60364-7-702



Kontroller at den tilgjengelige strømforsyningen og nettfrekvensen stemmer overens med operasjonelle krav, og tar hensyn til den spesifikke plasseringen til apparatet, og nødvendig strøm til å drive alle andre apparater som er koblet til samme krets.

ENPI4M 230V \sim +/- 10 % 50 Hz 1 Fase

ENPI6M 230V \sim +/- 10 % 50 Hz 1 Fase

Følg tilsvarende koblingsskjema i vedlegg.

Koblingsboksen ligger på enhetens høyre side. Tre tilkoblinger er til strømforsyning, og to til å styre filtreringspumpen (servomekanisme).

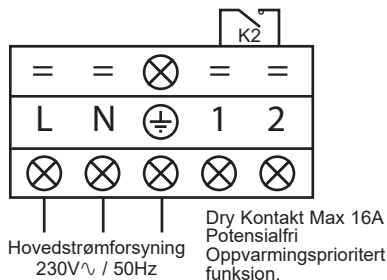

3. INSTALLERING OG TILKOBLING (fortsetter)



Strømledningen skal være utstyrt med en sikring av typen aM eller en effektbryter Kurve D, samt en 30mA jordfeilbryter (se tabell nedenfor).

Modeller		ENPI4M	ENPI6M
Elektrisk strømforsyning	V/Ph/Hz	230V~ 50Hz	230V~ 50Hz
Sikringsstørrelse av typen aM	A	8 aM	10 aM
Effektbryter Kurve D	A	8 D	10 D
Kabelseksjon	mm ²	3G 2,5	3G 2,5



Bruk en kabel av typen RO 2V / R 2V eller tilsvarende.





Kabelseksjonene er gitt for en lengde på maksimalt 25 meter. De må allikevel kontrolleres og tilpasses de gjeldene installasjonsforholdene.



Pass alltid på å stanse hovedstrømforsyningen før du åpner den elektriske kontrollboksen.

3.5 Førstegangs oppstart

Oppstartsprosedyre - når installasjonen er fullført bør du gjøre følgende:

- 1) Roter viften for hånd for å sikre at den kan rotere fritt for hånd, og at spiralen er riktig festet til motorakselen.
- 2) Se til at enheten er riktig tilkoblet til hovedstrømforsyningen (se koblingsskjema i vedlegg).
- 3) Slå på filtreringspumpen.
- 4) Se til at alle vannventiler er åpne og at vannet renner inn i enheten før varme eller avkjøling skrur på.
- 5) Sjekk at kondensutløpet er festet riktig og er fri for blokkeringer.
- 6) Aktiver enhetens strømforsyning og trykk på On/Off-knappen  på kontrollpanelet.
- 7) Sjekk at alarmsignalet ikke () lyser rødt. Hvis dette skjer, må du lese brukerveiledningen (se § 6.4).

3. INSTALLERING OG TILKOBLING (fortsetter)

- 8) Fastsett vannstrømmen ved hjelp av bypassventilen (se kapittel 3.6 og 2.1), som angitt for hver modell, slik at du oppnår en temperaturforskjell på 2 °C mellom vanninnløp og vannutløp.
- 9) Etter den har stått på noen minutter, sjekk at luften som kommer ut av enheten er kjøligere (mellom 5-10 °C).
- 10) Slå av filtreringspumpen mens enheten er i drift. Enheten skrur også av automatisk og viser feilkoden E03.
- 11) La enheten og filtreringspumpen stå på hele døgnet helt til ønsket vanntemperatur er nådd. Enheten slås av når gitt temperatur for vanninnløp er nådd. Enheten vil nå automatisk restarte (så lenge filtreringspumpen er på) når vanntemperaturen blir 2 °C mindre enn angitt temperatur.

Vannsirkulasjonsbryter - Enheten er utstyrt med en bryter som aktiverer varmepumpen når filtreringspumpen er på, og skrur den av når pumpen skrur av. Ved mangel på vann, vises alarmkoden E03 på kontrolleren (Se kapittel 6.4).

Tidsforsinkelse - enheten er utstyrt med en innebygd 3-minutters omstartsforsinkelse for å beskytte kontrollkretsens deler og for å fjerne omstartssyklus og støy. Denne tidsforsinkelsen vil automatisk omstarte enheten ca. 3 minutter etter hver avbrytelse av kontrollkretsen. Selv et kort strømavbrudd vil aktivere tidsforsinkelsen og forhindre enheten fra å starte før nedtellingen på 3 minutter er over.

3. INSTALLERING OG TILKOBLING (fortsetter)

3.6 Innstilling av vannstrømmen

Ventilene for vanninnløp og vannutløp er åpne, juster bypassventilen for å få en temperaturforskjell på 2 °C mellom vanninnløp og vannutløp (se skjematisk diagram kapittel 3.1). Du kan kontrollere innstillingen ved å se på temperaturene for innløp/utløp direkte på kontrollpanelet.

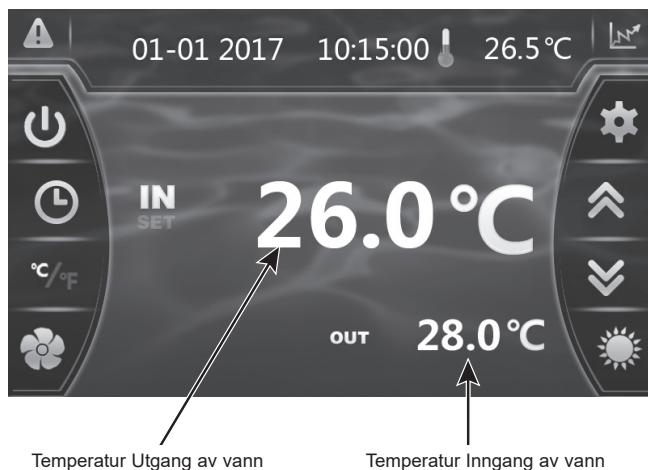

Merk: Åpningen av bypassventilen genererer en mindre viktig strømning eller økt ΔT .

Lukking av bypassventilen genererer en sterkere strømning, eller en nedgang i ΔT .

4. BRUKERGRENSESNITT

4.1 Oversikt

Varmepumpen er utstyrt med et digitalt kontrollpanel med berøringsskjerm, elektrisk tilkoblet og forhåndsinnstilt i fabrikk til varmedrift.



Tegnforklaring

1		Alarm (blinker rødt)
2		Låst skjerm
3		Dato
4		Klokkeslett
5		Utendørstemperatur
6		Lagringsbase (vanntemperatur og absorbert ytelse)
7		Parameter-innlesing og backup
8		Oppover / Øke
9		Nedover / Minske
10		Valg av driftsmodus
10a		Kjøle modus

10b		Oppvarmingsmodus
10c		Automatisk modus
11		Temperatur Inngang av vann
12		Valg av Silence-modus
12a		Innstilling av Timer i Silence-modus
12b		Indikator for Silence-modus og aktivering
13		Konvertering °C / °F
14		Temperatur Utgang av vann
15		Justering av dato og klokkeslett Timer ON/OFF
16		Opptining på gang
17		On/Off

4. BRUKERGRENSESNITT (fortsetter)

OFF-modus

Når varmpumpen er i standby (OFF-modus) knappen  er nedtonet.

ON-modus

Når varmpumpen er i drift eller under innstilling (ON-modus) knappen  lyser grønt.

4.2 Justering av dato og klokkeslett



Tilbake til forrige skjerm 

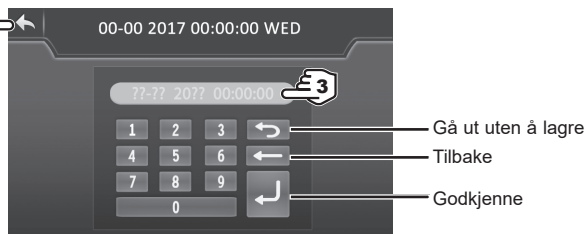

Registrer alle feltene (Dag/Måned/År, Timer/Minutter/Sekunder før du godkjenner, ellers vil endringene ikke lagres.

4.3 Innstilling av Timer

Du stiller inn på denne funksjonen hvis du ønsker å sette varmpumpen i drift i løpet av en kortere periode enn den som er fastsatt av filtreringstimeren. Slik kan du programmere en forsinket start og en tidligere stans, eller rett og slett forby en tidsinnstilling for drift (for eksempel om natten).

Du kan programmere 1 Start-timere og 1 Stopp-timere.

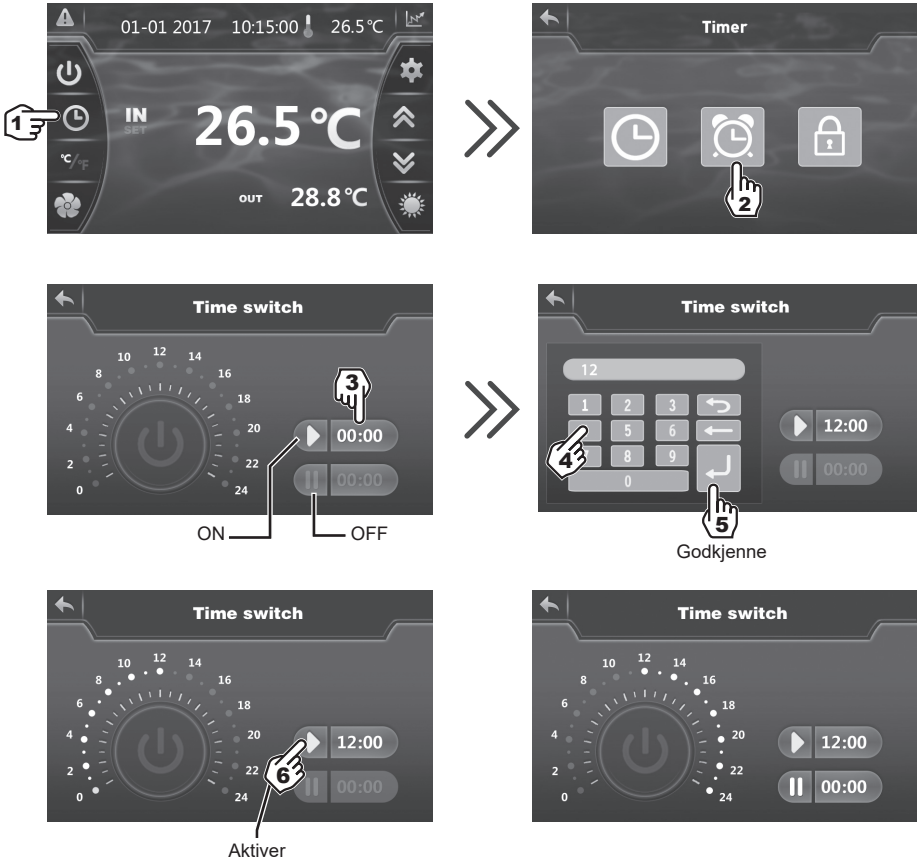

4. BRUKERGRENSESNITT (fortsetter)



Blå markering = Aktivert
Nedtonet = Deaktivert



Justeringstrinnet er fra "time til time".



- Etter at du har justert starttiden, trykk på  (trinn 6) for å aktivere Timeren. Symbolet og klokkeslettet markeres i blått.
- Gjenta trinn 3 til 6 for å stille inn og for å aktivere stansetiden ( 00:00).
- Når innstillingene er gjort, vil driftsperioden for varmepumpen vises med grønn markering, og perioden uten drift vil vises med gul markering.
- Trykk 2 ganger på  for å komme tilbake til hovedskjermen.

4. BRUKERGRENSESNITT (fortsetter)

4.4 Innstilling og visning av settpunkt



I modus "OFF" og Modus "ON"

Trykk på knappen  for å vise settpunktet, og trykk deretter på  eller for  å registrere et ønsket settpunkt.

Bekreft ved å trykke på , du kommer automatisk tilbake til hovedskjermen.



Innstillingen foretas med en nøyaktighet på 0,5 °C.



Det anbefales å ikke overstige en temperatur på 30 °C for å unngå forandring i basseng-liners.

4. BRUKERGRENSESNITT (fortsetter)

4.5 Låse og låse opp berøringsskjermen

Kontrolldisplayet låses automatisk etter ett minutt (standardinnstilling). Du kan justere tiden mellom 1 og 10 minutter før displayet låses automatisk. Du kan også avbryte denne funksjonen.



Automatisk låsing er aktivert

- 3) Juster tiden mellom 1 og 10 minutter. Lagringen gjøres automatisk.
- 4) Trykk 2 ganger på for å komme tilbake til hovedskjermen.
- 5) For å deaktivere automatisk låsing, trykk på .

For å låse opp displayet, trykk (hvor som helst) på displayet i 2 sekunder. Tast inn koden "22" og bekreft ved å trykke på



4. BRUKERGRENSESNITT (fortsetter)

4.6 Innstilling av funksjon SILENCE

I Silence-modus kan du bruke varmepumpen i økonomisk modus, på lavt lydnivå, dersom oppvarmingsbehovet ikke er sterkt (hvis vanntemperaturen kun skal holdes jevn, eller hvis du trenger å ha stillegående drift).

Denne funksjonen kan aktiveres/deaktiveres enten manuelt eller ved hjelp av en tidtaker.

Manuell aktivering

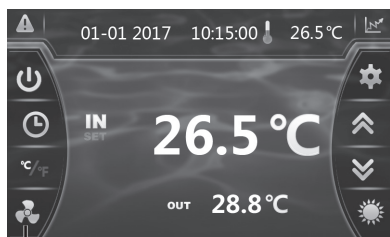

Silence-modus er aktivert

4. BRUKERGRENSESNITT (fortsetter)

Manuell deaktivering



Silence-modus er deaktivert

Innstilling av Timeren

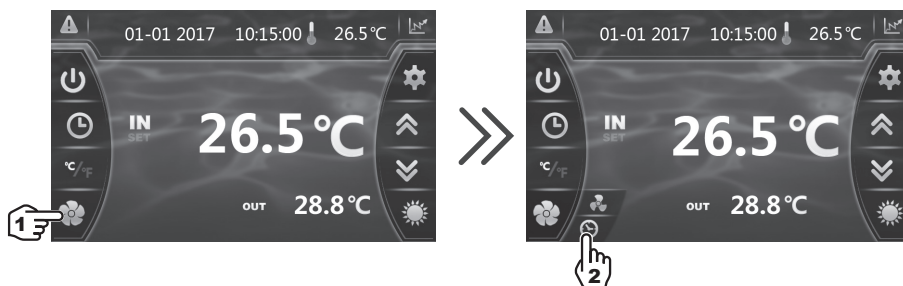

4. BRUKERGRENSESNITT (fortsetter)

Innstilling av Timeren (fortsetter)

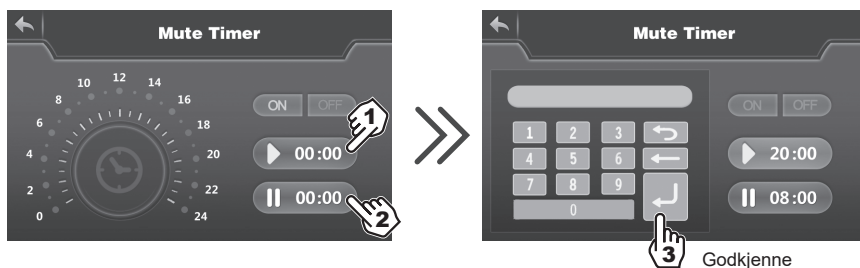

- 1) Starttid, registrering og godkjenning.
- 2) Stansetid, registrering og godkjenning.
- 3) Godkjenne.

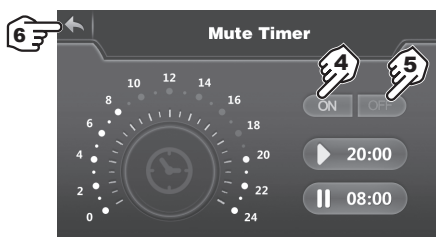

- 4) Aktivering.
- 5) Deaktivering.
- 6) Tilbake til hovedskjerm.



**Justeringstrinnet er fra "time til time".
Når Timeren er aktivert, er den aktiv hele uka.**

5. VEDLIKEHOLD OG VINTERKLARGJØRING

5.1 Vedlikehold

Disse vedlikeholdsoperasjonene må utføres en gang i året for å sikre lang levetid og god drift av varmpumpen.

- Rengjør fordampere med en myk børste eller med en luft- eller vannstråle (**NB! Bruk aldri høytrykksspyler**).
- Kontroller evakuering av kondensat.
- Kontroller at elektriske og hydrauliske koblinger sitter godt
- Kontroller vann tettheten til kondensatoren.
- La en kvalifisert fagmann sjekke tettheten på kjølekretsen ved hjelp av en lekkasje-detektor.



Før alt vedlikehold må varmpumpen være frakoblet alle strømkilder. Vedlikeholdsoperasjoner skal bare utføres av personell som er kvalifisert til å håndtere kuldemedier.

5.2 Vinterklargjøring

- Sett varmpumpen i "OFF"-modus.
- Slå av varmpumpens strømforsyning.
- Tøm kondensatoren ved hjelp av tømmeventilen for å unngå fare for degradering. (høy risiko for frost).
- Lukk bypassventilen og skru løs koblingsdelene til vanninnløp/vannutløp.
- Fjern maksimalt med stillestående vann som er igjen i kondensatoren ved hjelp av en blåsepistol.
- Forsegle varmpumpens vanninnløp og vannutløp for å hindre at fremmedlegemer kommer seg inn.
- Dekk til varmpumpen med vinterbelegget som er tiltenkt dette formålet.



Alle skader som er forårsaket av uriktig vinterklargjøring vil ugyldiggjøre garantien.

6. VEDLEGG

6.1 Koblingsskjemaer

ENPI4M

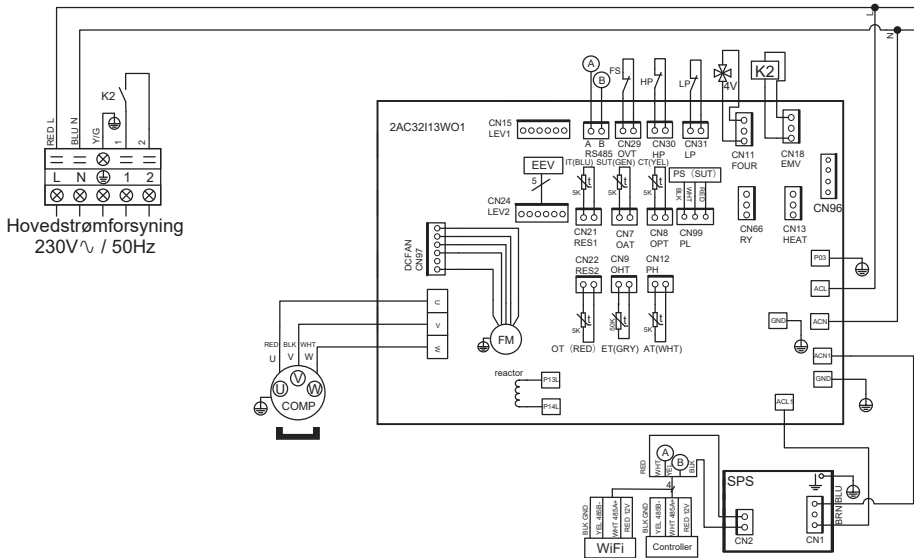

MERKNADER

- | | |
|---|---|
| AT : SENSOR FOR LUFTEMperatur | LP : LAVTRYKKSbRYTER |
| COMP : KOMPRESSOR | OT : TEMPERATURSENSOR TIL VANNUTLØP |
| CT : SENSOR FOR FORDAMPET TEMperatur | SUT : SENSOR FOR SUGETEMperatur |
| EEV : ELEKTRONISK EKSPANSJONSVENTIL | 4V : 4-VEIS VENTIL |
| FM : VIFTEMOTOR | K2 : POTENSIALFRI KONTAKT, MAKS. 16A |
| FS : VANNSENSOR | ET : TEMPERATURSENSOR FOR UTLADNING |
| HP : HØYTRYKKSbRYTER | PS : TRYKKSSENSOR |
| IT : TEMPERATURSENSOR TIL VANNINNLØP | |

6. VEDLEGG (fortsetter)

ENPI6M

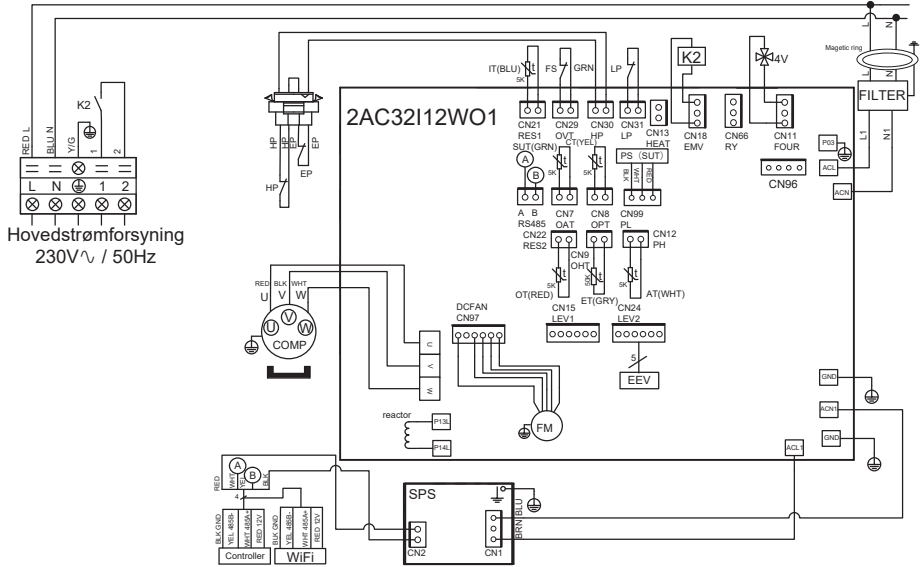

MERKNADER

- | | |
|---|---|
| AT : SENSOR FOR LUFTEMPERATUR | LP : LAVTRYKKSBRYSER |
| COMP : KOMPRESSOR | OT : TEMPERATURSENSOR TIL VANNUTLØP |
| CT : SENSOR FOR FORDAMPET TEMPERATUR | SUT : SENSOR FOR SUGETEMPERATUR |
| EEV : ELEKTRONISK EKSPANSJONSVENTIL | 4V : 4-VEIS VENTIL |
| FM : VIFTEMOTOR | K2 : POTENSIALFRI KONTAKT, MAKS. 16A |
| FS : VANNSENSOR | ET : TEMPERATURSENSOR FOR UTLADNING |
| HP : HØYTRYKKSBRYSER | PS : TRYKKSSENSOR |
| IT : TEMPERATURSENSOR TIL VANNINNLØP | |

6. VEDLEGG (fortsetter)

6.2 Kobling med prioritet på enfaset varmpumpe

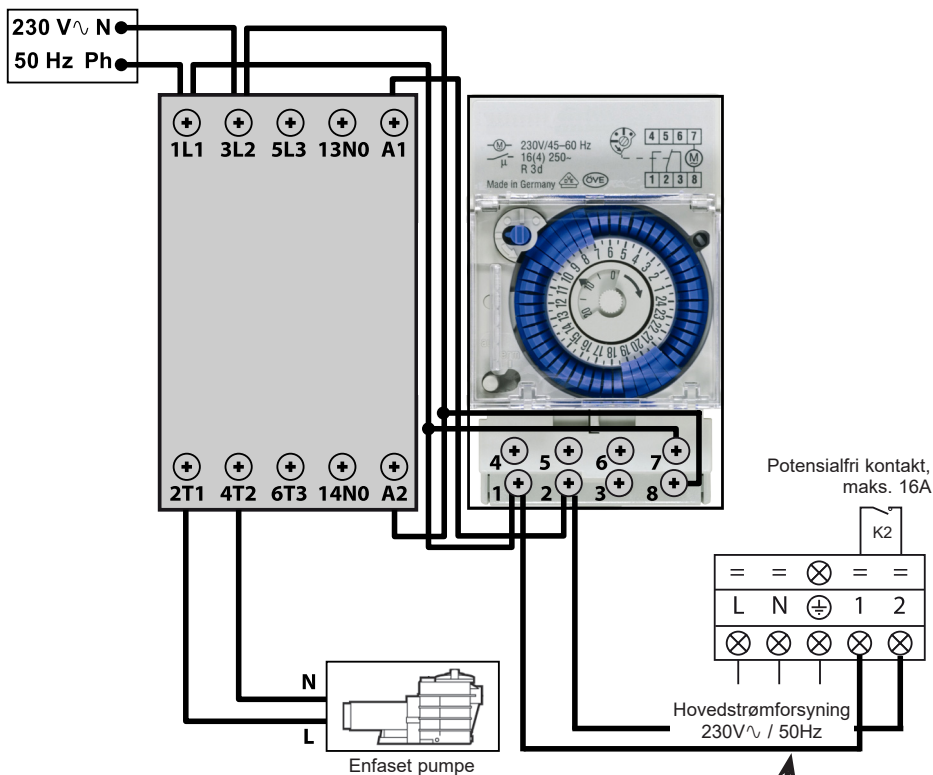

“Terminalene 1 og 2 gir et tørt kontaktpotensial uten polaritet 230 V \sim / 50 Hz.

Kabling til klemmene 1 og 2 i samsvar med ledningene beskrevet ovenfor, for å kontrollere driften av pumpen ved filtrering syklus 2 min hver time hvis temperaturen i tanken er under det innstilte punktet. “

 Aldri koble strømtilførselen til filterpumpen direkte på terminalene 1 og 2.



Denne siden er blank med hensikt

6. VEDLEGG (fortsetter)

6.3 Sprengskisse og reservedeler

ENPI4M / ENPI6M

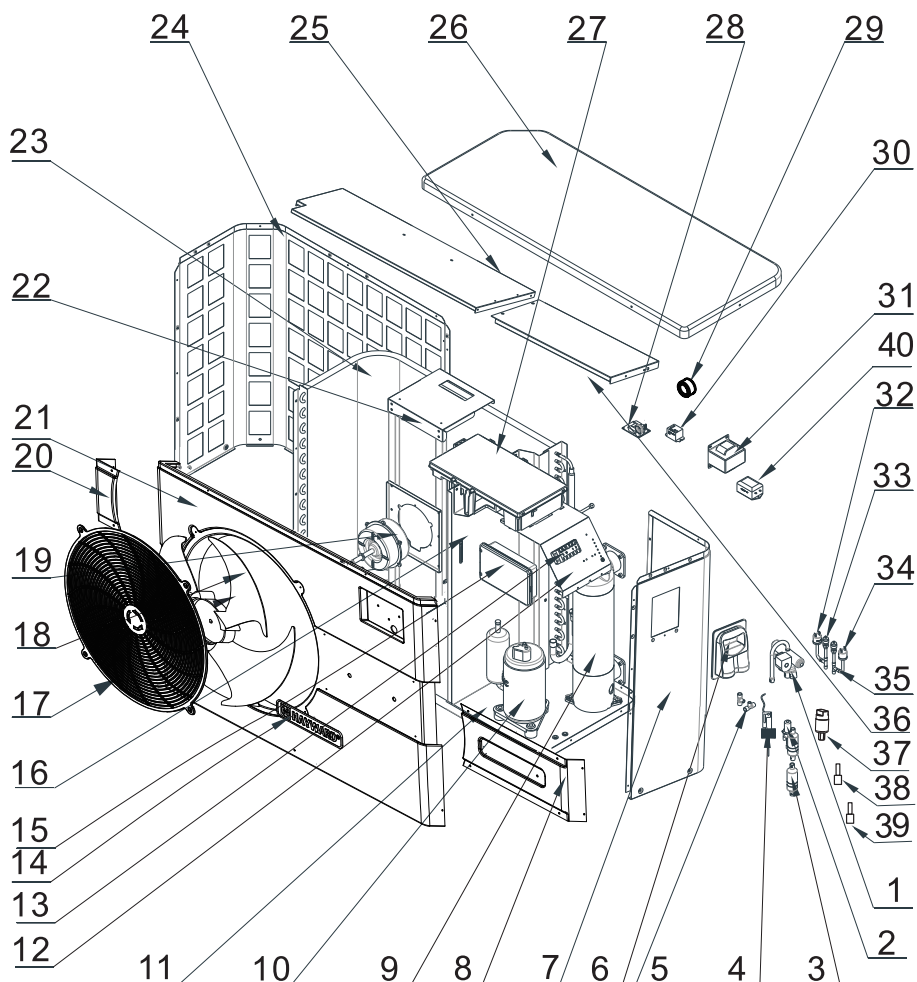

6. VEDLEGG (fortsetter)

ENPI4M / ENPI6M

Nr.	Betegnelse	Ref.	ENPI4M	ENPI6M
1	4-veisventil	HWX20041437	✓	✓
2	Elektronisk ekspansjonsventil	HWX81000015	✓	Gjelder ikke
		HWX81000016	Gjelder ikke	✓
3	Filter ø9.7-ø9.7 (Ø28)	HWX20041444	✓	✓
4	Sensor for vannstrømning	HWX83000012	✓	✓
5	T-format connector ø9.52-2 x ø6.5(T) x 1.0	HWX304030000002	✓	✓
6	Trappe elektrisk tilgang	HWX320922029	✓	✓
7	Høyre panel	HWX80700455	✓	✓
8	Høyre dekorpanel	HWX80900089	✓	✓
9	Kondensator Titanium/PVC	HWX80600074	✓	Gjelder ikke
		HWX80600096	Gjelder ikke	✓
10	Kompressor	HWX20000110448	✓	Gjelder ikke
		HWX80100003	Gjelder ikke	✓
11	/	/	/	/
12	/	/	/	/
13	Terminal L-N-GND -5 tilkøplinger 4mm ²	HWX40003901	✓	✓
14	HAYWARD-logo	HWX20000230596	✓	✓
15	Berøringskjerm med farger	HWX95005310612	✓	✓
16	/	/	/	/
17	Beskyttelsesgitter for viften	HWX20000220169	✓	✓
18	Vifteproprell	HWX20000270004	✓	✓
19	Viftemotor DC	HWX20000330132	✓	✓
20	Venstre dekorpanel	HWX80900088	✓	✓
21	Fremre panel	HWX80900087	✓	✓
22	Motorstøtte	HWX80700248	✓	✓
23	Vinget fordampner	HWX80600044	✓	Gjelder ikke
		HWX80600100	Gjelder ikke	✓
24	Venstre panel	HWX80700455	✓	✓
25	/	/	/	/
26	Øvre panel	HWX301090200806	✓	✓
27	Elektronisk Driver-kort	HWX82300008	✓	Gjelder ikke
		HWX82300007	Gjelder ikke	✓
28	Transformator 230V~/12VDC	HWX82600008	✓	✓
29	/	/	/	/
30	Relé K2	HWX20000360297	✓	✓
31	Spole 20A 50Hz 5mH	HWX82500005	✓	✓
32	Strømningsbegrenser NO 0.30MPa/0.15MPa	HWX20000360157	✓	✓
33	Trykktilkobling 40mm, 1/2"	HWX20000140150	✓	✓
34	Høytrykkspressostat NC 3.2MPa/4.4MPa	HWX20013605	✓	✓
35	T-format connector ø6.5-2 x ø6.5(T) x 0.75T2M	HWX20001460	✓	✓
36	/	/	/	/
37	Trykksensor	HWX20000360123	✓	✓
38	Kompressorutladningssonde 50 kΩ-660mm	HWX83000026	✓	✓
39	Lufttemperatur probe 5k-350mm	HWX83000049	✓	✓
	Vannuttak probe 5k-410mm	HWX83000050	✓	✓
	Vanninntak probe 5k-850mm	HWX83000052	✓	✓
	Kompressorsugesonde 5k-560mm	HWX83000044	✓	✓
	Avrimings sensor 5k-680mm	HWX83000051	✓	✓
40	EMC Filter	HWX20003257	Gjelder ikke	✓

6. VEDLEGG (fortsetter)

6.4 Veiledning for feilsøking



Enkelte operasjoner må utføres av en kvalifisert tekniker.

Hvis det oppstår en feil på varmpumpen, vil symbolet  blinke rødt i øvre venstre hjørne på displayet.

Trykk på symbolet  for å få opp listen med feilene.

Se tabellen lenger ned.

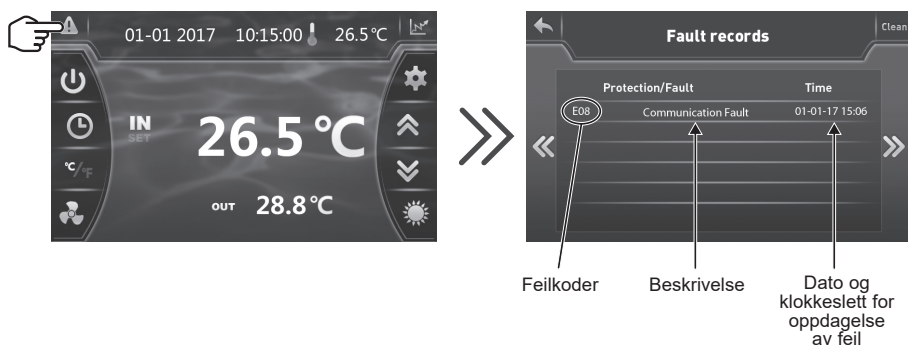

Etter at feilen er opphevet, vil den fjernes automatisk fra listen, og trekanten vil vises i fast grå farge.



*For å slette feillisten, trykk på **Clean** og gå tilbake til forrige skjerm ved å trykke på .*

6. VEDLEGG (fortsetter)

Feil	Feilkoder	Beskrivelse	Løsning
Feil i temperatursensor til vanninnløp	P01	Sensoren er åpen eller det er en kortslutning.	Sjekk kopplingsforbindelsen CN21/RES1 på kortet og konnektoren eller skift ut sensoren
Feil i temperatursensor til vannutløp	P02		Sjekk kopplingsforbindelsen N22/RES2 på kortet og konnektoren eller skift ut sensoren
Feil på avrimingssensor	P04		Sjekk kopplingsforbindelsen CN12/PH på kortet og konnektoren eller skift ut sensoren
Feil på sensor til utendørstemperatur	P05		Sjekk kopplingsforbindelsen CN8/OPT på kortet og konnektoren eller skift ut sensoren
Feil på kompressor aspirasjonssensor	P07		Sjekk kopplingsforbindelsen CN7/OAT på kortet og konnektoren eller skift ut sensoren
Feil på kompressorutladningsføler	P081		Sjekk kopplingsforbindelsen CN9/OHT på kortet og konnektoren eller skift ut sensoren
Høytrykksbeskyttelse	E01	Sensoren er åpen eller det er en kortslutning.	<p>Sjekk CN30/HP koblingen på kortet eller bytt sensor</p> <p>Sjekk vannmengden</p> <p>Sjekk detektoren for vannmengde</p> <p>Sjekk at ventilene er åpne</p> <p>Sjekk by-passventilen</p> <p>Sjekk at fordampere ikke er tett</p> <p>Vanntemperaturen er for høy</p> <p>Kondensproblemer etter vedlikeholdsarbeid, tøm hele kjølekretsen</p> <p>For stor væskemengde, tøm noe væske ut i en flaske</p>
Lavtrykksbeskyttelse	E02	Sensoren er åpen eller det er en kortslutning.	<p>Sjekk AI/DI03 koblingen på kortet eller bytt sensor</p> <p>Stor lekkasje med kjølevæske, foreta en lekkasjetest med detektor</p> <p>Luftmengden er for lav, sjekk hastigheten til vifterotasjonen</p> <p>Sjekk at fordampere ikke er tett, rengjør den på overflaten</p>
Feil i sensor for vannstrømning	E03	Sensoren er åpen eller det er en kortslutning.	<p>Sjekk AI/DI02 koblingen på kortet eller bytt sensor</p> <p>Ikke nok vann, sjekk filtreringspumpens drift</p> <p>Sjekk at vannkranene er åpne</p> <p>Sjekk justeringen av by-passventilen</p>

6. VEDLEGG (fortsetter)

Feil	Feilkoder	Beskrivelse	Løsning
Temperaturforskjellen mellom Innløp og Utløp >13°C	E06	Gjelder kun Kald-Modus	Ikke nok vann, sjekk filtreringspumpens drift
			Sjekk at vannkranene er åpne
			Sjekk justeringen av by-passventilen
Tinesyklus Kjølemodus	E07	Temperatur av utgående vann < 4°C	Stans varmpumpen, tøm kondensatoren, fare for frost
Kommunikasjonsfeil	E08	Ingen kommunikasjon mellom det elektroniske kortet og brukergrensesnittet	Sjekk kablingene og kopplingsforbindelsene – se elektrisk diagram
Første nivå av frostbeskyttelse om vinteren	E19	2° < Vanntemperaturen < 4° og Lufttemperaturen < 0°	Stans varmpumpen, tøm kondensatoren, for å unngå frost. Som standard vil varmpumpen starte filtreringspumpen og varmpumpen for at ikke vannet skal fryse.
Andre nivå av frostbeskyttelse om vinteren	E29	Vanntemperaturen < 2° og Lufttemperaturen < 0°	Stans varmpumpen, tøm kondensatoren, for å unngå frost. Som standard vil varmpumpen starte filtreringspumpen og varmpumpen for at ikke vannet skal fryse.
Feil i viftemotor	F031	Motoren er blokkert eller forbindelsesfeil	Sjekk at det er fri rotasjon; sjekk kopplingsforbindelsene CN97/DCFan; skift ut motoren
Feil i viftemotor	F051	Forbindelsesfeil	Sjekk kopplingsforbindelsen DCFAN/CN97; skift ut motoren
For lav utendørs temperatur	TP	Driftgrensen er nådd	Slå av varmpumpen
Feil med trykksensoren	PP	Sensoren er åpen eller det er en kortslutning	Sjekk strømkoblingene (se koblingskjemaet)

6. VEDLEGG (fortsetter)

6.5 Lagringsbase

Ut i fra hovedskjermen, trykk på  for å se loggen med lagrede verdier for inngående og utgående vann.



Disse verdiene er tilgjengelig i 60 dager.

Trykk på  for å lese gjennomsnittlig strømforbruk.

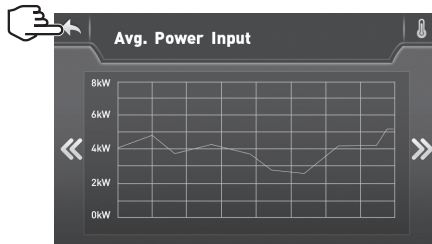
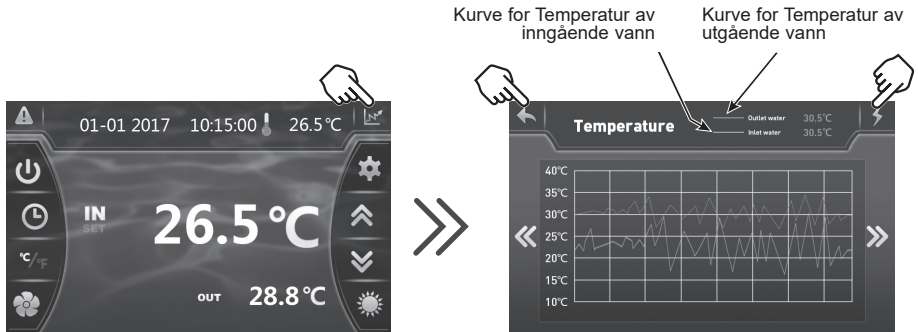

Trykk på  for å komme tilbake til hovedskjermen.

6. VEDLEGG (fortsetter)

6.6 Garanti

GARANTIBETINGELSER

HAYWARD garanterer at deres produkter er fri for defekter i materiale og i utførelse for en periode på to år fra innkjøpsdato. Ved evt. garantikrav, må kvittering for kjøpet fremlegges. Vi ber om at kvitteringen blir tatt vare på av kjøper.

HAYWARD garanti er, etter HAYWARD eget valg, begrenset til erstatning eller reparasjon av defekte produkter som har vært i normal bruk og behandlet i henhold til instruksjonsboken, uten at det har vært foretatt endringer av produktet, og at bare ekte HAYWARD deler har vært brukt. Skader som skyldes frost og kjemiske reaksjoner er ikke omfattet av denne garanti.

HAYWARD er ikke ansvarlig for noen andre kostnader (flytting, arbeidskostnader osv...), heller ikke for direkte eller indirekte skader som skyldes funksjonsfeil ved et produkt.

For å sette i gang et garantikrav og å be om reparasjon eller erstatning av et produkt, vennligst ta kontakt med forhandleren. Forsendelse av produkter direkte til vår fabrikk blir ikke akseptert uten vår skriftlige forhåndsgodkjenning.

Slitasjedeler omfattes ikke av garantien.

ISENPINVR32

ENERGYLINE PRO iNVERTER

ТЕПЛОВОЙ НАСОС ДЛЯ ПЛАВАТЕЛЬНОГО БАССЕЙНА



Руководство по монтажу и эксплуатации

СОДЕРЖАНИЕ

1. ПРЕДИСЛОВИЕ	1
2. ТЕХНИЧЕСКИЕ ХАРАКТЕРИСТИКИ	4
2.1 Технические данные теплового насоса	4
2.2 Рабочий диапазон	5
2.3 Размеры	6
3. УСТАНОВКА И ПОДКЛЮЧЕНИЕ	7
3.1 Принципиальная Схема	7
3.2 Тепловой насос	7
3.3 Гидротехническое подключение	8
3.4 Электрическое Подключение	9
3.5 Первый запуск	10
3.6 Установка пропускной способности насоса	12
4. ИНТЕРФЕЙС ПОЛЬЗОВАТЕЛЯ	13
4.1 Общие сведения	13
4.2 Настройка даты и времени	14
4.3 Настройка функции Таймер	14
4.4 Установка и визуализация заданного значения	16
4.5 Блокировка и разблокировка тактильного экрана	17
4.6 Настройка функции бесшумного режима SILENCE	18
5. ТЕХНИЧЕСКОЕ ОБСЛУЖИВАНИЕ И КОНСЕРВАЦИЯ НА ЗИМУ	21
5.1 Техническое обслуживание	21
5.2 Консервация на зиму	21
6. ПРИЛОЖЕНИЯ	22
6.1 Электрические схемы	22
6.2 Включение подогрева в качестве приоритета	24
6.3 Вид в разборе и съемные элементы	26
6.4 Справочник по устранению неисправностей	28
6.5 Регистрация данных	31
6.6 Гарантия	32

Внимательно прочитать и сохранить для дальнейших консультаций.

Этот документ необходимо передать владельцу плавательного бассейна, чтобы он его сохранил в надежном месте.

1. ПРЕДИСЛОВИЕ

Благодарим вас за покупку теплового насоса для бассейна Hayward. Тепловой насос Hayward FULL INVERTER был разработан согласно строгим производственным стандартам, чтобы соответствовать высочайшему уровню требуемого качества.

Тепловые насосы Hayward обеспечат невероятную производительность на протяжении всего купального сезона, регулируя мощность, энергопотребление и уровень шума, необходимые для подогрева бассейна, с помощью логической схемы контроля FULL INVERTER.



Перед использованием устройства внимательно прочитайте инструкции, приведенные в этом руководстве.

Тепловые насосы Hayward предназначены исключительно для нагрева воды в бассейне. Не используйте это оборудование для других целей.

Это руководство включает в себя всю необходимую информацию, касающуюся установки, устранения неполадок и технического обслуживания.

Внимательно прочитайте это руководство, прежде чем открывать устройство или выполнять техническое обслуживание. Производитель данного продукта не будет нести ответственность в случае получения пользователем травмы или повреждения устройства из-за возможных ошибок во время установки, устранения неисправностей или неправильного технического обслуживания. Крайне важно всегда следовать инструкциям этого руководства.

Любое невыполнение рекомендаций аннулирует гарантию.

1. ПРЕДИСЛОВИЕ (продолжение)



Правила техники безопасности



Это устройство содержит R32.

Используйте исключительно хладагент R32. Любое другое газообразное вещество, смешанное с R32, может спровоцировать чрезмерное давление, которое может привести к поломке или разрыву труб и травмированию людей.

Во время ремонта или технического обслуживания ни в коем случае не используйте медные трубы толщиной менее 0,8 мм.

Когда тепловой насос находится под давлением, не проделывайте отверстия в трубах и не пытайтесь их паять. Существует опасность взрыва.

Не подвергайте устройство воздействию огня, искр или других источников возгорания. Оно может взорваться, что, возможно, приведет к серьезным травмам или смерти.

- Тепловой насос должен храниться в хорошо проветриваемом помещении с площадью пола более $A_{\text{мин}}$ (м^2), определяемой по следующей формуле:
$$A_{\text{мин}} = (M / (2,5 \times 0,22759 \times h_0))^2,$$
где M — количество хладагента в устройстве в кг, а h_0 — высота хранения. Для напольного хранения $h_0 = 0,6$ м.
- Тепловой насос предназначен исключительно для установки на улице.
- Устанавливать устройство должен квалифицированный персонал.
- Не устанавливайте тепловой насос на подставку, которая может усилить вибрацию устройства.
- Убедитесь в том, что размер подставки для устройства соответствует его весу.
- Не устанавливайте тепловой насос в месте, которое может повышать уровень шума, или где шум от устройства может помешать соседям.
- Любые электрические соединения должны выполняться квалифицированным электриком-профессионалом и в соответствии с действующими в стране установки стандартами, см. § 3.4.
- Отключите основное электропитание и рубильник перед выполнением любых электрических работ. Невыполнение инструкций может привести к поражению электрическим током.

1. ПРЕДИСЛОВИЕ (продолжение)

- Перед установкой убедитесь в том, что заземляющий кабель не обрезан и не отсоединен.
- Подсоедините и правильно пережмите кабель питания. В случае плохого соединения электрические элементы могут повредиться.
- Воздействие воды или влажной среды на тепловой насос может привести к поражению электрическим током. Будьте очень осторожны.
- Если вы обнаружите какую-либо неисправность или аномальную ситуацию, не устанавливайте тепловой насос и немедленно свяжитесь с вашим дилером.
- Техническое обслуживание и различные операции должны выполняться с частотой и во время, рекомендуемые в этом руководстве.
- Ремонт должен выполняться квалифицированным персоналом.
- Используйте только оригинальные запчасти.
- Применяйте только рекомендованный в этом руководстве метод очистки.

Важная информация об используемом хладагенте

Этот продукт содержит фторированные парниковые газы, контролируемые Киотским протоколом. Не выпускайте эти газы в атмосферу.

Тип хладагента: R32

Значение ППП(1) — 675, значение основано на 4-м отчете МГЭИК.

Количество хладагента в соответствии с регламентом F-Gas 517/2014 указано на заводской табличке устройства.

В соответствии с европейским или местным законодательством могут потребоваться периодические проверки утечки хладагента. Для получения дополнительной информации свяжитесь с вашим местным поставщиком.

(1) Потенциал глобального потепления.

2. ТЕХНИЧЕСКИЕ ХАРАКТЕРИСТИКИ

2.1 Технические данные теплового насоса

Модели	ENERGYLINE PRO INVERTER	ENPI4M	ENPI6M
Напряжение питания	В	220V-240V ~ / 1ph / 50Hz	
Хладагент	/	R32	
Количество	кг	0,50	0,65
Масса в tCO ₂ eq	/	0,34	0,44
Частота проверок на наличие утечек	/	Требования отсутствуют, но рекомендуется ежегодно	
Нагревательная способность мин. – макс. ^(а)	кВт	2,50–9,73	3,20–11,9
Поглощаемая электрическая мощность мин. – макс. ^(а)	кВт	0,20–1,34	0,28–1,68
Номинальный эксплуатационный ток мин. – макс. ^(а)	А	1,33–6,02	1,34–7,32
КПД мин. – макс. ^(а)	/	12,32–7,12	11,51–7,10
Нагревательная способность мин. – макс. ^(б)	кВт	1,71–7,60	2,70–9,70
Поглощаемая электрическая мощность мин. – макс. ^(б)	кВт	0,27–1,49	0,44–1,88
КПД мин. – макс. ^(б)	/	6,40–5,1	6,10–5,55
Максимальный эксплуатационный ток (МЭТ)	А	7,30	8,90
Номинал плавкого предохранителя	аМ	8	10
Изогнутый предохранитель D	D	8	10
Пусковой ток	А	< МЭТ	< МЭТ
Гидравлическое соединение	мм	50mm	
Номинальный расход воды ^(а)	м ³ /ч	4,20	5,10
Максимальная потеря напора воды	кПа	3,3	4,5
Компрессор	/	DC Inverter Mitsubishi	DC Inverter Highly
Тип	/	Двойной ротационный	Двойной ротационный
Количество	/	1	
Сопротивление обмотки при температуре 20 °С	Ом	1,91	0,788
Вентилятор	/	осевой	
Количество		1	
Диаметр	мм	405	510
Количество лопастей	/	3	
Двигатель	/	DC Inverter	
Количество	/	1	1
Скорость вращения	об/мин	500–700	500-650
Скорость в бесшумном режиме	об/мин	300	400
Уровень акустического давления на 1 м	дБ(А)	33–41	33-41
Уровень акустического давления на 10 м	дБ(А)	16–25	16–25
Чистые размеры устройства (Д-Ш-В)	мм	1046/400/768	
Масса	кг	53	65

(а) Сухой воздух 27 °С — относительная влажность 78 % — температура воды на входе 26 °С.



(б) Сухой воздух 15 °С — относительная влажность 71 % — температура воды на входе 26 °С.

2. ТЕХНИЧЕСКИЕ ХАРАКТЕРИСТИКИ

(продолжение)

2.2 Рабочий диапазон

Для обеспечения надежной и эффективной работы теплового насоса используйте его в следующих рабочих диапазонах температур и влажности.

	Режим подогрева 	Режим Охлаждение 
Температура окружающей среды	-12°C – +35°C	+7°C – +43°C
Температура воды	+12°C – +40°C	+8°C – +40°C
Относительная влажность	< 80%	< 80%
Рабочий диапазон заданного значения	+15°C – +32°C	+8°C – +32°C



Если температура или влажность не соответствуют указанным условиям, может сработать защитное устройство, и тогда тепловой насос может отключиться.



Максимальная температура нагрева ограничена до 32°C во избежание повреждения покрытия. Фирма Nauward не несет ответственности в случае эксплуатации при температуре выше 32°C.

2. ТЕХНИЧЕСКИЕ ХАРАКТЕРИСТИКИ (продолжение)

2.3 Размеры

Модели :
ENPI4M / ENPI6M

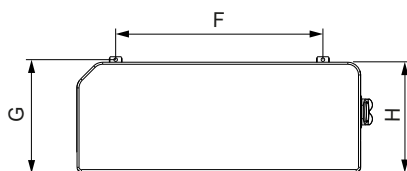
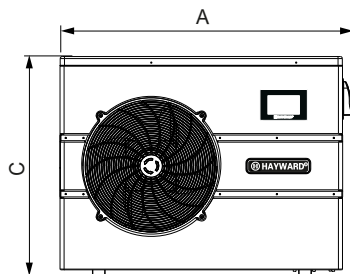
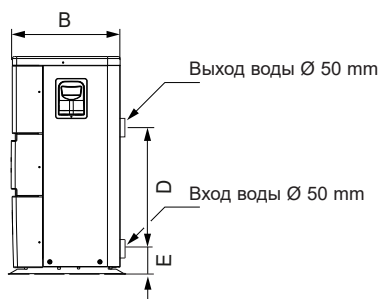

Устройство : mm

Позиция \ Модель	ENPI4M / ENPI6M
A	1046
B	400
C	768
D	350
E	110
F	615
G	428
H	400

3. УСТАНОВКА И ПОДКЛЮЧЕНИЕ

3.1 Принципиальная Схема

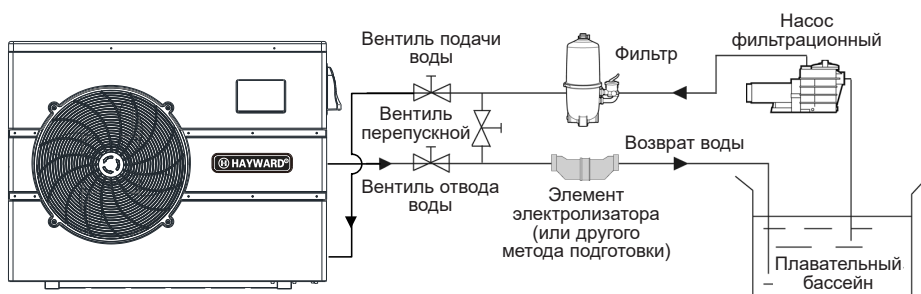

Примечание : Тепловой насос поставляется без какого-либо дополнительного оборудования для подготовки или фильтрации воды. Представленные на схеме элементы поставляются фирмой, осуществляющей установку.

3.2 Тепловой насос



Разместите тепловой насос на открытом воздухе, отдельно от любого другого закрытого оборудования.

Разместите его под навесом, с соблюдением всех указанных минимальных расстояний до других предметов, чтобы избежать всех рисков, связанных с рециркуляцией воздуха и возможным отрицательного влияния теплового насоса на состояние окружающей среды.

Устройство : мм

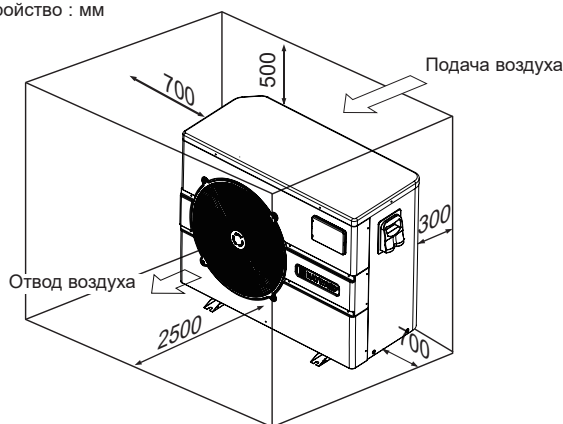

3. УСТАНОВКА И ПОДКЛЮЧЕНИЕ (продолжение)



Желательно установить тепловой насос на отдельной бетонной площадке или в другом предусмотренном для этого месте, с использованием входящих в комплект поставки сайлентблоков (болты и шайбы в комплект поставки не входят).

Максимальное расстояние между тепловым насосом и плавательным бассейном не должно превышать 15 м. Общая длина шлангов подачи и отвода воды не должна превышать 30 м.

Изолировать шланги от поверхности земли и не закапывать.

Тепловой насос должен быть установлен на минимальном расстоянии от бассейна в соответствии с NF C 15-100 (либо в 3,5 м от водной поверхности во Франции) или в соответствии со стандартами установки в других странах.

Не устанавливать тепловой насос вблизи источников тепла.

При установке в снежных регионах, рекомендуется устанавливать изделие в помещении, чтобы избежать накопления снега на испарителе.

3.3 Гидротехническое подключение

Тепловой насос поставляется с двумя штуцерными соединениями диаметром 50 мм с накидной гайкой. Для подвода воды используйте ПВХ шланги Ø 50 мм. Соедините входное отверстие для воды теплового насоса со шлангом, ведущим к фильтрационному блоку, затем соедините выходное отверстие для воды теплового насоса со шлангом, подающим воду в бассейн (см. приведенную ниже схему).

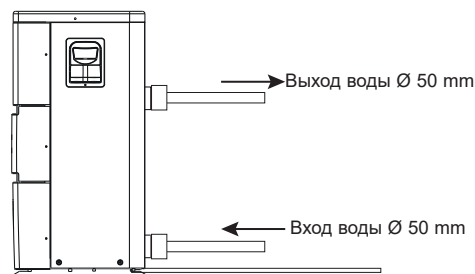

Установите так называемый "перепускной" вентиль между входным и выходным отверстиями теплового насоса.



Если используются автоматическое питательное устройство или электризатор, они должны быть установлены непосредственно после теплового насоса с целью предохранения конденсатора Titape от чрезмерного накопления в нем химических продуктов.



Постарайтесь установить перепускной вентиль и поставляемые штуцерные соединения на одном уровне с входом и выходом воды на устройстве, чтобы упростить спуск воды на зимний период, облегчив таким образом доступ к элементам и демонтаж на период технического обслуживания.

3. УСТАНОВКА И ПОДКЛЮЧЕНИЕ (продолжение)

3.4 Электрическое Подключение



Электроподключение и все соединения данного оборудования должны соответствовать местным действующим правилам установки.

Франция	NF C15-100	Великобритания	BS7671:1992
Дания	DIN VDE 0100-702	Англия и Уэльс	EVHS-HD 384-7-702
А	ÖVE 8001-4-702	Венгрия	MSZ 2364-702/1994/MSZ 10-553 1/1990
Испания	UNE 20460-7-702 1993, RECBT ITC-BT-31 2002	Мэн	MSA HD 384-7-702.S2
Ирландия	Монтажные правила + IS HD 384-7-702	Польша	PN-IEC 60364-7-702:1999
Италия	CEI 64-8/7	Чехия	CSN 33 2000 7-702
Люксембург	384-7.702 S2	Словакия	STN 33 2000-7-702
Нидерланды	NEN 1010-7-702	Словения	SIST HD 384-7-702.S2
Португалия	RSIUÉE	Турция	TS IEC 60364-7-702



Убедитесь, что имеющееся в наличии электропитание и частота соответствуют требуемым параметрам тока, приняв во внимание специфическую установку прибора и потребности всех других устройств, подключенных к данной цепи.

ENPI4M 230V ~ +/- 10 % 50 Hz 1 Фаза

ENPI6M 230V ~ +/- 10 % 50 Hz 1 Фаза

Соблюдайте требования соответствующей схемы соединений в приложении.

Соединительная коробка находится с правой стороны устройства. Три контактных соединения предназначены для подключения электропитания, два других - для подключения механизма управления фильтрационного насоса (Системы автоматического управления).

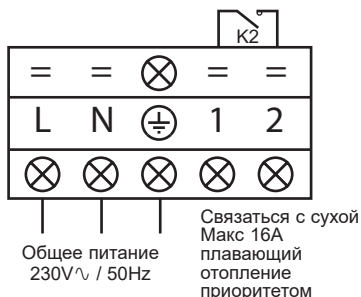

3. УСТАНОВКА И ПОДКЛЮЧЕНИЕ (продолжение)



Цепь электропитания должна быть снабжена соответствующим защитным устройством (предохранителем для защиты электродвигателей и кабелей типа aM) или автоматическим выключателем (кривая D), а также дифференциальным автоматом на 30 мА (см. следующую таблицу).

Модели		ENPI4M	ENPI6M
Электропитание	В/Фаза/Гц	230V~ 50Hz	230V~ 50Hz
Предел срабатывания предохранителя (*)	A	8 aM	10 aM
Автоматический выключатель, кривая D	A	8 D	10 D
Сечение кабеля	MM ²	3G 2,5	3G 2,5



Используйте кабель питания типа RO 2V / R 2V или аналогичный.



Сечения кабеля даны из расчета максимальной длины - 25 м. Тем не менее, необходимо их проверять и адаптировать согласно условиям установки.



Перед открытием блока электроуправления всегда отключайте источник основного питания.

3.5 Первый запуск

Процедура запуска - после того, как закончена установка, неуклонно следуйте следующему порядку действий :

- 1) Проверните вентиляторы рукой для проверки их свободного вращения и соответствия крепления винта на валу мотора.
- 2) Убедитесь в том, что устройство правильно подключено к источнику основного питания (см. схему соединения в приложении).
- 3) Включите фильтрационный насос.
- 4) Перед тем как перейти к режимам подогрева или охлаждения, проверьте, чтобы все вентили были открыты и чтобы вода поступала в устройство.
- 5) Проверьте, чтобы трубка оттока конденсата была правильно установлена, чтобы не создавалось никаких помех.
- 6) Включите электропитание устройства, затем нажмите кнопку Пуск/Стоп  на панели управления.

3. УСТАНОВКА И ПОДКЛЮЧЕНИЕ (продолжение)

- 7) Убедитесь, что не горит красный сигнал (⚠) тревоги. В соответствующих случаях, смотреть руководство по ремонту (см. § 6.4).
- 8) Установите пропускную способность для воды с помощью перепускного вентиля (см. § 3.6 и 2.1) на уровне, предусмотренном для соответствующей модели, так, чтобы разница температур воды на входе/выходе составляла 2°C.
- 9) После нескольких минут работы проверьте, чтобы температура воздуха, выходящего из устройства, понизилась (была между 5 и 10°).
- 10) Не выключая устройства, остановите фильтрационный насос. Устройство должно автоматически отключиться и показать код ошибки E03.
- 11) Оставьте устройство и насос плавательного бассейна включенными круглосуточно, пока температура воды не достигнет желаемого уровня. Когда температура воды на входе достигнет заданного значения, устройство отключится. Оно снова самостоятельно включится (при условии, что будет включен насос плавательного бассейна), если температура в плавательном бассейне понизится хотя бы на 0.5°C от заданной.

Контроллер пропускной способности - Устройство снабжено контроллером пропускной способности, который включает тепловой насос при включенном фильтрационном насосе плавательного бассейна, и отключает тепловой насос при неработающем фильтрационном насосе. При отсутствии поступления воды на экране регулятора загорится код ошибки E03 (См. § 6.4).

Задержка - устройство работает с задержкой в 3 минуты с целью защиты компонентов управляющей цепи, устранения любой нестабильности при повторном запуске и всех помех в цепи контактора. Благодаря данной задержке устройство автоматически включается примерно через 3 минуты после полного отключения управляющей цепи. Таким же образом кратковременное отключение тока активизирует цепь задержки включения.

3. УСТАНОВКА И ПОДКЛЮЧЕНИЕ (продолжение)

3.6 Установка пропускной способности насоса

Открыв вентили входа и выхода воды, отрегулируйте так называемый "перепускной" вентиль так, чтобы разница между температурами воды на входе и выходе составляла 2°C (см. § 3.1 принципиальной схемы). Вы можете проверить правильность регулировки, контролируя отображаемые на командной панели значения температур воды на входе и выходе.



Температура воды на входе

Температура воды на выходе

Примечание : Открытие так называемого "перепускного" вентиля понижает влияние пропускной способности на повышение разницы температур ΔT .
Закрытие так называемого "перепускного" вентиля повышает влияние пропускной способности на понижение разницы температур ΔT .

4. ИНТЕРФЕЙС ПОЛЬЗОВАТЕЛЯ

4.1 Общие сведения

Тепловой насос оборудован панелью цифрового управления с тактильным экраном, соединенной электрически с устройством и настроенным на заводе на режим подогрева.



Условные обозначения

1		Тревога (красный мигающий сигнал)
2		Экран заблокирован
3		дата
4		время
5		Температура окружающей среды
6		Регистрация данных (температура воды и потребляемая мощность)
7		Чтение настроек и сохранение
8		Перемещение вверх/Увеличение
9		Перемещение вниз/Уменьшение
10		Выбор режима работы
10a		Режим Охлаждения

10b		Режим Подогрева
10c		Режим Автоматический
11		Температура воды на выходе
12		Выбор режима тишины
12a		Настройка таймера режима тишины
12b		Индикатор режима тишины и активации
13		Конвертация °C/°F
14		Воды на входе
15		Настройка даты и времени; Таймер ON/OFF
16		Режим оттаивания
17		Пуск/Стоп

4. ИНТЕРФЕЙС ПОЛЬЗОВАТЕЛЯ (продолжение)

Режим ВЫКЛ.

Когда тепловой насос находится в спящем режиме (Режим ВЫКЛ), кнопка  серого цвета .

Режим ВКЛ.

Когда тепловой насос находится в рабочем или регулировочном режиме (Режим ВКЛ), кнопка  становится зеленой.

4.2 Настройка даты и времени



Возврат к предыдущему экрану 

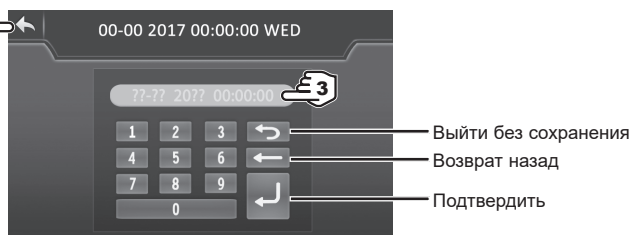

Заполните все поля (день/месяц/год, час/минута/секунда) перед подтверждением, в противном случае изменения не будут сохранены.

4.3 Настройка функции Таймер

Установка этой функции нужна в том случае, если Вы хотите, чтобы тепловой насос работал в течение более короткого периода времени по сравнению с установленным временем фильтрации. Вы также можете запрограммировать произвольное время включения и выключения или просто отключить временной рабочий диапазон (например, ночью). Вы можете запрограммировать таймер Пуск и Timer Off.

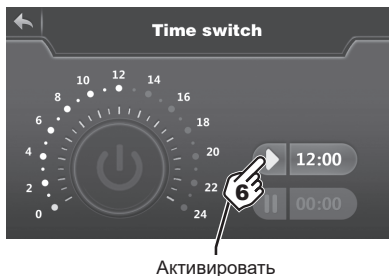
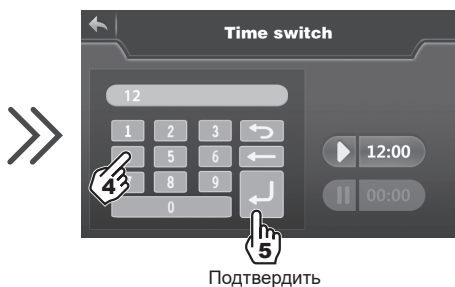
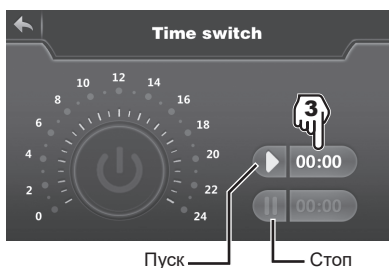
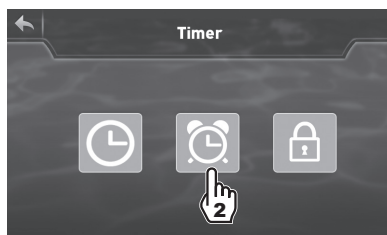

4. ИНТЕРФЕЙС ПОЛЬЗОВАТЕЛЯ (продолжение)



Сверхъяркий синий = Активировано
Серый = Деактивировано



Шаг настройки — «почасовой».



- После настройки времени пуска, нажмите на  (этап 6), чтобы активировать Таймер. Символ и время загорятся сверхъярким синим цветом.
- Вернуться к этапам 3–6 для настройки и активирования времени остановки ( 00:00).
- После завершения настроек, рабочий диапазон теплового насоса загорится сверхъярким зеленым, а диапазон выключения — сверхъярким желтым цветом.
- Нажмите 2 раза на , чтобы вернуться на главный экран.

4. ИНТЕРФЕЙС ПОЛЬЗОВАТЕЛЯ (продолжение)

4.4 Установка и визуализация заданного значения



В Режиме "ВЫКЛ." и Режиме "ВКЛ."

Нажмите кнопку  для отображения заданного значения, затем нажмите на  или  для определения необходимого заданного значения.

Подтвердите, нажав на ; возврат на главный экран происходит автоматически.



Установка возможна с шагом 0,5 °С.



Чтобы избежать деформации жаровых трубок, рекомендуется никогда не превышать температуру 30°С.

4. ИНТЕРФЕЙС ПОЛЬЗОВАТЕЛЯ (продолжение)

4.5 Блокировка и разблокировка тактильного экрана

Контрольный экран автоматически блокируется через минуту (настройка по умолчанию).

Можно настроить время до автоматической блокировки в диапазоне от 1 до 10 минут или просто отменить эту функцию.



Автоматическая блокировка активирована

3) Настройте время в диапазоне от 1 до 10 минут. Автоматическое сохранение,

4) Нажмите 2 раза на , чтобы вернуться на главный экран.

5) Чтобы деактивировать автоматическую блокировку, нажмите на .

Чтобы разблокировать экран, нажимайте на экран в течение 2 с (не важно куда именно).

Введите код «22» и подтвердите, нажав на **EN**



4. ИНТЕРФЕЙС ПОЛЬЗОВАТЕЛЯ (продолжение)

4.6 Настройка функции бесшумного режима SILENCE

Режим тишины позволяет использовать тепловую помпу в экономном режиме и тишине в случае низкой нагревательной потребности (поддерживать температуру в бассейне или, если нужно, поддерживать тихий режим работы).

Эта функция может быть активирована/деактивирована вручную или с помощью таймера.

Активация режима вручную

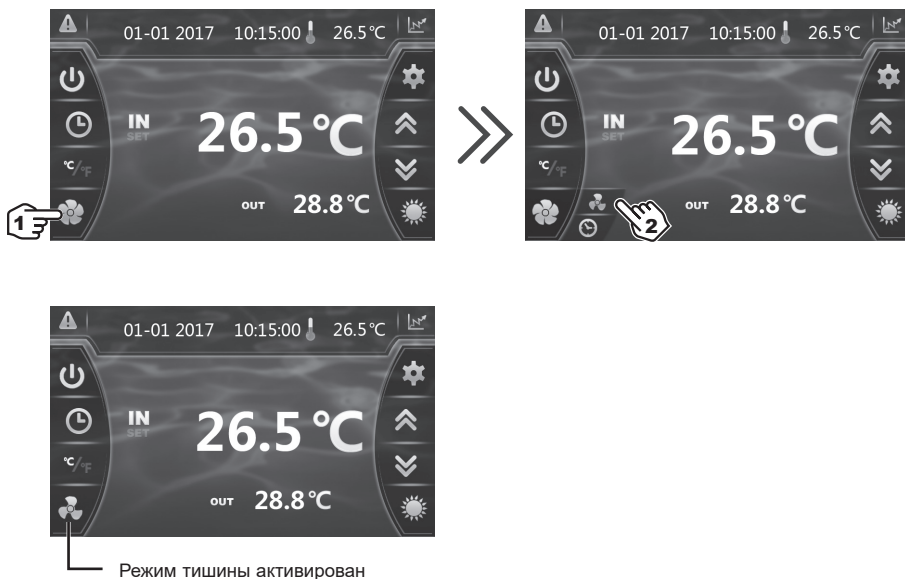

4. ИНТЕРФЕЙС ПОЛЬЗОВАТЕЛЯ (продолжение)

Отключение режима вручную

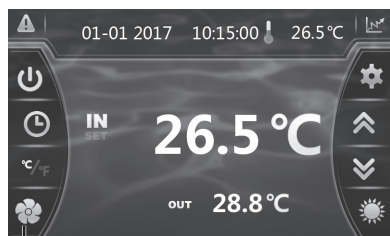

Режим тишины деактивирован

Настройка Таймера

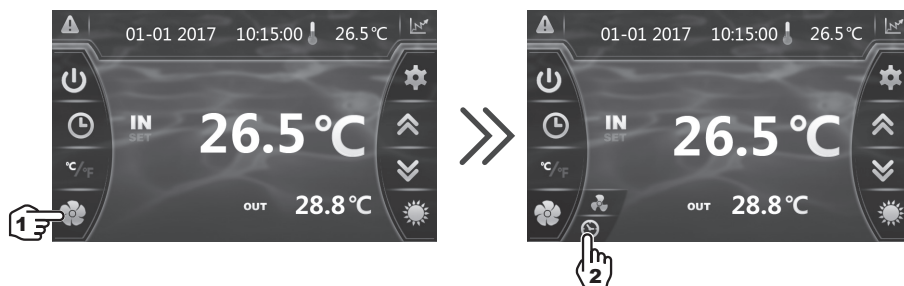

4. ИНТЕРФЕЙС ПОЛЬЗОВАТЕЛЯ (продолжение)

Настройка Таймера (продолжение)

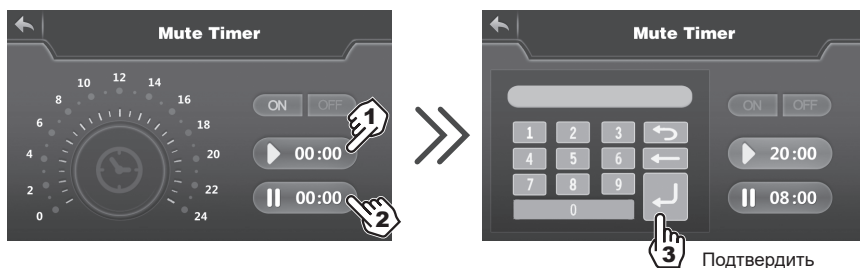

- 1) Время начала, введения и подтверждения.
- 2) Время завершения, введения и подтверждения.
- 3) Подтвердить.

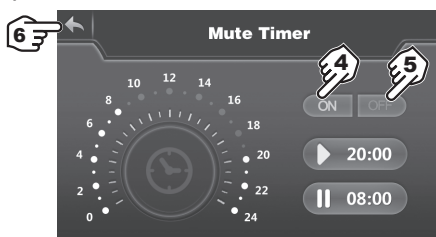

- 4) Активация.
- 5) Дезактивация.
- 6) Возврат к главному экрану.



Шаг настройки — «почасовой».

После активации Таймер действует круглосуточно 7 дней в неделю.

5. ТЕХНИЧЕСКОЕ ОБСЛУЖИВАНИЕ И КОНСЕРВАЦИЯ НА ЗИМУ

5.1 Техническое обслуживание

Для гарантирования продолжительной и надежной работы теплового насоса рекомендуется раз в год проводить следующие операции по обслуживанию устройства.

- Очистите испаритель с помощью мягкой зубной щетки или воздушной/водяной струи (**Внимание: никогда не используйте для очистки высокое давление**).
- Проверьте, что конденсат хорошо стекает.
- Проверьте надежность гидротехнических и электрических соединений.
- Проверьте гидравлическую герметичность конденсатора.
- Проверку изоляции холодильной системы выполняет уполномоченный специалист с помощью детектора течи.



Перед производством любых работ по техническому обслуживанию теплового насоса необходимо отсоединить его от источника питания. Все операции по техническому обслуживанию должны производиться только специально подготовленным персоналом, имеющим опыт работы с жидкими хладагентами.

5.2 Консервация на зиму

- Переведите тепловой насос в режим "ВЫКЛ."
- Отключите тепловой насос от источника питания.
- Слейте содержимое конденсатора для предотвращения риска повреждения (риск возможного замерзания).
- Закройте "перепускной" вентиль и отсоедините штуцерные соединения входа/выхода.
- С помощью пистолета высокого давления максимально выдуйте остатки воды из конденсатора.
- Перекройте вход и выход для воды теплового насоса для предотвращения попадания туда инородных тел.
- Укройте тепловой насос предназначенным для этих целей зимним чехлом.



Любые неполадки, вызванные неправильной консервацией на зимний период, аннулируют гарантию.

6. ПРИЛОЖЕНИЯ

6.1 Электрические схемы

ENP14M

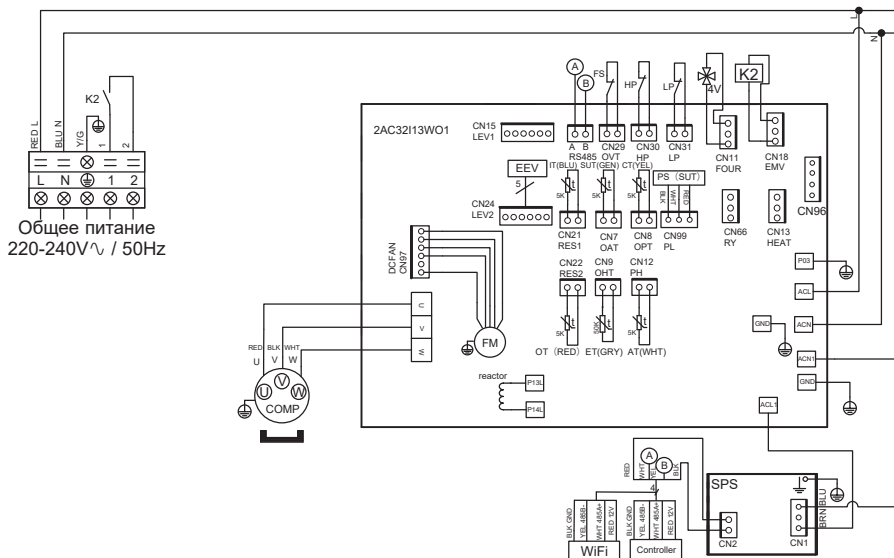

ПРИМЕЧАНИЯ

AT : ДАТЧИК ТЕМПЕРАТУРЫ ВОЗДУХА
COMP : КОМПРЕССОР
СТ : ДАТЧИК ТЕМПЕРАТУРЫ ИСПАРИТЕЛЯ
EEV : ЭЛЕКТРОННЫЙ РЕДУКТОР
FM : МОТОР ВЕНТИЛЯТОРА
FS : ДЕТЕКТОР НАЛИЧИЯ ВОДЫ
HP : ПРЕССОСТАТ ВЫСОКОГО ДАВЛЕНИЯ
IT : ДАТЧИК ТЕМПЕРАТУРЫ ВОДЫ НА ВХОДЕ

LP : ПРЕССОСТАТ НИЗКОГО ДАВЛЕНИЯ
OT : ДАТЧИК ТЕМПЕРАТУРЫ ВОДЫ НА ВЫХОДЕ
SUT : ДАТЧИК ТЕМПЕРАТУРЫ ВСАСЫВАНИЯ
4V : 4-Х КАНАЛЬНЫЙ ВЕНТИЛЬ
K2 : СВОБОДНЫЙ КОНТАКТ С МАКСИМАЛЬНЫМ ПОТЕНЦИАЛОМ 16А
ET : ДАТЧИК ТЕМПЕРАТУРЫ НАГРЕТАНИЯ
PS : ДАТЧИК ДАВЛЕНИЯ

6. ПРИЛОЖЕНИЯ (продолжение)

ENPI6M

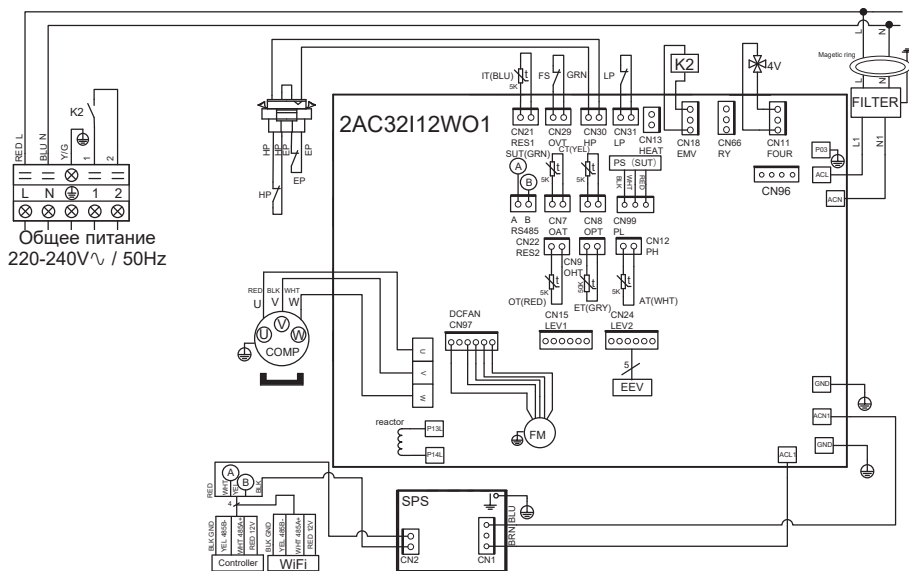

ПРИМЕЧАНИЯ

AT : ДАТЧИК ТЕМПЕРАТУРЫ ВОЗДУХА
COMP : КОМПРЕССОР
CT : ДАТЧИК ТЕМПЕРАТУРЫ ИСПАРИТЕЛЯ
EEV : ЭЛЕКТРОННЫЙ РЕДУКТОР
FM : МОТОР ВЕНТИЛЯТОРА
FS : ДЕТЕКТОР НАЛИЧИЯ ВОДЫ
HP : ПРЕССОСТАТ ВЫСОКОГО ДАВЛЕНИЯ
IT : ДАТЧИК ТЕМПЕРАТУРЫ ВОДЫ НА ВХОДЕ

LP : ПРЕССОСТАТ НИЗКОГО ДАВЛЕНИЯ
OT : ДАТЧИК ТЕМПЕРАТУРЫ ВОДЫ НА ВЫХОДЕ
SUT : ДАТЧИК ТЕМПЕРАТУРЫ ВСАСЫВАНИЯ
4V : 4-Х КАНАЛЬНЫЙ ВЕНТИЛЬ
K2 : СВОБОДНЫЙ КОНТАКТ С МАКСИМАЛЬНЫМ ПОТЕНЦИАЛОМ 16А
ET : ДАТЧИК ТЕМПЕРАТУРЫ НАГРЕТАНИЯ
PS : ДАТЧИК ДАВЛЕНИЯ

6. ПРИЛОЖЕНИЯ (продолжение)

6.2 Включение подогрева в качестве приоритета

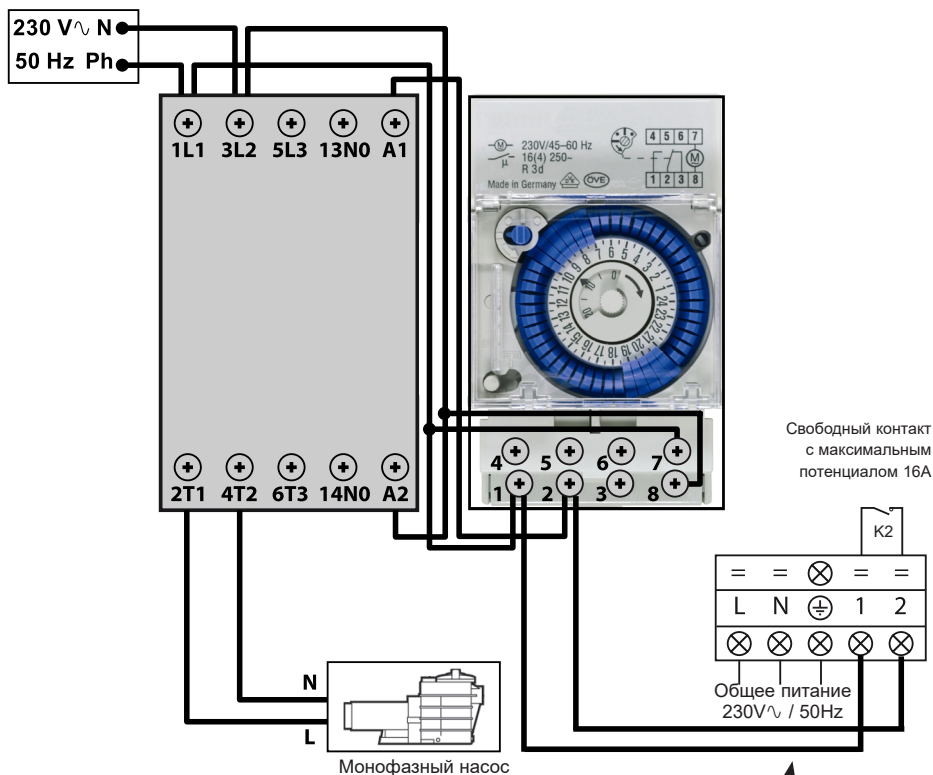

Разъемы 1 и 2 обеспечивают подачу питания на бесполярный контакт при напряжении 230V \sim / 50Hz. Подключите кабели к разъемам 1 и 2 в соответствии с указанной монтажной схемой для автоматической регулировки насоса фильтрации по циклам в 2 минуты каждый час, когда температура резервуара снижается ниже установленного значения.

 **Никогда не подключать питание фильтрационного насоса прямо к клеммам 1 и 2.**



Намеренно оставлено пустым

6. ПРИЛОЖЕНИЯ (продолжение)

6.3 Вид в разборе и съемные элементы

ENPI4M / ENPI6M

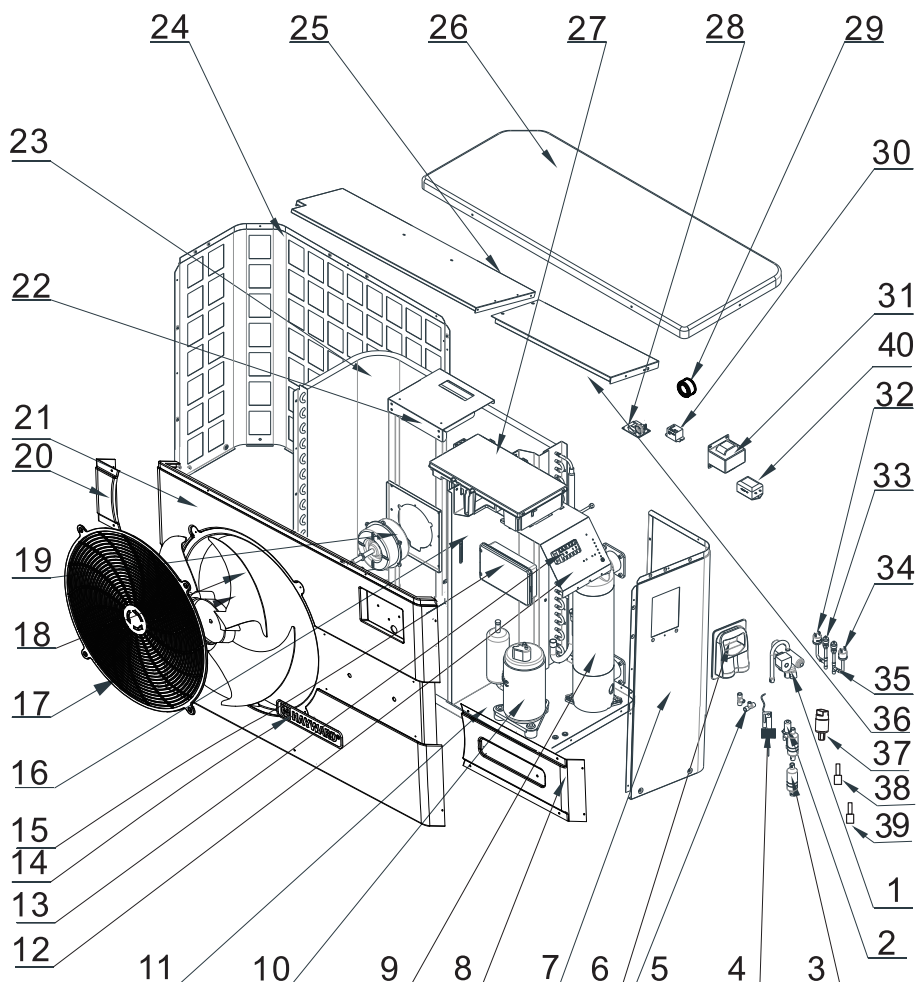

6. ПРИЛОЖЕНИЯ (продолжение)

ENPI4M / ENPI6M

Индикатор	Название	Справочный номер	ENPI4M	ENPI6M
1	4-ходовой клапан	HWX20041437	✓	✓
2	Электронный редуктор	HWX81000015	✓	нет данных
		HWX81000016	нет данных	✓
3	Фильтр ø9.7-ø9.7 (Ø28)	HWX20041444	✓	✓
4	Детектор пропускной способности	HWX83000012	✓	✓
5	T-образный коннектор ø9.52-2 x ø6.5(T) x 1.0	HWX304030000002	✓	✓
6	Трапп автоматизированные	HWX320922029	✓	✓
7	Правая панель	HWX80700455	✓	✓
8	Правая декоративная панель	HWX80900089	✓	✓
9	Конденсатор Titane/ПВХ	HWX80600074	✓	нет данных
		HWX80600096	нет данных	✓
10	Компрессор	HWX20000110448	✓	нет данных
		HWX80100003	нет данных	✓
11	/	/	/	/
12	/	/	/	/
13	Переходник, L-N-GND -5-х контактный 4mm ²	HWX40003901	✓	✓
14	Логотип HAYWARD	HWX20000230596	✓	✓
15	Цветной сенсорный экран	HWX95005310612	✓	✓
16	/	/	/	/
17	Защитная сетка вентилятора	HWX20000220169	✓	✓
18	Винт вентилятора	HWX20000270004	✓	✓
19	Мотор вентилятора DC	HWX20000330132	✓	✓
20	Левая декоративная панель	HWX80900088	✓	✓
21	Панель передняя	HWX80900087	✓	✓
22	Опора двигателя	HWX80700248	✓	✓
23	Пластинчатый испаритель	HWX80600044	✓	нет данных
		HWX80600100	нет данных	✓
24	Левая панель	HWX80700455	✓	✓
25	/	/	/	/
26	Верхняя панель	HWX301090200806	✓	✓
27	Управляющая электронная плата	HWX82300008	✓	нет данных
		HWX82300007	нет данных	✓
28	Трансформатор 230 В~/12 BDC	HWX82600008	✓	✓
29	/	/	/	/
30	Реле K2	HWX20000360297	✓	✓
31	Катушка 20 А 50 Гц 5 мГн	HWX82500005	✓	✓
32	Реле низкого давления NO 0.30MPa/0.15MPa	HWX20000360157	✓	✓
33	Замер давления 40 мм 1/2 дюйма	HWX20000140150	✓	✓
34	Реле высокого давления NC 3.2MPa/4.4MPa	HWX20013605	✓	✓
35	T-образный коннектор ø6.5-2 x ø6.5(T) x 0.75T2M	HWX20001460	✓	✓
36	/	/	/	/
37	Датчик давления	HWX20000360123	✓	✓
38	датчик нагнетания компрессора 50 кΩ-660mm	HWX83000026	✓	✓
39	Датчик температуры воздуха 5к-350mm	HWX83000049	✓	✓
	Воды на выходе зонда 5к-410mm	HWX83000050	✓	✓
	Воды на входе зонда 5к-850mm	HWX83000052	✓	✓
	Датчик всасывания компрессора 5к-560mm	HWX83000044	✓	✓
	Датчик размораживания 5к-680mm	HWX83000051	✓	✓
40	Фильтр EMC	HWX20003257	нет данных	✓

6. ПРИЛОЖЕНИЯ (продолжение)

6.4 Справочник по устранению неисправностей



Некоторые операции должны выполняться квалифицированными специалистами.

В случае проблем с тепловым насосом в левом углу  экрана загорится красный мигающий символ.

Нажмите на символ  чтобы получить доступ к списку ошибок.

В случае неисправности следующие индикаторы появятся на экране:

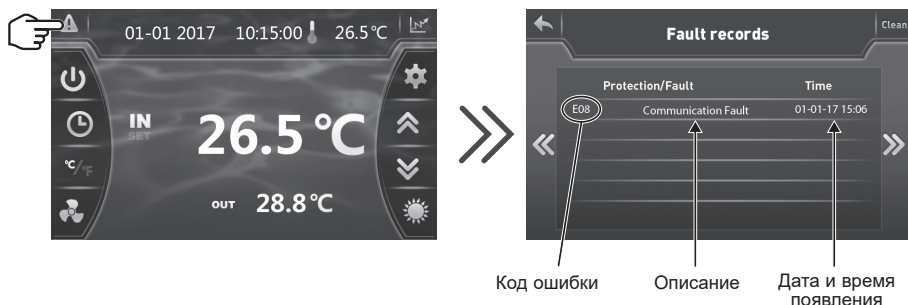

После решения проблемы ошибка исчезнет автоматически, треугольник станет серым.



*Чтобы очистить список ошибок, нажмите на **Clean** чтобы вернуться на предыдущий экран.* 

6. ПРИЛОЖЕНИЯ (продолжение)

Неисправности	Коды ошибок	Описание	Устранение
Неисправность датчика воды на входе	P01	Датчик открыт или произошло короткое замыкание.	Проверьте соединение CN21/RES1 на плате и удлинитель или замените датчик.
Неисправность датчика воды на выходе	P02		Проверьте соединение N22/RES2 на плате и удлинитель или замените датчик.
Неисправность датчика оттаивания	P04		Проверьте соединение CN12/PH на плате и удлинитель или замените датчик.
Неисправность датчика температуры окружающей среды	P05		Проверьте соединение CN8/OPT на плате и удлинитель или замените датчик.
Отсутствие зонда всасывания компрессора	P07		Проверьте соединение CN7/OAT на плате и удлинитель или замените датчик.
Отсутствие зонда нагнетания компрессора	P081		Проверьте соединение CN9/OHT на плате и удлинитель или замените датчик.
Защита от высокого давления	E01	Датчик открыт или произошло короткое замыкание.	Проверьте соединение CN30/HP на карте или замените датчик
			Проверьте расход воды
			Проверьте датчик расхода воды
			Проверьте открытие вентилялей
			Проверьте перепускную систему
			Проверьте засорение испарителя
			Температура воды слишком высокая
Защита от низкого давления	E02	Датчик открыт или произошло короткое замыкание.	Проблема с конденсатом после обслуживания, опорожните и извлеките сухую холодильную систему
			Слишком большое количество жидкости в системе, удалите жидкость в емкости с жидкостью
			Проверьте соединение AI/DI03 на карте или замените датчик
			Значительная утечка охлаждающей жидкости, найдите течь с помощью детектора
Неисправность детектора пропускной способности	E03	Датчик открыт или произошло короткое замыкание.	Низкое количество поступающего воздуха, проверьте скорость вращения вентилятора
			Проверьте засорение испарителя, очистите его поверхность
			Проверьте соединение AI/DI02 на карте или замените датчик
			Нехватка воды, проверьте работу фильтрационной помпы
			Проверьте, открыты ли стопорные вентили
			Проверьте регулировку перепускной системы

6. ПРИЛОЖЕНИЯ (продолжение)

Неисправности	Коды ошибок	Описание	Устранение
Разница температур на входе/выходе > 13 °С	E06	Применяется только в режиме охлаждения	Нехватка воды, проверьте работу фильтрационной помпы
			Проверьте, открыты ли стопорные вентили
			Проверьте регулировку перепускной системы
Защита от замерзания Холодный режим	E07	Количество воды на выходе слишком мало.	Проверить пропускную способность или датчик температуры воды на выходе.
Сбои в передаче информации	E08	Нет соединения между электронной платой и пользовательским интерфейсом	Проверьте соединения — см. схему соединений.
Защита от замерзания - уровень 1	E19	2° < температура воды < 4° и температура воздуха < 0°	Остановите работу теплового насоса, слейте конденсатор, чтобы избежать замерзания; по умолчанию тепловой насос запускает фильтрационный насос для предотвращения замерзания
Защита от замерзания - уровень 2	E29	Температура воды < до 2° и температура воздуха < 0°	Остановите работу теплового насоса, слейте конденсатор, чтобы избежать замерзания; по умолчанию тепловой насос запускает фильтрационный насос и тепловой насос для предотвращения замерзания.
Неисправность двигателя вентилятора	F031	Двигатель заблокирован или есть проблема с соединением	Проверьте свободное вращение; проверьте соединение CN97/DCFan; замените двигатель
Неисправность двигателя вентилятора	F051	Ошибка соединения	Проверьте соединение DCFAN/CN97; замените двигатель
Наружная температура слишком низкая	TP	Рабочий предел достигнут	Выключите тепловой насос
Сбой в работе датчика давления	PP	Датчик открыт или произошло короткое замыкание	Проверьте соединение (см. электрическую схему)

6. ПРИЛОЖЕНИЯ (продолжение)

6.5 Регистрация данных

На главном экране нажмите на  чтобы получить доступ к истории регистраций температуры воды на входе и выходе.



Эти данные доступны в течение 60 дней.

Нажмите на  чтобы получить доступ к средней потребляемой электрической мощности.

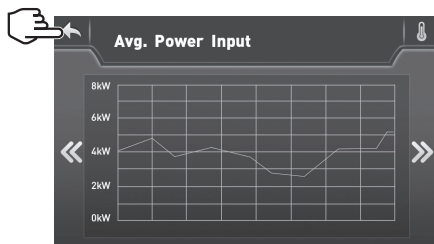
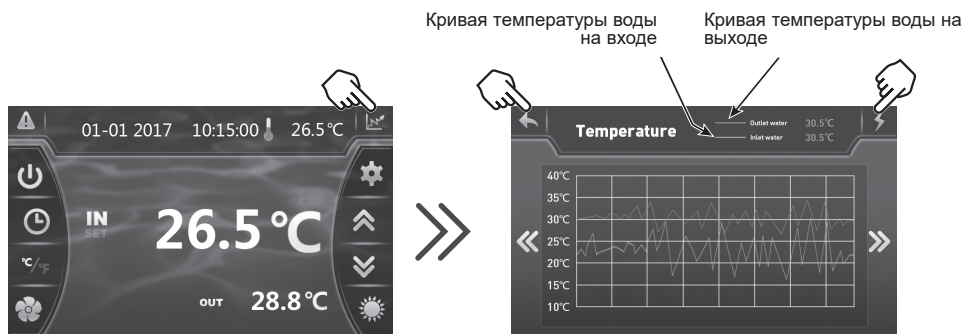

Нажмите на  чтобы вернуться на главный экран.

6. ПРИЛОЖЕНИЯ (продолжение)

6.6 Гарантия

ГАРАНТИЙНЫЕ ОБЯЗАТЕЛЬСТВА

На всю продукцию компании HAYWARD в течение двух лет с момента приобретения распространяется гарантия отсутствия дефектов, связанных с работой или материалами. Настоящая гарантия действительна лишь при предъявлении документа, подтверждающего факт и дату покупки. В связи с этим мы рекомендуем сохранять товарный чек.

Гарантия компании HAYWARD сводится лишь к ремонту или замене, по выбору компании HAYWARD, дефектного изделия при условии его нормальной эксплуатации в соответствии с требованиями инструкции по эксплуатации, отсутствия каких-либо модификаций изделия и использования компонентов и запасных частей исключительно компании HAYWARD.

Действие гарантии не распространяется на последствия воздействия мороза и химических веществ. Все прочие расходы (доставка, производство работ, ...) не включены в гарантию.

Компания HAYWARD не несет ответственности за любой ущерб, прямой или косвенный, являющийся следствием неправильной установки, подключения или работы изделия.

Для того чтобы воспользоваться гарантией и потребовать возмещения стоимости или замены изделия, обратитесь к Вашему продавцу. Возврат изделия на завод-изготовитель невозможен без нашего предварительного письменного согласия. Гарантия не распространяется на быстроизнашивающиеся детали.



HAYWARD POOL EUROPE

Parc Industriel de la Plaine de l'Ain
Allée des Chênes
01150 Saint-Vulbas
France
<http://www.hayward.fr>

